

HF/50MHz Transceiver

FT DX 5000 Series



The radio... YAESU
Choice of the World's top DX'ersSM

The Answer ...

Equipped with Extra Sharp 6-pole Crystal Roofing Filters The New Premium HF/50 MHz Transceiver

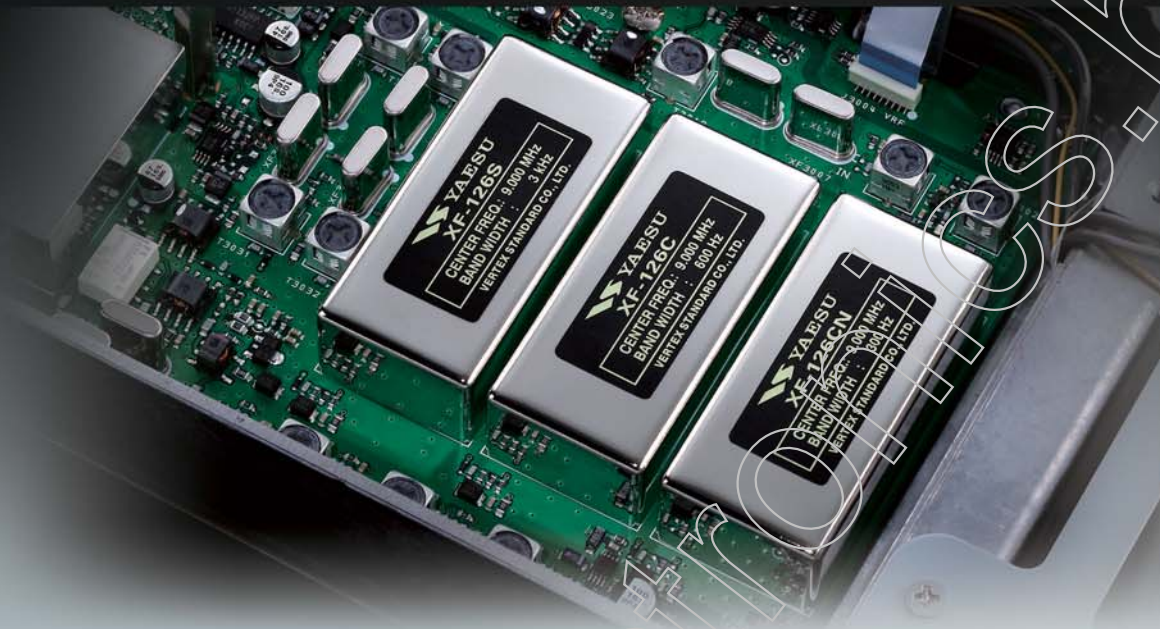

The Newly designed 9 MHz 1st IF of the FT DX 5000 main receiver implements sharp 6-pole* crystal roofing filters. *8-pole / 3 kHz Superior close-in dynamic range affords the serious DX'er the best performance possible.

Additionally: a Dual Quad Double Balanced Mixer for the main RX/front end, 2SC4536 (NE46134) designed for use in the RF amp in series, VRF (Variable RF Preselector) system with up to 62 steps and 15 fixed bandpass filters (BPF), and High-level 400 MHz HRDDS (High Resolution Direct Digital Synthesizer) system for outstanding local oscillator (LO) performance, have been deployed for the ultimate weak signal reception performance in strong signal environments. Improved 3rd-Order Dynamic Range, and Superb IP3 (3rd-Order Intercept Point) – 112 dB, +40 dBm at 10 kHz separation, and 105 dB, +36 dBm at the most practical 2 kHz separation! (CW / 500 HzBW, R.FIL 600 Hz, IPO1 : VFO-A/Main Receiver @ 14 MHz)

Enjoy the superb and astonishing dynamic range of 112dB, IP3 +40dBm at 10 kHz separation (CW/500 Hz BW, IPO1).

Newly designed sharp 6-pole Crystal Roofing Filters – the 1st IF

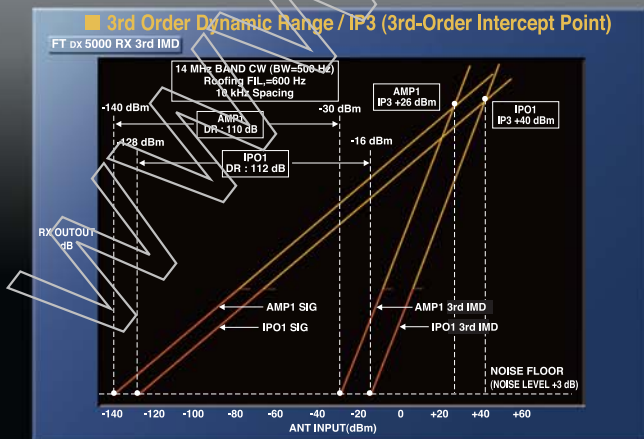

Newly designed sharp 6-pole Crystal Roofing Filters producing excellent shape factor for VFO-A/Main Receiver, selectable between 300 Hz (optional/included in MP), 600 Hz (6-pole crystal filters), 3 kHz (8-pole crystal filters), 6 kHz, and 15 kHz (4-pole MCFs), optimized by mode for best performance, have been prepared for serious DX operation. Enjoy the incomparable crisp and sharp 300 Hz narrow filter on today's crowded bands!

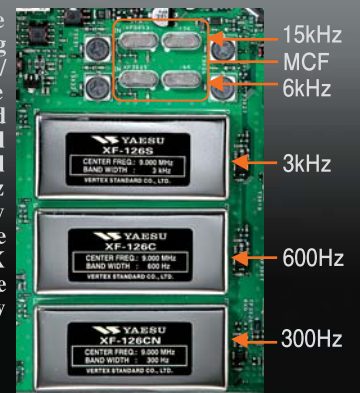

Front End Block Diagram

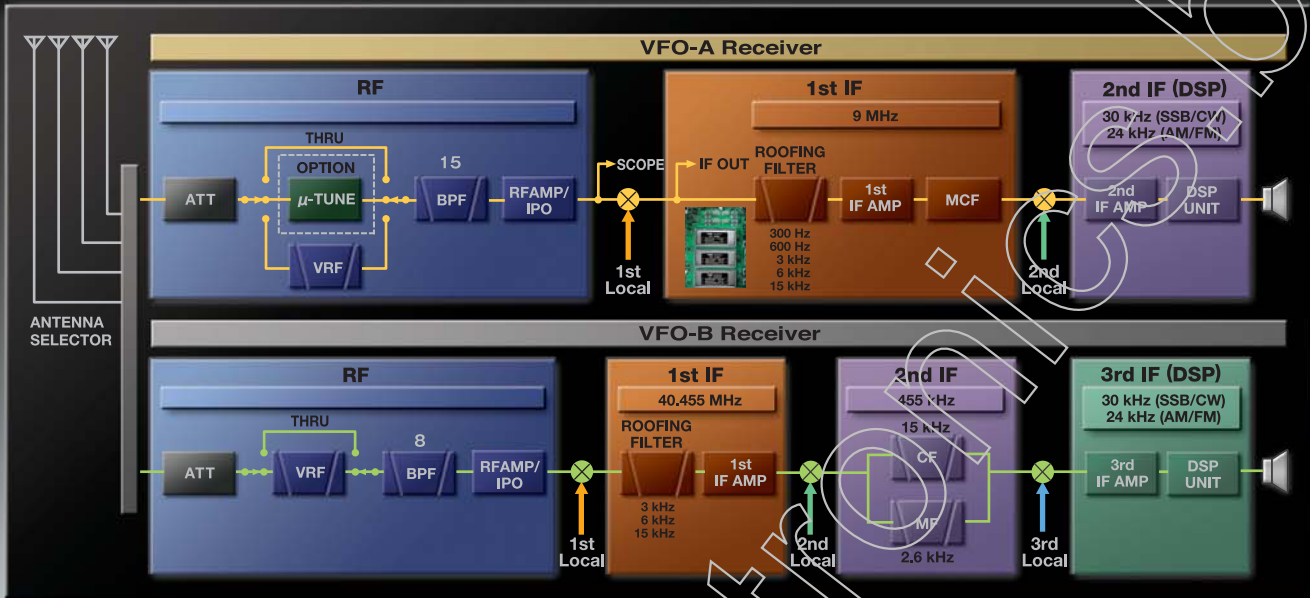

You will appreciate the totally independent Second Receiver (VFO-B).

The 40.455 MHz 1st IF up-conversion design, with Yaesu's original VRF and bandpass filter system, the low noise and high gain 2SC3357 transistors used in series for the RF amp, the 4 x 3SK294 Double-balanced 1st mixer, and the 3 kHz/6 kHz/15 kHz selectable roofing filters (MCF), complement the high performance main receiver.

The receivers are completely independent.

Needless to say, you will enjoy the legendary high performance of Yaesu Custom-designed DSP independently, that is you have two high quality separate receivers for the same band (in-band dual receive), or receive two different frequency bands, or simultaneous TX and RX receive split frequency operation, for superior HF operation.

Characteristics and frequency response of Roofing Filters

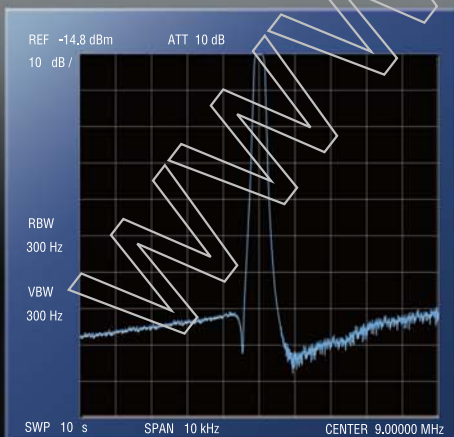

300 Hz

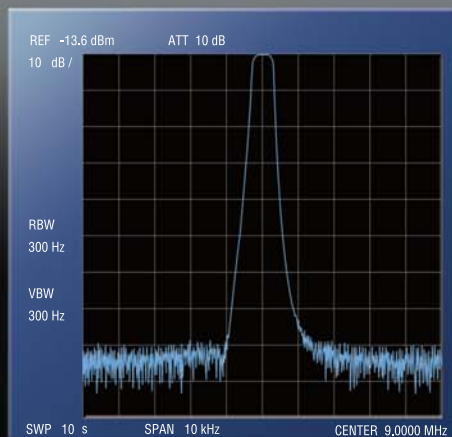

600 Hz

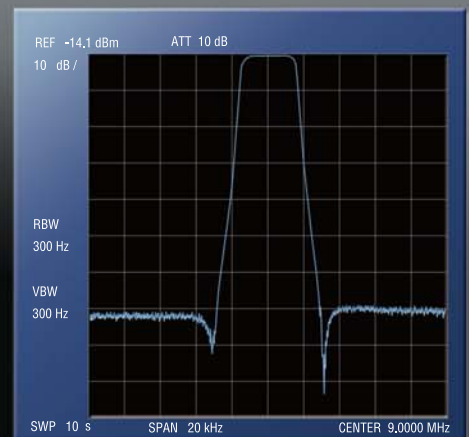

3 kHz

The completely new “4 selectable IPO positions” for various antennas and band conditions!

The 2SC4536 (NE46134) in the series RF amplifier design, produce a low distortion and low noise figure RF amplifier, which allows the receiver to perform at it’s best under the most diverse operating conditions.

The new IPO System allows selection of four RF gain set-up conditions from the front panel. Choose IPO1 to feed a signal level to the mixer for the best possible IP performance. Choose IPO2 for no RF amplification. Choose AMP1 (+10 dB) to maintain standard sensitivity, or AMP2 (+17 dB) to have both RF amps in series, for the highest sensitivity.



RF Amp

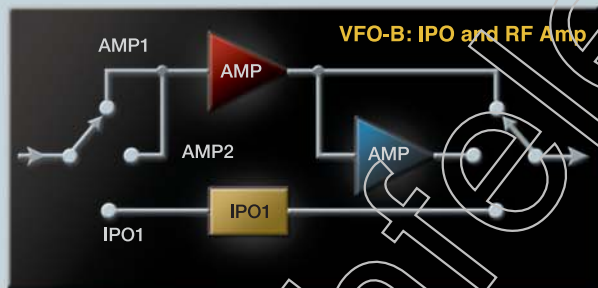
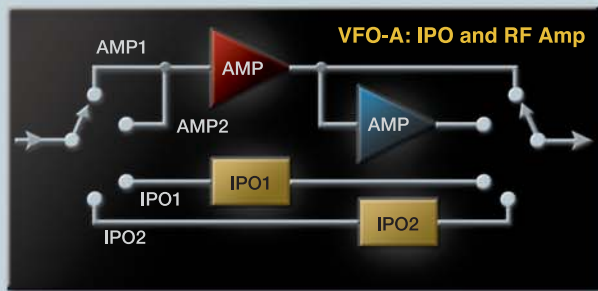

Selectable Front-end attenuator (0/-6/-12/-18dB)

The Double Quad Double Balanced Mixer system – Obtaining the best performance for your ultimate DX operation

Eight, 3SK294 Dual Gate MOS FETs are employed for the 1st mixer in a 2 x 4 configuration to establish the Double Quad Double Balanced Mixer. The Double Balanced Mixers using FETs have low losses by themselves so there is no need to obtain more gain than is required at the RF amp, resulting in the best desirable design for the RF Front End.

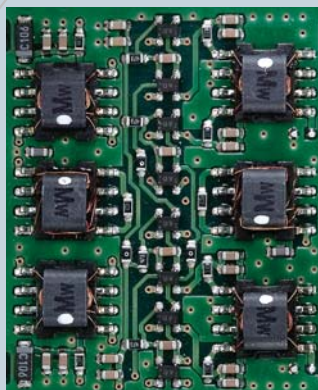

Mixer Unit

The uncompromised 400 MHz HRDDS (High Resolution Direct Digital Synthesizer) system for the high quality local oscillator

In seeking to improve the strong-signal-handling capabilities of the receiver section, ultra-low-noise local oscillator system that produces a very clean 1st IF signal is essential. The high Carrier-to-Noise (C/N) ratio of the 400 MHz HRDDS (High Resolution Direct Digital Synthesizer) system that was implemented in the FT DX 9000 Series, has also been employed in the FT DX 5000 Series.

The HRDDS system utilizes a direct locking technique using a 400 MHz reference signal, resulting in a lock time that approaches zero; because the lock time is zero, the inversely-related C/N ratio has no degradation close-in, resulting in unprecedented maintenance of the signal-to-noise ratio close to your operating frequency, and the BDR (Blocking Dynamic Range) performance follows suit.

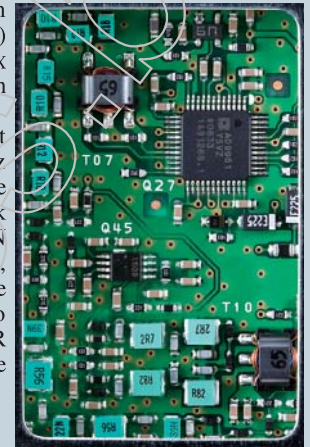

DDS Unit

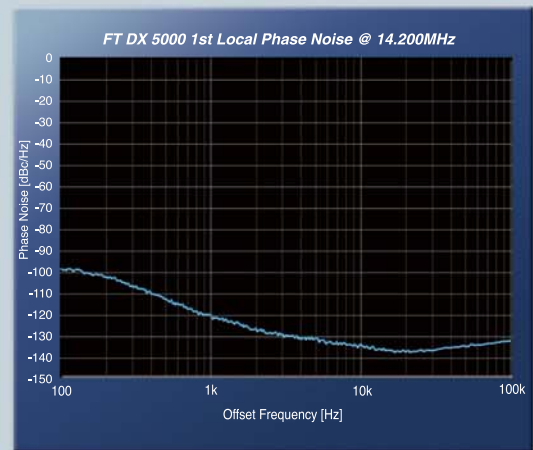
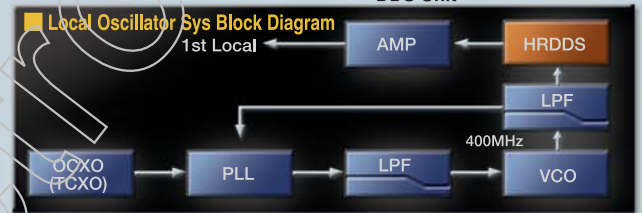

C/N Ratio Performance

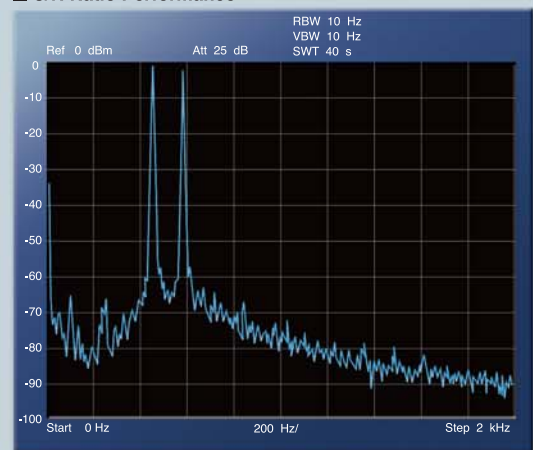

RX=14,200 MHz
CW-USB
IPO1
9MFIL=300 Hz
DSPFIL=300 Hz
AGC=SLOW
PITCH=500 Hz

In-band-IMD

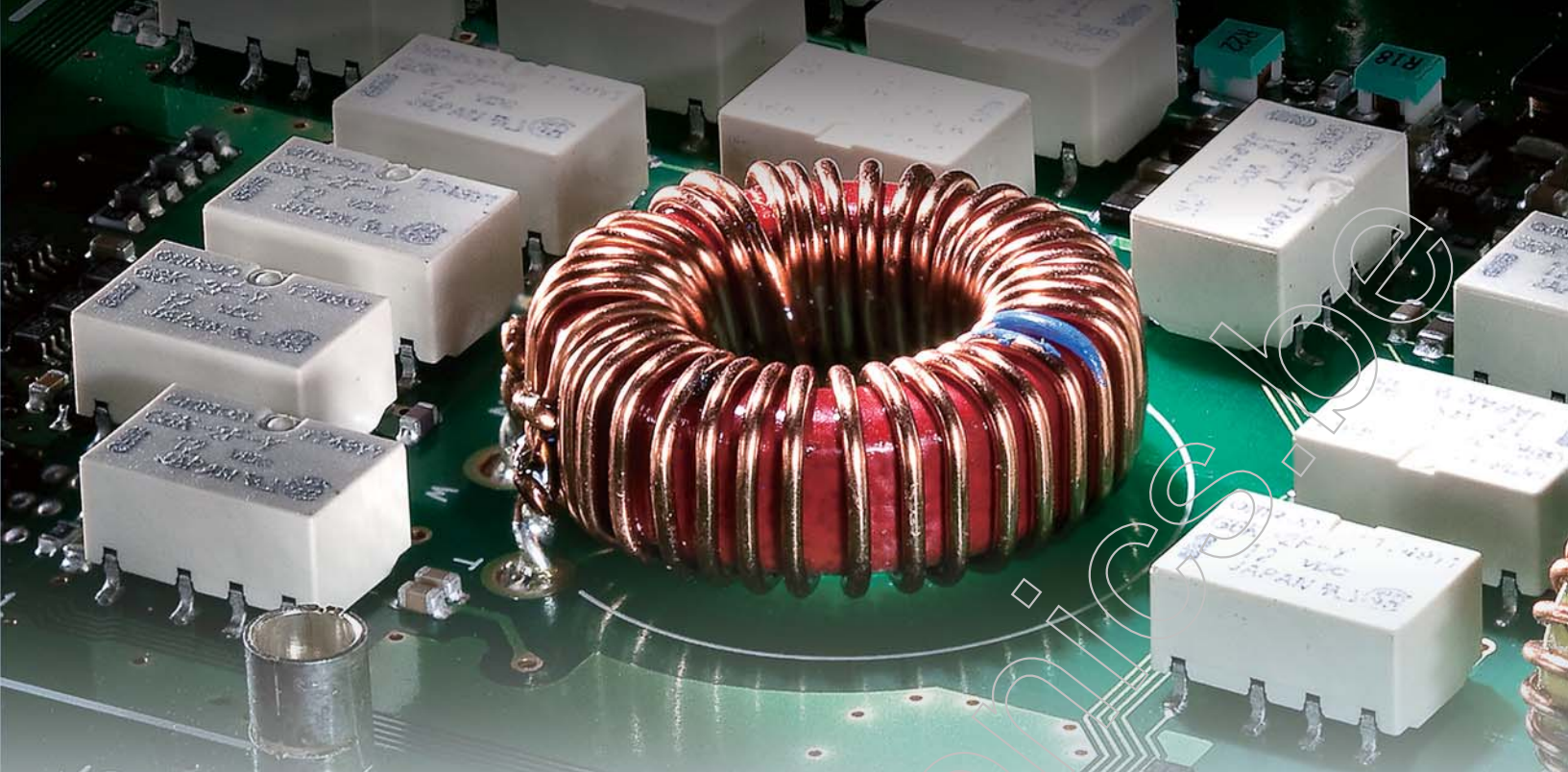

Variable RF Filter (VRF) VRF – Covering the 1.8 - 28 MHz

To provide protection for the RF stages, as well as the two IF stages, the front end filtering system utilizes a combination of 15 fixed bandpass filters and Yaesu's exclusive VRF (Variable RF) Preselector system. Those two RF filter systems protect the early stages of the receiver from overload caused by strong out-of-band signals. The high-Q VRF system is much narrower in bandwidth than the fixed bandpass filters, and it is crafted using high-permeability toroidal coils (T-80 and T-37 type) and tuning capacitors, producing 62 tuning steps for optimal rejection of broadcast or commercial-service interference. The robust circuit design utilizes expensive sealed surface-mount relays, capable of sustaining surges of up to 2500 Volts down the antenna line. The center frequency of the VRF is manually adjustable, allowing you to skew the filter response for maximum rejection of the undesired signals.

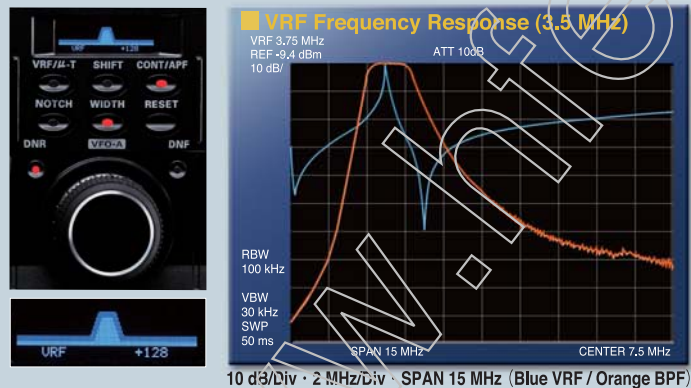

15 amazingly tough band pass filters!

15 band pass filters (8 x Amateur Radio band + 7 x General Coverage Receive) are inserted between the VRF and the RF amp stages, and automatically selected for the frequency band in use, to eliminate unwanted out-of-band signals.



Bandpass Filter Unit (Amateur Radio band)

Dual Receive (In-band) function – Totally independent receivers Simultaneous reception (different-band/same-band, TX/RX split operation)

The FT DX 5000 sub receiver is completely independent and separate from the main receiver, including AGC. It is engineered as a 40.455 MHz 1st IF up-conversion/triple-conversion superheterodyne receiver. It is also fortified with the VRF and BPF system front end, the 2SC3357 in series RF amp, the QDBM using 3SK294 1st IF Mixer, and the 3 Roofing filters (3 kHz/6 kHz/15 kHz). Indeed, you have another high quality receiver inside the same radio! You will also enjoy the legendary Yaesu 32-bit floating IF DSP with true DSP WIDTH, SHIFT, DNR, CONTOUR, DNF and NOTCH functions just as you do with the main receiver!

Contest-ready Antenna Selection Capabilities

With complicated and fast-moving contest operation in mind, four TX/RX antenna jacks, and one RX only jack are provided on the rear panel. One-touch directs access to any antenna. A custom external band pass filter or preamplifier may be connected between the RX ANT OUT and RX ANT IN jacks. The antenna selection is memorized in each VFO and memory channel register so that you do not need to switch antennas when changing VFOs. The radio remembers which antenna you last used on that band or memory frequency channel!

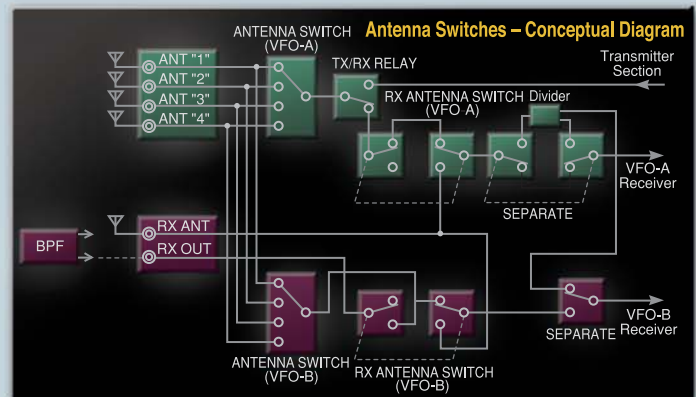

The 32-bit Floating Point IF Digital Signal Processing System

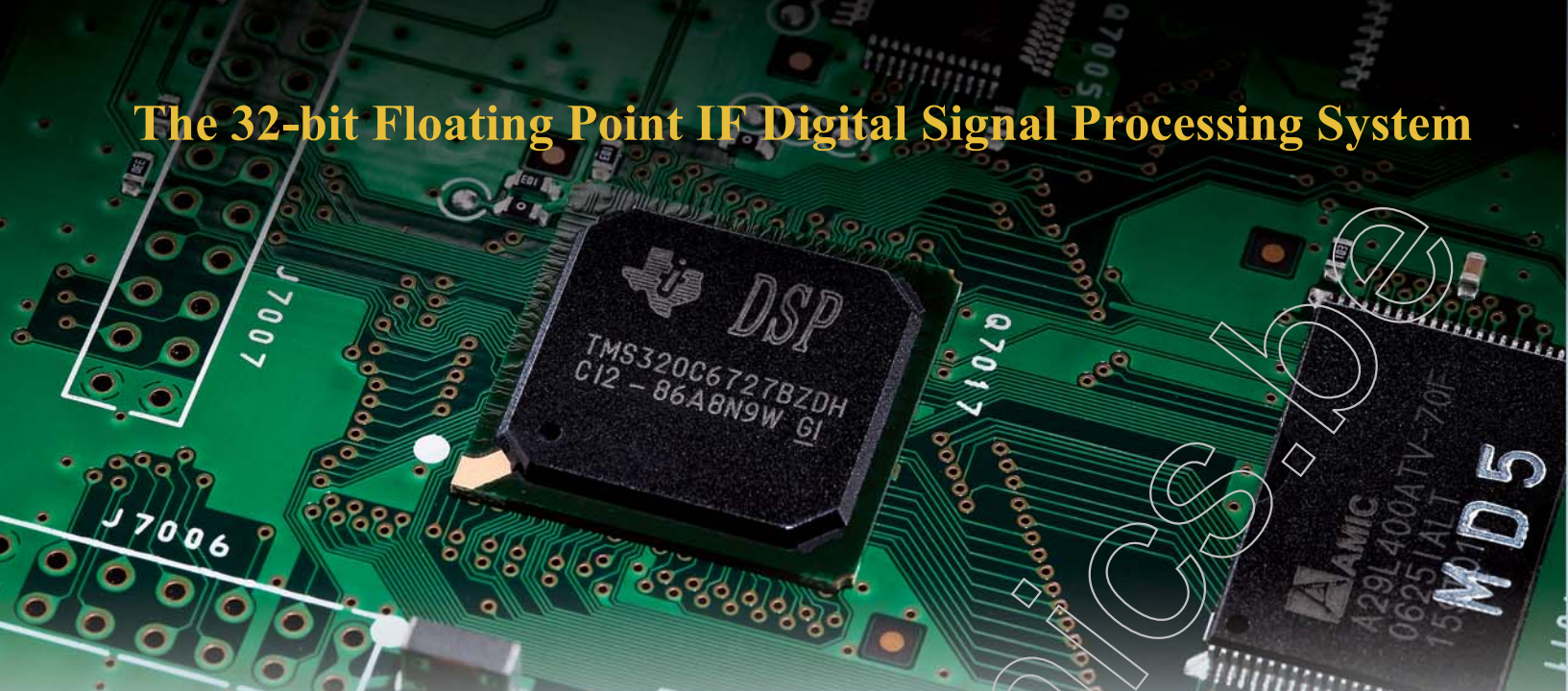

The legendary high performance Yaesu Custom-designed 32-bit Floating Point DSP based on the TI TMS320C6727B (@300 MHz), one each for VFO-A and VFO-B.

World-renowned Variable IF WIDTH / IF SHIFT Interference Reduction Systems

While leaving the pitch of the incoming signal and bandwidth of the IF passband unchanged, the IF Shift system allows you to vary the actual passband higher or lower in frequency, eliminating interference that you encounter outside the passband. You can also improve your reception by choosing to narrow the bandwidth of the IF WIDTH function and then varying the passband with the IF SHIFT. The IF SHIFT control and the IF WIDTH control can be instantly swapped with each other using the switches above the VFO-A sub dial. The variable IF WIDTH system has a default center bandwidth of 2.4 kHz for SSB and CW, and 500 Hz for RTTY and PSK operation. By rotating the IF WIDTH control, the passband may be reduced to as little as 50 Hz on CW/RTTY/PSK, or 200 Hz on SSB. On the other hand, the SSB bandwidth may be expanded to 4000 Hz by simply rotating the IF WIDTH control clockwise if you would like a wider bandwidth for greater fidelity on SSB!

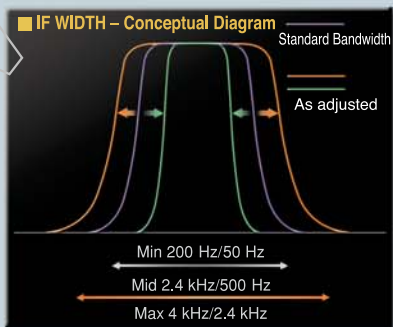
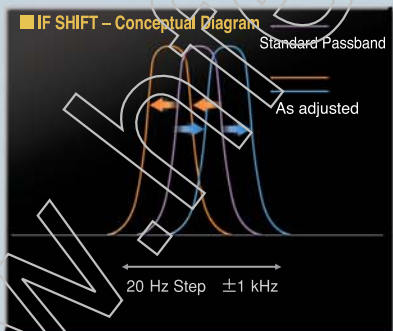

Passband Response CONTOUR Control with an Analog Touch

The incredibly sharp “brick wall” filters of the IF DSP system can expose characteristics of incoming signals that you have never heard before, and not all of them are really pleasant to listen to. Using the CONTOUR control, you can roll off low-frequency or high-frequency components to shape the receiver passband differently, or null out part of the mid-range area, with continuous adjustment throughout the passband. By nulling out interfering or irrelevant frequency components, the desired frequency components will significantly rise out of the background noise, improving fidelity and signal-to-noise (S/N) ratio. The CONTOUR control also functions as the APF (Audio Peak Filter) in conjunction with the CW pitch.

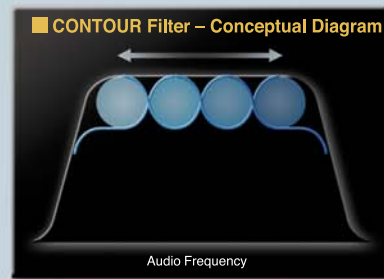

Manual IF Notch and Beat-reducing Automatic Digital Notch Filter (DNF)

The IF Notch features very high “Q”, and produces a deep notching effect typically in excess of 70 dB. Using the MENU mode, either a “Wide” or “Narrow” notch filter can be selected, depending on the interference profile you encounter. For reduction of multiple carriers within the passband, the DSP AUTO NOTCH (DNF) filter may be engaged, independently of the manual Notch Filter.

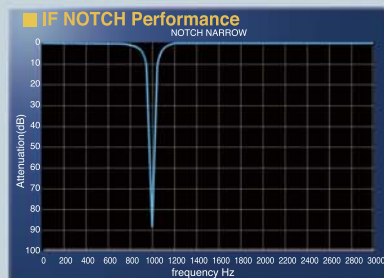

DSP Digital Noise Reduction

For reduction of random noise types, a powerful Digital Noise Reduction filter which utilizes 15 different analysis parameters, was created after thousands of hours of on-the-air testing. You may choose any of these parameters to most effectively reduce the noise, based on the conditions at any given time!

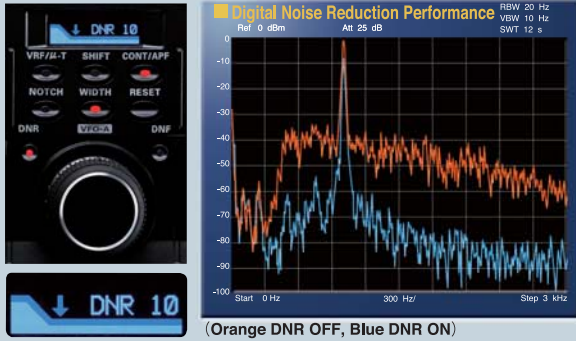

Oversized, Flywheel-effect, High-quality Main Tuning Dial

The front panel oversized 2.67" (68 mm) Main Tuning Knob is crafted using a heavy brass alloy (weight 8.7 oz / 248 g) for easy flywheel-effect frequency excursions, or precision tuning of weak digital signals. The precision magnetic rotary-encoder tuning mechanism is coupled to the Main Tuning Knob.

The torque of the tuning knob may be adjusted by rotating the Main Tuning Knob while holding the dial skirt, for just the amount of drag you prefer. This dial is the same structure as used on the FT DX 9000. The normal dial structure is fitted with a rotating skirt that creates small air gaps. These air gaps reduce sweat accumulation on the operator's fingertips, enhancing tuning precision during long operating sessions.

Newly Designed, Excellent Snap Action Tactile Feedback Toggle & Push Switches!

For changing antennas, ATT selections (ATT), IPO set-up (IPO), Roofing filters (R.FLT), and AGC, the newly ergonomic designed toggle and push switches are located under the main display on the front panel. You can change the parameters by moving the switch up/down, or return to the default parameter by pushing towards the front panel, ensuring fast and easy operation!



Clear Electro Luminescence displays support your operation!

The oversized highly visible main display on the front panel presents all the needed general information. Three newly designed EL (Electro Luminescence) displays maximize your operation with useful and tactical supportive information. The Sub-frequency, VRF (Main and Sub), IF SHIFT, IF WIDTH, CONTOUR, APF, and NOTCH settings can be observed at a glance! These sub displays are a "must-have" for easily adjusting MIC-GAIN, RF POWER, PROC-LEVEL, VOX-DELAY, PITCH, SPEED and BK-IN DLY.



The sub dial, positioned right next to the main dial, controls VFO-B (for up/down – frequency. The sub dial also supports VFO-A (for up/down – CLAR, Memory Channel and changing bands). The highly multi-functional design is easily operated with a single hand!



New-design Large-area OCXO Reference Oscillator

The 10 MHz OCXO (Oven Controlled Crystal Oscillator), with industry leading frequency stability rated at ± 0.05 ppm over the temperature range of $+14^{\circ}\text{F}$ to $+140^{\circ}\text{F}$ (-10°C to $+60^{\circ}\text{C}$), Serves as the master reference oscillator for the FT DX 5000MP. The super highly-stable OCXO Reference Oscillator, makes your radio ideal for PSK31, EME or DX-pedition operation.

For FT DX 5000D and FT DX 5000 has included TCXO (Temperature-Compensated Crystal Oscillator) is rated at ± 0.5 ppm, over an ambient temperature range of $+14^{\circ}\text{F}$ to $+140^{\circ}\text{F}$ (-10°C to $+60^{\circ}\text{C}$).



OCXO (For FT DX 5000MP)

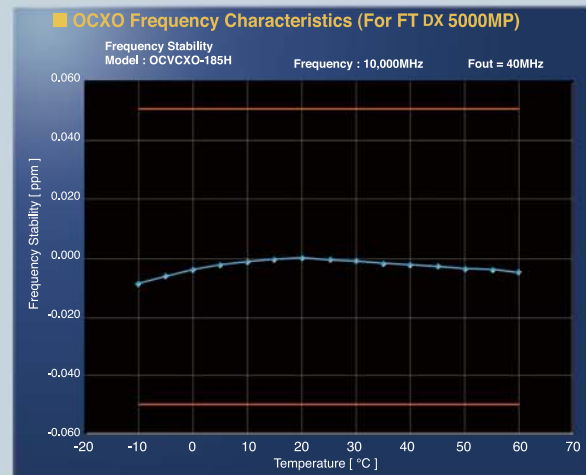

The New Premium HF/50 MHz Transceiver



SM-5000 Matching Station Monitor (with stereo speaker system) (Optional for FT DX 5000)

The SM-5000 matching station monitor is included with the FT DX 5000MP and FT DX 5000D models. A complete stereo speaker system with superb audio quality, will enhance your radio listening! The SM-5000 also displays the same Spectrum Scope with LBWS function as the DMU-2000. The responsive, high-resolution Spectrum Scope lets you watch activity on the band.



Versatile Station Control functions

● High-Resolution Spectrum Scope with LBWS

You can monitor activity on the VFO-A band. The RF Band Scope function allows you to view activity within a span of 25 kHz, 50 kHz, 100 kHz, 250 kHz, 500 kHz, 1 MHz, or 2.5 MHz. Choose CTR (center) or FIX (to limit lower and upper frequencies) modes, and control signal levels with ATT (attenuator) 0, -10, or -20 dB. Additionally, LBWS (Limited Band Width Sweep) function allows you to reduce the bandwidth in order to increase the sweep speed.

● High speed "LBWS" display

With a 50% bandwidth reduction at LBWS-1, you will get double the sweep speed. At LBWS-2 with reduction to 30% of the original sweep, you will get a 3x increase in sweep speed. And by reducing the bandwidth to 10% at LBWS-3, you will get a whopping 10x increase in the sweep speed.

You may move the LBWS display window (bandwidth) up or down the band, according to your preference.

● Versatile practical display modes for DX operation to monitor activity

You may display the signal AVERAGE (average), or the PEAKHOLD (peak-hold), or the NORMAL (normal/real-time activity), to monitor band activity as you prefer.

● TX RF Monitor Feature when transmitting

● High quality enhanced stereo speaker system may be configured to output VFO A and VFO B together from both speakers or separately on the right and left speakers.

● Brightness (Dimmer) and Contrast adjustment

Specifications:

Speakers : 65 mm (2.55 in) x 25 mm (0.98 in) x 2 sets
 Audio Output: 1.5 W+1.5 W (@ 8 Ω)
 Dimensions : 462 W mm (18.18 in) x 45 H mm (1.77 in) x 181 D mm (7.12 in)
 Weight : Approx. 2.5 kg (5.55 lbs)

The radio YAESU ...

FT DX 5000MP



HF/50 MHz 200 W Transceiver
FT DX 5000MP

Station Monitor SM-5000 included
 ±0.05 ppm OCXO included
 300 Hz Crystal Roofing Filter included
 600 Hz Crystal Roofing Filter included
 3 kHz Crystal Roofing Filter included

HF/50 MHz 200 W Transceiver
FT DX 5000D

Station Monitor SM-5000 included
 ±0.5 ppm TCXO included
 600 Hz Crystal Roofing Filter included
 3 kHz Crystal Roofing Filter included

HF/50 MHz 200 W Transceiver
FT DX 5000

Station Monitor SM-5000 optional
 ±0.5 ppm TCXO included
 600 Hz Crystal Roofing Filter included
 3 kHz Crystal Roofing Filter included

Supplied Accessories: Hand Microphone MH-31B8, Remote Control Keypad FH-2

Ultra-Clean Transmitter Design

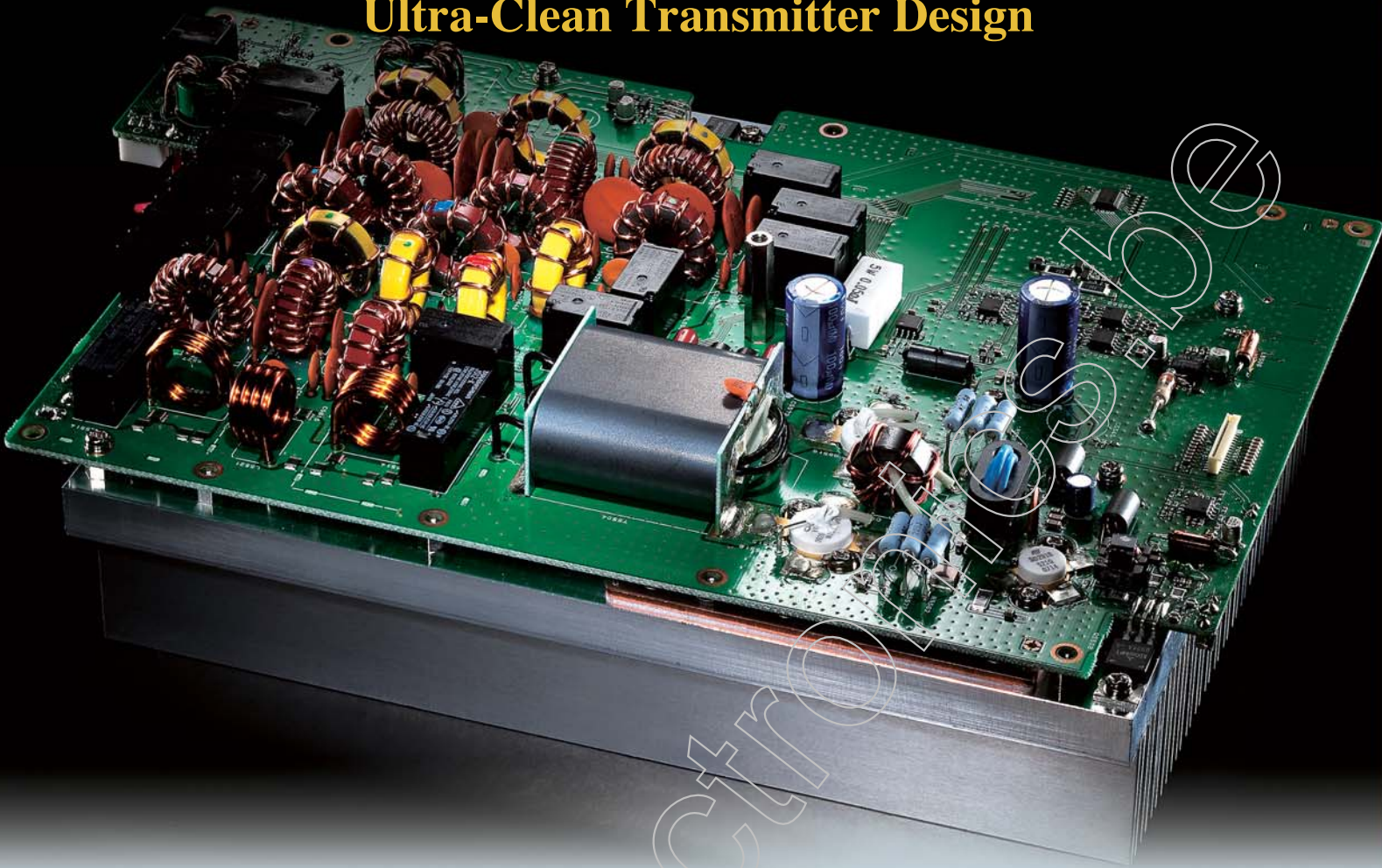

High-power, Super-stable Final Amplifier Stage (200 W, Class-A Mode – 75 W)

The FT DX 5000 Series utilize push-pull VRF150 MOS FET devices (VDSS=170 V, VGS=±40 V, PD=300 W), operating at 50 V, with user-adjustable bias control to ensure the optimum suppression of intermodulation distortion products.



A Huge Die-Cast Aluminum Heat Sink with a high coefficient cooling fan

The elaborate heat sink design includes a combination of aluminum and 3 mm thick high-conductivity copper plate, with a total heat sink capacity of 2720 cc, ensuring reliable long hours of 200-watt operation.

A thermostatically-controlled 3.6" (92 mm) axial cooling fan engages at +118 °F (+48 °C), and it features five speeds depending on the degree of cooling required. The large bearing surface of the fan (floating mount) and the unique heat sink design combine to make the cooling system absolutely super quiet, yet highly efficient.

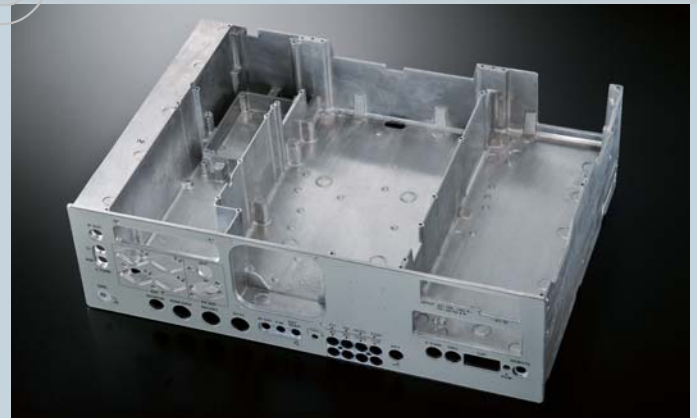

Aluminum Die-cast main frame

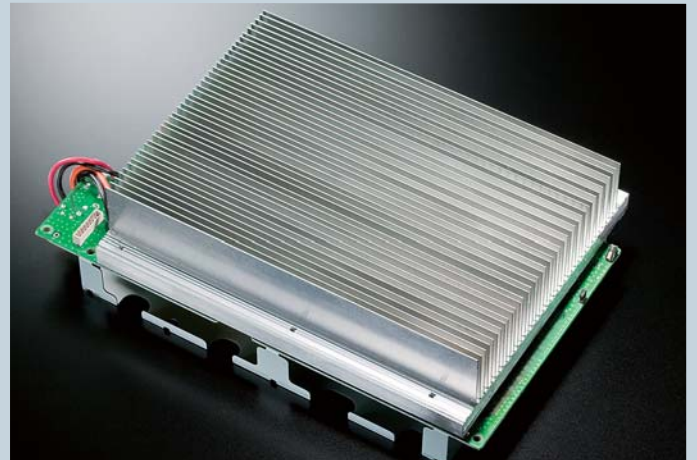

Oversized huge heat sink

Ultimate Low Distortion Class-A Final Amplifier

The FT DX 5000 includes provision for operation in a “Class-A” mode at 75 Watts output, utilizing high bias current to produce very low transmitter intermodulation products; the 5th and higher order IMD is typically suppressed 65 dB or better! Depending on ambient temperature or your operational duty cycle condition such as contest or DX-pedition, etc., you may adjust the bias level between Class A and AB.

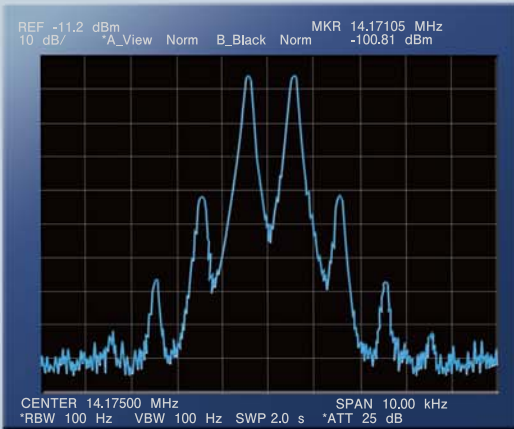

Class-A

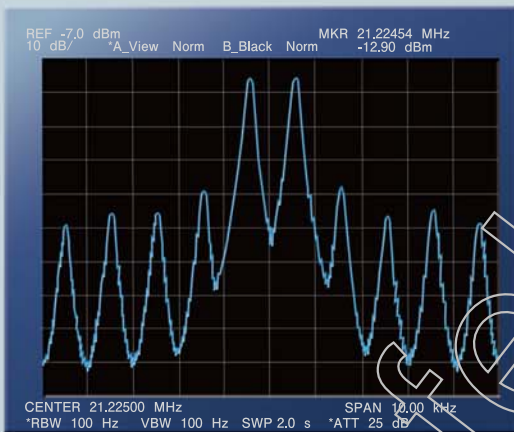

Class-AB

High Quality Digital SSB Modulation

The YAESU DSP digital modulation technique produces an analog-sounding high-quality digital SSB modulation envelope, and allows the transmission bandwidth to be adjusted by the operator.

Parametric Microphone Equalizer

Within each of the three (low, mid, and high frequency) audio bands provided, you may adjust the center frequency of the equalization, the band width over which the equalization is applied, and the amplitude within that range. Tailor the transmit audio to your personal preferences!

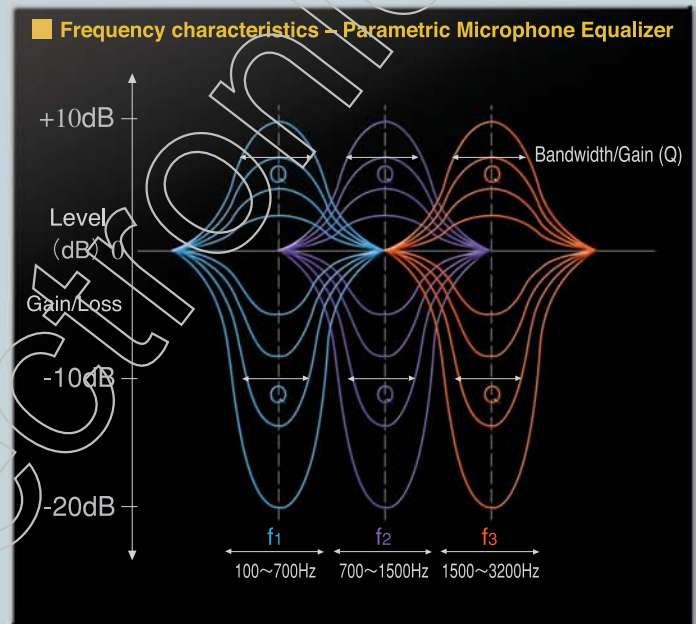

Renowned YAESU Speech Processor for that Contest or DX Pile-up Punch

The power of IF DSP is brought to the world of Speech Processing with the new, powerful, high quality DSP Speech Processor design incorporated into the FT DX 5000. The built-in Speech Processor is designed to optimize frequency response and increase intelligibility at the receiving side of a difficult path.

The compression level for the Speech processor can be adjusted from the front panel to obtain the best performance during your DX pile-up operation or when propagation conditions vary.

Transmit Monitor Feature

The IF Transmission Monitor allows you to listen to an accurate reproduction of the transmitter's IF signal for making precise adjustments to the Parametric Equalizer, SSB Bandwidth, and/or Speech Processor. The Monitor Level may be adjusted from the front panel.

High Speed Automatic Digital Antenna Tuner

The lighting-fast high speed automatic digital antenna tuner makes it possible for you to tune around the bands without the need to re-tune as you go, to ensure efficient operation.



Automatic Digital Antenna Tuner Unit

Great features for real CW enthusiasts...

CW Zero-in Feature

The sidetone generated when you transmit (as set by the CW Pitch on the front panel with a range of 300 – 1050 Hz, 10Hz step) allows you to match the sidetone pitch to the incoming signal perfectly (Select the CW Tuning Display in the MENU to activate this function). As you tune closer to the sidetone pitch, the CW Tuning Indicator provides a visual and graphical depiction of the tuning process, with a marker moving towards the center of the scale display (“CLAR” display on the front panel) when the incoming CW signal is precisely aligned with yours.

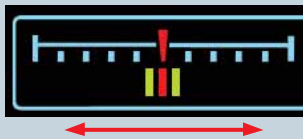

CW Spot Feature

The CW SPOT switch engages a spotting tone that matches the offset of your transmitted signal (as set by the CW Pitch selection), allowing you to match the pitch of an incoming CW signal perfectly. There is no more reliable method to be sure you are exactly on the “SPOT”!

Additional CW Capabilities

- DSP APF (Audio Peak Filter) function
- 
- Separate KEY jacks on the front and rear panels
 - Built-in Electronic Keyer with 4-60 WPM speed control
 - Electronic Keyer Weight control
 - Keyer paddle Dot-Dash reversal
 - “Bug” keying emulation
 - CW Full Break-in
 - Message Memory function with FH-2 Keypad: 5 ch x 50 characters
 - Automatic insertion of incrementing contest numbers into stored messages
 - Automatic “Beacon” keyer mode
 - Adjustable CW VOX Delay: 20 msec – 5000 msec
 - CW Mode Reversal (USB or LSB injection)
 - CW keying available during SSB operation

Leading-edge Features for the Serious Operator

Block Diagram Display

The unique “Block Diagram Display” shows the current status of a number of functions in the receiver of your radio. At a glance, you will see the settings from a number of critical functions of the radio, including current antenna, IPO operation status, selected filter, etc.

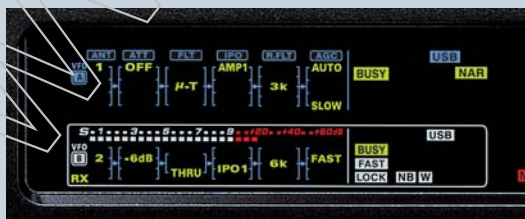

“My Bands” Feature

In order to increase operating efficiency, you may use the MENU system, to command the Radio to “skip” over any Amateur Radio bands which you do not operate so frequently. For example, if you do not need the 10/18/24 MHz bands for your contest operation, you may eliminate them from the band stepping sequence for your convenience.

CS Key

The CS (Custom Selection) key, located just below and to the left of the Main Tuning Dial, lets you select any MENU item for one-touch access via the CS key. This lets you bring up a favorite MENU item without having to scroll through the many available MENU selections. When the SM-5000 Station Monitor is connected, this CS key works to recall its set up Menu items.

- High-accuracy Analog Meter
- Band Stack Operation to store up to three favorite frequencies and modes into each band’s VFO register.
- Quick Split-frequency Operation
- TXW (TX Frequency Watch) to monitor the transmit frequency when split frequency operation is engaged
- VFO Tracking Feature (the Sub VFO-B can track the frequency changes of the Main VFO-A, maintaining a constant split between the two frequencies)
- Sloped AGC system that allows audio volume to rise/fall according to signal strength
- QMB (Quick Memory Bank) for instant storage and recall of frequency/mode information.
- Digital Voice Recorder function, a running 15-second loop recorder, to let you stop and play back the just-received audio! You can re-confirm a call sign or message you just received!
- 5 channel digital message memory function for repetitive voice messages (storing up to 20 sec. with FH-2).
- The FH-2 Keypad provides message storage and recall of voice and CW messages together with remote control functions.
- VOX (Voice-operated TX/RX control: SSB/AM/FM modes)
- MOX (Manual TX/RX control)
- All-mode Squelch function
- 50-tone CTCSS Encoder/Decoder for FM operation
- Repeater Shift function when operating 29 MHz FM.
- Wide/Narrow modes for AM and FM
- Independent VFO lock for VFO-A and VFO-B
- Flexible, easy-to-use VFO/Memory command selections: VFO-A → VFO-B, VFO-A ← → VFO-B, VFO/Memory, Memory → VFO-A, VFO-A → Memory
- Memory Channel Offset Tuning function (MT)
- Versatile Scanning capability
- Versatile Menu Mode for customization of setup and features
- Constant-level rear-panel (transmit and receive) audio sound recording jack
- Comprehensive external RS-232C computer control (CAT) protocol
- Rotator Control function to control the speed and direction of a YAESU G-800DXA, G-1000DXA, or G-2800DXA rotator using the 10 key keypad
- Various easy connections provided for RTTY, SSTV, PSK31, JT65 (EME) and other digital modes
- Optional VL-1000 Quadra System (HF-50MHz Linear Amplifier) for automatic 1 kW operation!
- General coverage reception: 30 kHz – 60 MHz (NB: Specifications guaranteed only in Amateur Radio bands)
- Mode-optimized Automatic AGC decay selection (OFF/SLOW/MID/FAST)
- Versatile Memory system: 99 channels and up to 5 Memory Groups
- Transverter Output Port: Low level transverter output port (about 0.1 mW – 14 MHz, 28 MHz, or 50 MHz)
- Preset “NARROW” switch
- IF Noise Blanker



Optional parts and accessories to customize your FT DX 5000



Optional Fully-automatic External μ -tuning with 1.1" (28 mm) Coil

On the lower Amateur Radio Bands, high signal voltages impinging on a receiver can create noise and intermodulation effects that may cover up weak signals you are trying to pull through.

Now, three optional tuning modules (MTU-160, MTU-80/40, and MTU-30/20) are available to cover all the Amateur Radio bands from 160-meters to the 20-meter band!

The RF μ -Tuning filters utilize a stack of large 1.1" (28 mm) Ni-Zn Ferrite cores, driven through a silver-plated coil assembly by a precision stepper motor. The resulting high Q (typically over 300) provides a very steep resonance peak near your operating frequency. (On the 160 m band, typically -3 dB@ \pm 12 kHz, -30 dB@ \pm 450 kHz.)

The RF μ -Tune system turns off when leaving the frequency or QSYing to other bands. The RF μ -Tune system will be re-engaged and automatically adjusts to your current operating frequency when you operate on a band that is tuned by the optional RF μ -Tune Unit.

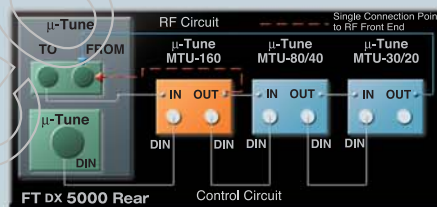

RF μ -Tune unit Connection Diagram

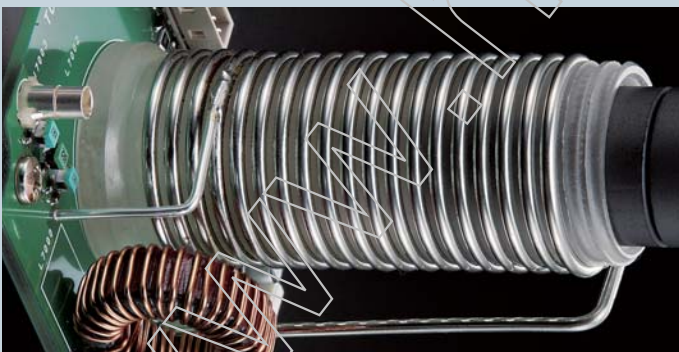
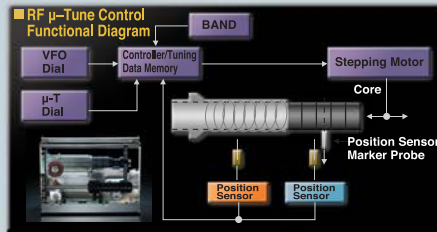

1.1" (28mm) Coil (Actual size)



High-durability Synchro Belt Drive and HB Stepper Motor



Inside the RF μ -Tune unit

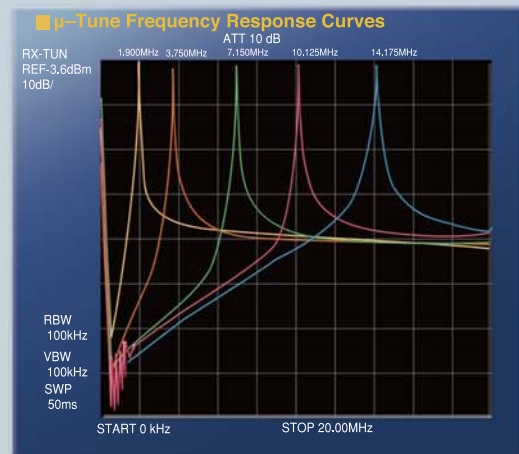

The Optional DMU-2000 External Data Management Unit will enhance your DX operation!

The same operating and station information, available with the FT DX 9000 Series, can be conveniently displayed by adding the optional DMU-2000 Data Management Unit and an after-market PC display (Analog screen resolution: 800 x 600/SVGA, 1024 x 768/XGA standard).



*PC Monitor Display, Keyboard and Key Paddle are after-market items and not supplied with the FTDX500/DMU-2000

Data Management Unit DMU-2000 (Option)



DMU-2000



DMU-2000 - Inside

Spectrum Scope with LBWS

The RF Band Scope allows you to view activity within a span of 25 kHz, 50 kHz, 100 kHz, 250 kHz, 500 kHz, 1 MHz, or 2.5 MHz, depending on your requirements, with a fixed sweep speed for seamless transition between spans. Additionally the Yaesu exclusive LBWS (Limited Band Width Sweep) allows reduction of the bandwidth to 50%, 30%, or 10% of the original, producing a corresponding increase in the sweep speed. Sweeping just a limited portion of the main Band Scope at high speed, will produce a superbly detailed view of activity in that segment of the overall band, allowing precise zero-in capability not found with competing products! With a 50 % bandwidth reduction, you will get double the speed; with reduction to 30 % of the original sweep, you will get a 3X increase in speed; and by reducing the bandwidth to 10 %, you will get a whopping 10X increase in the sweep speed. You can use the “←” and “→” keys to move the remaining window, as desired. Choose the Spectrum Scope Function (which will plot the operating frequency in the middle of the monitor screen) or the Band Monitor Function (which will display the current operating band). With the Band Monitor Function, the preferred lower starting frequency may be set for the CW or SSB operation. Once it is set up, the lowest starting frequency will not change, even when the bandwidth is reset.



•SPAN 2500 kHz



•LBWS Display SPAN 50 kHz (LBWS-2)

Audio Scope/Oscilloscope Display Function

The Audio Scope Function portrays the audio spectrum either of the receiver passband or of the transmitted signal. The adjustments of the RX Notch Filter, Contour Control, and the TX Parametric Microphone Equalizer are clearly visualized on the monitor screen.

Also, use the Oscilloscope, with variable level and sweep speed, to observe the X-Y characteristics of an incoming signal, check CW tone pitch, etc.



•Spectrum Scope Display



•Waterfall Display

Swept-Frequency SWR Display

As you tune across the Amateur Radio band and transmit at different frequencies, the DMU-2000 will plot the SWR across the band, alerting you to any unusual SWR situations, etc.



Memory Channel List

Easily edit and confirm memory frequencies and channels on your bigger and wider monitor screen! You can add alpha-numeric “Tags” to each memory for quick recall of the channel’s identification.



World Clock Display

The World Clock Function includes a world map, with entries for a number of locations throughout the world. You will see the time of day at the contact’s location, or anywhere in the world.

An alarm feature is also included to alert of a planned operation or a DX station’s scheduled time!



Rotator Control Function

Aim your directional antenna accurately! The Rotator Control function lets you control the left/right rotation of your Yaesu G-800/1000/2800DXA. The DMU-2000 includes a Great Circle Map that allows you to aim your directional antenna accurately. For example, Tokyo looks as if it is located “West” of San Francisco; however the correct antenna heading is located to the NNW direction. The imbedded database of worldwide cities may be used to determine a specific bearing to a DX location.

You may also connect a GPS Unit (capable of NMEA0813 position data out put) to the FT DX 5000/DMU-2000, to download your precise position data.



•Rotator Control Feature



•Antenna Bearing Indication using Great Circle Map

Log Book Feature

By connecting an after-market keyboard and monitor to the DMU-2000, you can utilize the on-board logging capability of the FT DX 5000! You may also archive your logbook data to a CF card and edit the log data using one of the available popular logging formats.



Rear Panel

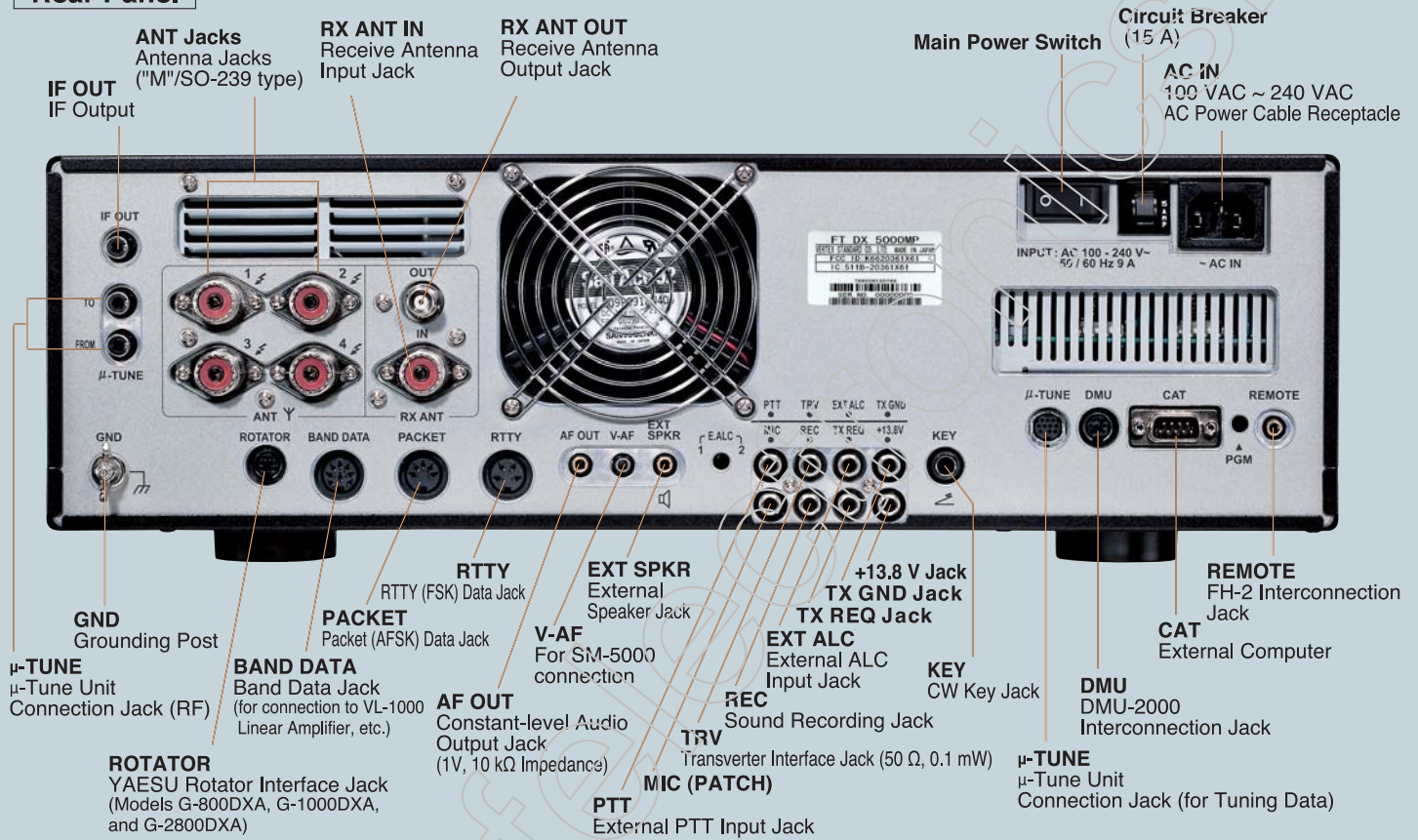

Top View

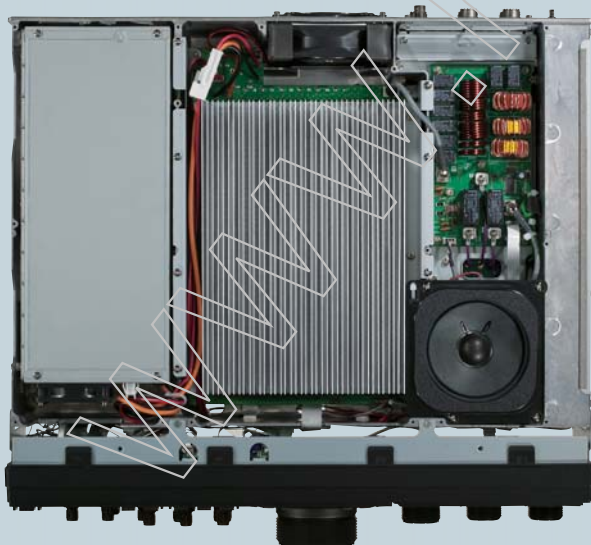

Bottom View

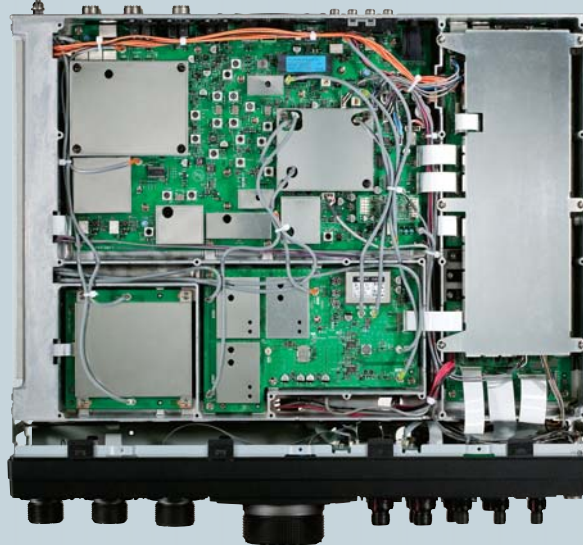

Side View



SPECIFICATIONS

| GENERAL | |
|--------------------------------|--|
| RX Frequency Range | 30 kHz - 60 MHz (operating)* 1.8 - 29.7 MHz, 50 - 54 MHz (specified performance, Amateur bands only)* |
| TX Frequency Ranges | 1.8 - 29.7 MHz, 50 - 54 MHz (Amateur bands only) 5.16750MHz, 5.33200MHz, 5.34800MHz, 5.36800MHz, 5.37300MHz, 5.40500MHz (USA version only) |
| Frequency Stability | ±0.05 ppm (MP version, after 1 minute @+14 °F ~ +140 °F [-10 °C ~ +60 °C]) ±0.5 ppm (after 1 minute @+14 °F ~ +140 °F [-10 °C ~ +60 °C]) |
| Operating Temperature Range | +14 °F ~ +140 °F (-10 °C ~ +60 °C) |
| Emission Modes | A1A (CW), A3E (AM), J3E (LSB, USB), F3E (FM), F1B (RTTY), F1D (PACKET), F2D (PACKET) |
| Frequency Steps | 1/5/10 Hz (SSB,CW, & AM), 100 Hz (FM) |
| Antenna Impedance | 50 Ohms, unbalanced 16.7 - 150 Ohms, unbalanced (Tuner ON, 1.8 - 29.7 MHz Amateur bands) 25 - 100 Ohms, unbalanced (Tuner ON, 50 MHz Amateur band) |
| Power Consumption (@117 VAC) | Rx (no signal) 70 VA Rx (signal present) 80 VA Tx (200 W) 720 VA |
| Supply Voltage | AC 90 V - AC 264 V |
| Dimensions (WxHxD) | 18.2" x 5.3" x 15.3" (462 x 135 x 389 mm) w/o knob and connector |
| Weight (approx.) | 46.3 lbs (21 kg) |
| TRANSMITTER | |
| Power Output | 10 - 200 watts (CW, LSB, USB, FM, RTTY, PKT) 5 - 50 watts (AM carrier) 10 - 75 watts (Class A: LSB, USB) |
| Modulation Types | J3E (SSB): Balanced, A3E (AM): Low-Level (Early Stage) F3E (FM): Variable Reactance |
| Maximum FM Deviation | ±5.0 kHz / ±2.5 kHz |
| Harmonic Radiation | Better than -60 dB (1.8 - 50 MHz Amateur bands) |
| SSB Carrier Suppression | At least 60 dB below peak output |
| Undesired Sideband Suppression | At least 60 dB below peak output |
| Audio Response (SSB) | Not more than -6 dB from 300 to 2700 Hz |
| 3rd-order IMD | -31 dB @14 MHz, 200 watts PEP -40 dB @14 MHz, Class A: 75 watts PEP |
| Bandwidth | 500 Hz (CW) 3.0 kHz (LSB, USB) 6.0 kHz (AM) 16 kHz (FM) |
| Microphone Impedance | 600 Ohms (200 to 10 k Ohms) |

| RECEIVER | | | |
|----------------------------|---|-------------------|-----------------|
| Circuit Type | VFO-A; Double-conversion superheterodyne VFO-B; Triple-conversion superheterodyne | | |
| Intermediate Frequencies | VFO-A; 9 MHz /30 kHz (24 kHz for AM/FM) VFO-B; 40.455 MHz/455 kHz /30 kHz (24 kHz for AM/FM) | | |
| Sensitivity | SSB (2.4 kHz, 10 dB S+N/N) 2 μV (0.5 - 1.8 MHz, IPO1) 0.2 μV (1.8 - 30 MHz, AMP2)* 0.125 μV (50 - 54 MHz, AMP2) AM (6 kHz, 10 dB S+N/N, 30% modulation @400 Hz) 6 μV (0.5 - 1.8 MHz, IPO1) 2 μV (1.8 - 30 MHz, AMP2)* 1 μV (50 - 54 MHz, AMP2) FM (BW: 15 kHz, 12 dB SINAD) 0.5 μV (28 - 30 MHz, AMP2) 0.35 μV (50 - 54 MHz, AMP2) There is no specification in frequency ranges not listed. | | |
| Squelch Sensitivity (AMP2) | SSB/CW/AM 2 μV (0.5 - 30 MHz) 2 μV (50 - 54 MHz) FM 1 μV (28 - 30 MHz) 1 μV (50 - 54 MHz) There is no specification in frequency ranges not listed. | | |
| Selectivity (-6/-60 dB) | Mode | -6 dB | -60 dB |
| | CW | 0.5 kHz or better | 750 Hz or less |
| | LSB, USB | 2.4 kHz or better | 3.6 kHz or less |
| | AM | 6 kHz or better | 15 kHz or less |
| | FM | 12 kHz or better | 30 kHz or less |
| Image Rejection | 70 dB or better (1.8 - 29.7 MHz Amateur bands, VRF: ON) 60 dB or better (50 MHz Amateur band) | | |
| Maximum Audio Output | 2.5 W into 4 Ohms with 10% THD | | |
| Audio Output Impedance | 4 to 8 Ohms (4 Ohms: nominal) | | |
| Conducted Radiation | Less than 4000 μW | | |

*Except the 9 MHz.

Specifications are subject to change, in the interest of technical improvement, without notice or obligation, and are guaranteed only within the amateur bands.

Note: Modification for the 135 kHz Band Operation

The output power will be about 10 mW (+10 dBm) from the Transverter Output Port. Please contact your local Vertex Standard business office for further information

OPTIONS

| | | | |
|---|--|--|--|
|  SM-5000 Station Monitor (It is included with FT dx 5000MP and FT dx 5000D) |  XF-126CN CW Narrow Crystal Filter (C/F: 9 MHz, B/W: 300 Hz) (It is installed with FT DX 5000MP) |  QUADRA SYSTEM HF-50 MHz 1 kW Linear Amplifier (50 MHz: 500 W/USA Version) VL-1000 Automatic Antenna Tuner Built In |  VL-1000 Power Supply VP-1000 External Speaker with Audio filters |
|  MD-200A8X Ultra High fidelity Desktop Microphone |  YH-77STA Lightweight Stereo Headphone | RF μ-tune Kits | |
| | |  RF μ-Tune Kits A For 160 m Band |  RF μ-Tune Kits B For 80/40 m Bands |
| | |  RF μ-Tune Kits C For 30/20 m Bands | T9101556 Antenna Rotator Connection Cable |

· Up to three μ-Tune Kits may be connected. · μ-Tune Kit is included in purchase price of μ-Tune Unit.

About this brochure: we have made this brochure as comprehensive and factual as possible. We reserve the right, however, to make changes at any time in equipment, optional accessories, specifications, model numbers, and availability. Precise frequency range may be different in some countries. Some accessories shown herein may not be available in some countries. Some information may have been updated since the time of printing; please check with your Authorized Yaesu Dealer for complete details.

YAESU
 Amateur Radio Division of Vertex Standard

VERTEX STANDARD CO., LTD. <http://www.vxstd.com>
 4-8-8 Nakameguro, Meguro-ku, Tokyo 153-8644, Japan

VERTEX STANDARD USA <http://www.vertexstandard.com>
US Headquarters 10900 Walker Street, Cypress, CA 90630, U.S.A.

YAESU UK LTD. <http://www.yaesu.co.uk>
 Unit 12, Sun Valley Business Park, Winnall Close
 Winchester, Hampshire, SO23 0LB, U.K.

VERTEX STANDARD HK LTD. <http://www.vxstd.com.hk>
 Unit 5, 20/F., Seaview Centre, 139-141 Hoi Bun Road,
 Kwun Tong, Kowloon, Hong Kong

VERTEX STANDARD AUSTRALIA PTY., LTD. <http://www.vxstd.com.au>
 Normanby Business Park, Unit 14/45 Normanby Road
 Notting Hill 3168, Victoria, Australia

