



CHART PLOTTER NAME	DESCRIPTION	SOFTWARE
SW501e	5" Sunlight Readable Vertical Color Display External Smart GPS Receiver	S4x2SW5vc
SW501i	5" Sunlight Readable Vertical Color Display Internal GPS Receiver	S4x2SW5vc
SW501ce	5" Sunlight Readable Vertical Color Display External Smart GPS Receiver & Internal FF	S4x2SW5vc
SW501ci	5" Sunlight Readable Vertical Color Display Internal GPS Receiver & Internal FF	S4x2SW5vc
SW701e	7" Sunlight Readable WVGA Color Display External Smart GPS Receiver & Video Input	S4x2SW8wc
SW701i	7" Sunlight Readable WVGA Color Display Internal GPS Receiver & Video Input	S4x2SW8wc
SW701ce	7" Sunlight Readable WVGA Color Display External Smart GPS Receiver & Video Input & Internal FF	S4x2SW8wc
SW701ci	7" Sunlight Readable WVGA Color Display Internal GPS Receiver & Video Input & Internal FF	S4x2SW8wc
SW1101	11" Sunlight Readable Color Display External Smart GPS Receiver & Video Input	S5e2SW11c
SEAWAVE <sup>3</sup>	12" Color Display External Smart GPS Receiver & Video Input	S5egSW12c
MARLIN	15" Color Display External Smart GPS Receiver & Video Input	S5egSW15c
EXPLORER <sup>3</sup>	Controller for Color Display External Smart GPS Receiver	S5egSWctcj

Copyright 2011 Seiwa - Hong Kong

All rights reserved. No part of this publication may be reproduced or distributed in any form or by any means, or stored in a database or retrieval system, without prior written permission of the publisher.

# User Manual

code: (C1622-080311e)

# Important Information

---

## WARNING

Electronic charts displayed by the chart plotter are believed to be accurate and reliable, but they are not intended to replace official charts which should remain your main reference for all the matters related to the execution of a safe navigation. For this reason we would like to remind you that you are required to carry on board and use the officially published and approved nautical charts.

## CAUTION

- Please read through this manual before the first operation. If you have any questions, please contact the Company's customer service or your local dealer.
- The chart plotter is not built water proof. Please give attention to avoid water intrusion into the chart plotter. Water damage is not covered by the warranty.
- Extensive exposure to heat may result in damage to the chart plotter.
- Connection to the power source with reversed polarity will damage the chart plotter severely. This damage is not covered by the warranty.
- The chart plotter contains dangerous high voltage circuits which only experienced technicians MUST handle.
- The C-MAP By JEPPESEN DATA MEDIA are available from your local dealer.
- Exposure of the display to UV rays may shorten the life of the liquid crystals used in your plotter. This limitation is due to the current technology of the LCD displays.
- Avoid overheating which may cause loss of contrast and, in extreme cases, a darkening of the screen. Problems which occur from overheating are reversible when temperature decreases.

### WARNING ON SERIAL PORTS CONNECTION

*Please be aware that the serial ports are not opto-isolated and then the external device is electrically connected to the chart plotter. This allows the connection of high speed devices, like Radar or Fish Finder. If you are connecting a NMEA0183 device and you would like to isolate it from the chart plotter, you have to add the opto-isolator externally.*

## CLEANING PROCEDURE FOR THE PLOTTER SCREEN

Cleaning your chart plotter screen is a very important operation and must be done carefully, as the window's surface is covered with an antireflective coating. The following is the cleaning procedure: you use a tissue or lens tissue and a cleaning spray containing Isopropanol (a normal spray cleaner sold for the PC screen, for example PolaClear by Polaroid). Fold the tissue or lens tissue into a triangular shape, moisten the tip and use the index finger behind a corner to move the tissue across the surface, in overlapping side to side strokes. If the tissue is too wet, a noticeable wet film will be left in its path and you will need to repeat the process. If too dry, the tissue won't glide easily, and may damage the surface.

**NOTE** *We will not be liable for errors contained herein, or for incidental or consequential damages in connection with the performance or use of this material.*

# Contents

---

<b>Important Information</b> .....	<b>4</b>
WARNING .....	4
CAUTION .....	4
CLEANING PROCEDURE FOR THE PLOTTER SCREEN .....	4
<b>About this User Manual</b> .....	<b>13</b>
INTRODUCTION .....	13
CONVENTIONS USED .....	13
MANUAL LAYOUT .....	13
IF YOU NEED ASSISTANCE .....	14
<b>1. Getting Started</b> .....	<b>15</b>
1.1 THE KEYBOARD .....	15
1.1.1 Keys For SW501e/i/c/ci, SW701e/i/c/ci and SW1101 .....	15
Cursor key .....	15
Dedicated Keys .....	15
1.1.2 Keys For MARLIN .....	16
Cursor key .....	16
1.1.3 Keys For EXLORER <sup>3</sup> .....	17
Cursor key (Joystick) .....	17
1.1.4 Keys For SEAWAVE <sup>3</sup> .....	17
Cursor key (Joystick) .....	17
1.1.5 Software Keys .....	18
1.1.6 Function Keys .....	19
1.1.7 Software/Function Keys Customization .....	19
1.1.8 Alphanumeric Input Procedure .....	20
1.2 SWITCHING ON/OFF .....	21
Switching On .....	21
Switching Off .....	21
1.3 FIRST SETUP PAGE .....	21
1.4 CHANGING BACKLIGHT AND CONTRAST .....	22
1.5 SELECTING THE LANGUAGE .....	23
1.6 SELECTING THE CHART LANGUAGE .....	23
1.7 C-MAP By JEPPESEN MAX CARTOGRAPHY INFORMATION .....	23
Data Features .....	23
Presentation Features .....	24
Cartographic Data related Features .....	24
1.8 USING C-MAP By JEPPESEN DATA MEDIA .....	25
1.9 SIMULATION MODE .....	25
1.10 CONTROLLING THE DISPLAY .....	25
Changing Display Mode .....	25
Moving around the Chart and Changing Chart Scale .....	28
Finding Your Boat Position .....	28
Selecting Screen Amplifier .....	28
Selecting Map Orientation .....	28
1.11 NAVIGATION TO A SINGLE DESTINATION .....	29
1.12 A-B FUNCTION .....	29
Inserting A-B .....	29
Deleting A-B .....	29
1.13 RANGE/BEARING FUNCTION .....	29
Inserting R/B .....	29

Deleting R/B .....	29
Editing R/B .....	30
1.14 MAN OVERBOARD (MOB) .....	30
Inserting MOB .....	30
Selecting Auto Info on MOB .....	30
Deleting MOB .....	30
<b>2. Operations .....</b>	<b>31</b>
2.1 USER POINTS: MARKS, EVENTS AND WAYPOINTS .....	31
Creating Waypoint .....	31
Creating Mark .....	31
Creating Event .....	31
Editing User Point .....	31
Deleting User Point .....	31
Moving User Point .....	32
Locating User Point on Map .....	32
Sending/Receiving User Point .....	32
Selecting User Points List page .....	32
2.2 ROUTES .....	33
Selecting Active Route .....	33
Creating a Route .....	33
Inserting notes on Route .....	33
Hiding or Showing Route .....	34
Selecting Route Color .....	34
Deleting Route .....	34
Following a Route (Activate the Navigation) .....	34
Inserting Waypoint .....	35
Reversing Route .....	35
Selecting Route Report page .....	35
Sending Route .....	35
Receiving Route .....	35
Safe Route Checking .....	35
2.3 GOTO FUNCTION .....	37
Navigation to Waypoint .....	37
Deleting destination .....	37
2.4 USING TRACK .....	37
Setting up a Track Step .....	37
Selecting Track Color .....	38
Displaying Track .....	38
Activating/Deactivating Track Recording .....	38
Clearing Track .....	39
Selecting Track Number .....	39
TRACK TO ROUTE FUNCTION .....	39
Track To Route .....	39
Select Track Number .....	39
Select Route Number .....	40
2.5 DATA WINDOW CUSTOMIZATION ON CHART PAGE .....	40
2.6 INFO .....	40
Setting Automatic Info .....	40
Selecting Automatic Info .....	40
Displaying Expanded Info page (Full Info) .....	40
Info on objects with Pictures .....	40
Info Tree and Expanded Info page .....	42
Quick Info on Lakes .....	42
Full Info on Lakes .....	42
2.7 PORT & TIDE INFO .....	43
Getting Port Info .....	43
Getting Tide Info .....	44
2.8 FIND FUNCTION .....	45
Finding Nearest Port Services .....	45

Finding Nearest Port By Name .....	45
Finding Nearest Port By Distance .....	45
Finding Nearest Tide Station .....	45
Finding Nearest Wrecks .....	45
Finding Nearest Obstructions .....	46
Finding Nearest Lakes Information .....	46
Finding Nearest Lakes By Name .....	46
Finding Nearest Points Of Interest .....	46
Finding Cursor .....	46
Finding Coordinates .....	46
Finding User Points .....	46
2.9 ALARMS .....	47
Auto Off .....	47
Arrival Alarm .....	47
XTE Alarm .....	47
Anchor Alarm .....	47
Depth Alarm .....	47
HDOP Alarm .....	47
Heading Alarm .....	47
Timer Alarm .....	48
Timer Direction .....	48
Grounding Alarm .....	48
Grounding Alarm Range .....	48
Grounding Alarm Report .....	48
External Alarm .....	49
2.10 USER MEDIA: Save & Load Menu .....	49
USER MEDIA page .....	49
Formatting USER MEDIA .....	49
Saving File on USER MEDIA .....	49
Loading File from USER MEDIA .....	50
Deleting File from USER MEDIA .....	50
Selecting Slot .....	50
Reading USER MEDIA directory .....	50
Sorting USER MEDIA directory .....	51
<b>3. User Setting Up .....</b>	<b>53</b>
3.1 GENERAL OPTIONS MENU .....	53
3.2 MAP OPTIONS MENU .....	53
Zoom Type .....	53
Fonts & Symbols .....	53
Perspective View .....	54
Dynamic Nav-Aids .....	54
Map Orientation .....	54
Mixing Levels .....	55
Safety Status Bar (DSI = Data Safety Indicator) .....	55
Palette .....	56
Satellite Imagery .....	56
Currents Prediction .....	56
3.3 OTHER MAP CONFIGURATIONS .....	57
Display Mode .....	57
Marine Settings .....	57
Depth Settings .....	58
Land Settings .....	58
Chart Settings .....	58
Underwater Objects Settings .....	58
3.4 DISPLAY OPTIONS MENU .....	59
3.5 VIDEO MODE .....	60
3.5.1 Add Video menu .....	60
3.5.2 Video Input menu .....	60
3.6 ADVANCED OPTIONS MENU .....	61

3.6.1	Input/Output menu .....	61
	GPS Connection .....	61
	GPS Setup Menu .....	61
	Fish Finder Transmission .....	61
	Autopilot Connection .....	61
	External NMEA Connection .....	61
	C-COM GSM Plus Connection .....	62
	Output Sentences .....	62
	NMEA-0183 Output Talker ID .....	62
	External Signal .....	62
	Cable Wiring pages .....	63
	Send/Receive Routes & Marks .....	63
3.6.2	C-Link menu .....	63
3.6.3	Fix & Compass menu .....	63
3.7	AIS .....	64
3.7.1	AIS System Definitions .....	64
3.7.2	To set the chart plotter for receiving AIS .....	65
3.7.3	AIS Menu .....	65
3.7.4	Quick Info on AIS Target .....	66
3.8	C-WEATHER SERVICE .....	66
3.8.1	C-WEATHER SERVICE Menu .....	67
	Copy from USER MEDIA .....	67
	Download .....	67
	Forecast .....	67
	Real Time View .....	68
	Type of Data .....	68
3.9	DSC .....	68
3.9.1	Distress Call and Position Request .....	69
3.9.2	DSC Log page .....	69
3.9.3	DSC Directory page .....	70
3.9.4	Quick Info on DSC Icons .....	70
3.10	FISH FINDER .....	71
3.11	RADAR .....	71
3.12	SYSTEM INFORMATION .....	71
<b>4.</b>	<b>C-Link .....</b>	<b>73</b>
4.1	C-LINK SERIAL CONNECTION .....	73
4.2	C-LINK NAVIGATION DATA TRANSFER .....	73
4.3	OPERATIONS .....	73
	Introductive Elements .....	73
	Master Chart Plotter .....	74
	Slave Chart Plotter .....	74
	C-Link Navigation Data: Acquisition and Display .....	75
	Graphical Representation on Map Display .....	75
	Route Data Report .....	75
4.4	QUICK INFO .....	77
	Route Navigation: Quick Info on the Destination .....	77
	Quick info on Single Destination .....	77
<b>5.</b>	<b>Fish Finder SW501ce/SW501ci/SW701ce/SW701ci .....</b>	<b>79</b>
5.1	SETTING THE INTERNAL FISH FINDER ON .....	79
5.2	UNDERSTANDING THE FISH FINDER PAGE .....	79
5.2.1	Understanding the Echogram display .....	81
5.3	DISPLAYING THE FISH FINDER PAGE .....	82
5.3.1	How to select the Fish Finder page .....	82
	Selection by Soft Key .....	82
5.3.2	Fish Finder Full page .....	83
5.3.3	Dual Frequency page .....	84
5.3.4	Zoom page .....	84
5.3.5	Chart/Fish page .....	85

5.3.6	Fish Finder and Radar pages .....	85
5.4	ZOOM MODES .....	86
5.4.1	The Bottom Lock Zoom .....	86
5.4.2	The Marker Zoom .....	86
5.5	SOUNDER ADJUSTMENTS WITH SOFT KEYS .....	87
5.6	FISH FINDER SETUP MENU .....	87
5.6.1	Preset Mode .....	88
5.6.2	Gain Mode .....	88
5.6.3	Range Mode .....	88
5.6.4	Depth .....	88
5.6.5	Shift .....	88
5.6.6	Bottom Range .....	88
5.6.7	Frequency .....	88
5.6.8	Interference Rejection .....	88
5.6.9	Sensitivity Menu .....	89
5.6.10	Display Setup Menu .....	89
5.6.11	Transducer Setup Menu .....	89
5.6.12	Alarms Menu .....	90
5.6.13	Save & Load Menu .....	90
5.7	TRANSDUCERS .....	90
<b>6.</b>	<b>GPS .....</b>	<b>91</b>
6.1	HOW GPS WORKS .....	91
6.1.1	Position Fixing Accuracy: HDOP .....	92
<b>7.</b>	<b>Maintenance .....</b>	<b>93</b>
7.1	SYSTEM TEST .....	93
7.1.1	RAM Menu .....	93
7.1.2	DIM Menu .....	93
7.1.3	Media .....	93
7.1.4	Modem test .....	93
7.1.5	Serial Ports .....	94
7.1.6	External Alarm .....	94
	<b>Terms .....</b>	<b>95</b>
<b>SW501e/SW501i .....</b>		<b>101</b>
FEATURES & FUNCTIONS .....		101
TECHNICAL SPECIFICATIONS .....		102
INSERTING/REMOVING PROCEDURE .....		102
Inserting the MEDIA .....		102
Removing the MEDIA .....		103
CHART PLOTTER DIMENSIONS .....		103
INSTALLATION AND REMOVING .....		103
EXTERNAL WIRING .....		104
TYPICAL CONNECTIONS .....		104
C-COM Connection .....		105
<b>SW501ce/SW501ci .....</b>		<b>107</b>
FEATURES & FUNCTIONS .....		107
TECHNICAL SPECIFICATIONS .....		108
FF MODULE 600W-50-200KHz TECHNICAL SPECIFICATIONS .....		108
INSERTING/REMOVING PROCEDURE .....		109
Inserting the MEDIA .....		109
Removing the MEDIA .....		109
CHART PLOTTER DIMENSIONS .....		109
INSTALLATION AND REMOVING .....		109
EXTERNAL WIRING .....		110
TYPICAL CONNECTIONS .....		110
C-COM Connection .....		111

<b>SW701e/SW701i</b>	<b>113</b>
FEATURES & FUNCTIONS	113
TECHNICAL SPECIFICATIONS	114
INSERTING/REMOVING PROCEDURE	114
Inserting the MEDIA	114
Removing the MEDIA	115
CHART PLOTTER DIMENSIONS	115
INSTALLATION AND REMOVING	115
EXTERNAL WIRING	116
TYPICAL CONNECTIONS	117
C-COM Connection	118
<b>SW701ce/SW701ci</b>	<b>119</b>
FEATURES & FUNCTIONS	119
TECHNICAL SPECIFICATIONS	120
FF MODULE 600W-50-200KHz TECHNICAL SPECIFICATIONS	120
INSERTING/REMOVING PROCEDURE	121
Inserting the MEDIA	121
Removing the MEDIA	121
CHART PLOTTER DIMENSIONS	121
INSTALLATION AND REMOVING	122
EXTERNAL WIRING	122
TYPICAL CONNECTIONS	123
C-COM Connection	124
<b>SW1101</b>	<b>125</b>
FEATURES & FUNCTIONS	125
TECHNICAL SPECIFICATIONS	126
INSERTING/REMOVING PROCEDURE	127
Inserting the MEDIA	127
Removing the MEDIA	127
CHART PLOTTER DIMENSIONS	127
INSTALLATION AND REMOVING	127
EXTERNAL WIRING	128
TYPICAL CONNECTIONS	128
GPS Connection	128
Autopilot Connection	128
External NMEA Connection	129
External Alarm Connection	129
C-COM GSM PLUS Connection	130
<b>SEAWAVE<sup>3</sup></b>	<b>131</b>
FEATURES & FUNCTIONS	131
TECHNICAL SPECIFICATIONS	132
INSERTING/REMOVING PROCEDURE	132
Inserting the MEDIA	132
Removing the MEDIA	133
CHART PLOTTER DIMENSIONS	133
INSTALLATION AND REMOVING	134
EXTERNAL CONNECTIONS	134
Power & I/O and Autopilot Connection	134
External Alarm Connection	134
GPS Connection	134
AUX IN I/O and External NMEA Connection	135
Video Input Connector	135
Video Output Connector	135
C-COM Connector	135
<b>MARLIN</b>	<b>137</b>
FEATURES & FUNCTIONS	137



TECHNICAL SPECIFICATIONS .....	138
INSERTING/REMOVING PROCEDURE .....	138
Inserting the MEDIA .....	138
Removing the MEDIA .....	139
CHART PLOTTER DIMENSIONS .....	139
INSTALLATION AND REMOVING .....	139
EXTERNAL WIRING .....	140
TYPICAL CONNECTIONS .....	140
GPS Connection .....	140
Autopilot Connection .....	141
External NMEA Connection .....	141
External Alarm Connection .....	141
C-COM GSM PLUS Connection .....	141
<b>EXPLORER<sup>3</sup> .....</b>	<b>143</b>
FEATURES & FUNCTIONS .....	143
TECHNICAL SPECIFICATIONS .....	144
INSERTING/REMOVING PROCEDURE .....	144
Inserting the MEDIA .....	144
Removing the MEDIA .....	145
CONTROLLER DIMENSIONS .....	145
INSTALLATION AND REMOVING .....	145
EXTERNAL WIRING .....	146
TYPICAL CONNECTIONS .....	146
GPS Connection .....	146
Autopilot Connection .....	146
External NMEA Connection .....	147
External Alarm Connection .....	147
C-COM GSM PLUS Connection .....	148
<b>Installing the Smart GPS External SW501e/SW501ce/SW701e/SW701ce/ SW1101/SEAWAVE<sup>3</sup>/MARLIN/EXPLORER<sup>3</sup> .....</b>	<b>149</b>
INSTALLING .....	149
DIMENSIONS .....	150
<b>Analytical Index .....</b>	<b>151</b>



# About this User Manual

---

## INTRODUCTION

The chart plotter is a state-of-the-art computerized electronic chart system, designed as a sophisticated navigation aid. User friendly operations make the chart plotter easy to operate. All calculations and information necessary for the navigation are performed and displayed on the screen quickly and accurately providing all of the facilities of a conventional GPS but with the added benefit of a powerful electronic chart display. The cartographic information is obtained from C-MAP By JEPPESEN DATA MEDIA that are available through your local dealer.

For additional information on C-MAP By JEPPESEN Cartography visit web site at [www.jepesen.com](http://www.jepesen.com).

## CONVENTIONS USED

Throughout this User Manual, the labelled keys are shown in capital letters enclosed in square brackets, for example [ENTER]; the software and functions keys are shown in small letters enclosed in square brackets, for example [Edit].

Menu operations are in bold characters listed by keys sequence with the menu names enclosed between inverted commas, for example **[MENU] + "Alarms" + [ENTER]** means: press the [MENU] key, using the cursor key select the Alarms menu and then press [ENTER].

## MANUAL LAYOUT

- ◆ **CHAPTER 1: Getting Started**  
Overview of the controls and how to start using the chart plotter.
- ◆ **CHAPTER 2: Operations**  
Description of the operation procedures of the chart plotter in detail.
- ◆ **CHAPTER 3: User Setting Up**  
Set up of the chart plotter, the charting preferences and the GPS options.
- ◆ **CHAPTER 4: C-LINK**  
C-Link system is a feature used to share the same navigation data between two chart plotter units linked via serial I/O port.
- ◆ **CHAPTER 5: FISH FINDER (SW501ce/SW501ci/SW701ce/SW701ci)**  
Introduction to the basic information on the internal Fish Finder, its features and use.
- ◆ **CHAPTER 6: GPS**  
GPS antenna and set up of the hardware configuration.
- ◆ **CHAPTER 7: Maintenance**  
User maintenance guidelines.
- ◆ **Terms**  
List of the terms and abbreviations used in the User Manual.
- ◆ **SW501e/SW501i**  
Introduction to the basic information on SW501e/SW501i chart plotter, its features and use. Installation of the chart plotter.
- ◆ **SW501ce/SW501ci**  
Introduction to the basic information on SW501ce/SW501ci chart plotter with internal Fish Finder, its features and use. Installation of the chart plotter.

- ◆ **SW701e/SW701i**  
Introduction to the basic information on SW701e/SW701i chart plotter, its features and use. Installation of the chart plotter.
- ◆ **SW701ce/SW701ci**  
Introduction to the basic information on SW701ce/SW701ci chart plotter with internal Fish Finder, its features and use. Installation of the chart plotter.
- ◆ **SW1101**  
Introduction to the basic information on SW1101 chart plotter, its features and use. Installation of the chart plotter.
- ◆ **SEAWAVE<sup>3</sup>**  
Introduction to the basic information on SEAWAVE<sup>3</sup> chart plotter, its features and use. Installation of the chart plotter.
- ◆ **MARLIN**  
Introduction to the basic information on MARLIN chart plotter, its features and use. Installation of the chart plotter.
- ◆ **EXPLORER<sup>3</sup>**  
Introduction to the basic information on EXPLORER<sup>3</sup> controller, its features and use. Installation of the controller.
- ◆ **INSTALLING THE EXTERNAL SMART GPS (SW501e/SW501ce/SW701e/SW701ce/SW1101/SEAWAVE<sup>3</sup>/MARLIN/EXPLORER<sup>3</sup>)**  
Introduction to the basic information on External Smart GPS Antenna and its installation.

Analytical Index is at the end of this User Manual.

## IF YOU NEED ASSISTANCE

If your chart plotter does not operate properly, please refer to Chapter 7. Most common operating difficulties can be diagnosed using these tests.

If you still need assistance, call your local dealer, reporting the information available in the System Information page.

# 1. Getting Started

---

This chapter provides basic information to get you started using the chart plotter; it will help you in becoming familiar with the chart display and the functions of the controls before you start using the chart plotter.









## 1.1 THE KEYBOARD

### 1.1.1 Keys For SW501e/i/ce/ci, SW701e/i/ce/ci and SW1101

#### Cursor key

Moves the cursor on the display screen quickly and accurately and in the menu page(s) scrolls the desired option. If in Navigate (Home) mode, it allows to exit from Navigate mode.















#### Dedicated Keys

-  **[POWER]**
    - ◆ keep it pressed for 1 second to turn On the chart plotter
    - ◆ keep it pressed for 3 seconds to turn Off the chart plotter
    - ◆ press it to adjust the backlight and contrast of the display
  -  **[MOB]**
    - ◆ inserts the MOB (Man OverBoard) on the ship's position
  -  **[CLEAR]**
    - ◆ exits from menu or leaves a menu without making changes
    - ◆ if you are not into a menu, sets the Navigate (Home) mode: the cursor is centered on ship's position
  -  **[ENTER]**
    - ◆ places Marks, Waypoints, destination (Goto) and selects R/B
    - ◆ confirms selection
  -  **[MENU]**
    - ◆ opens the main Menu
    - ◆ when in chart and data page, keep it pressed for 3 seconds to customize data fields of the text area
  -  **[ZOOM IN]**
    - ◆ shows more details of a smaller area
  -  **[ZOOM OUT]**
    - ◆ shows a wider, less detailed area
  -  **[PAGE]**
    - ◆ selects the preferred screen configuration
- SW1101:**
-  **[DATA]**
    - ◆ opens the User Data menu (Route, Track, User Points, Save & Load)

## 1.1.2 Keys For MARLIN

### Cursor key

Moves the cursor on the display screen quickly and accurately and in the menu page(s) scrolls the desired option. If in Navigate (Home) mode, it allows to exit from Navigate mode.





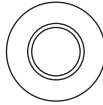

-  **[POWER]**
  - ◆ keep it pressed for 1 second to turn On the chart plotter
  - ◆ keep it pressed for 3 seconds to turn Off the chart plotter
  - ◆ press it to adjust the brightness of the display
-  **[MOB]**
  - ◆ inserts the MOB (Man OverBoard) on the ship's position
-  **[CLEAR]**
  - ◆ exits from menu or leaves a menu without making changes
  - ◆ if you are not into a menu, sets the Navigate (Home) mode: the cursor is centered on ship's position
-  **[ENTER]**
  - ◆ places Marks and Waypoints; selects the A/B, EBL/VRM, Info and Find functions; confirms selection
-  **[MENU]**
  - ◆ opens the main Menu
  - ◆ when in chart and data page, keep it pressed for 3 seconds to customize data fields of the text area
-  **[ZOOM IN]**
  - ◆ shows more details of a smaller area
-  **[ZOOM OUT]**
  - ◆ shows a wider, less detailed area
-  **[GOTO]**
  - ◆ selects the Goto function
-  **[INFO]**
  - ◆ selects the Info function
-  **[DATA]**
  - ◆ selects the preferred screen configuration
-  **[EVENT]**
  - ◆ places Event at vessel's position
-  **[MARK]**
  - ◆ places Mark at the cursor position
-  **[ROUTE]**
  - ◆ places Waypoint at the cursor position
-  **[TRACK]**
  - ◆ selects the Track menu

### 1.1.3 Keys For EXLORER<sup>3</sup>

#### Cursor key (Joystick)



Moves the cursor on the display screen quickly and accurately and in the menu page(s) scrolls the desired option. If in Navigate (Home) mode, it allows to exit from Navigate mode.





-  **[POWER]**
  - ◆ keep it pressed for one second to turn On the chart plotter
  - ◆ keep it pressed for three seconds to turn Off the chart plotter
  - ◆ press it to adjust the Keys Light
-  **[MOB]**
  - ◆ inserts the MOB (Man OverBoard) on the ship's position
-  **[CLEAR]**
  - ◆ exits from menu or leaves a menu without making changes
  - ◆ if you are not into a menu, sets the Navigate (Home) mode: the cursor is centered on ship's position
-  **[ENTER]**
  - ◆ places Marks, Waypoints, destination; selects R/B, Info and Find functions; confirms selection
-  **[MENU]**
  - ◆ opens the main Menu
  - ◆ when in chart and data page, keep it pressed for 3 seconds to customize data fields of the text area
-  **[ZOOM IN]**
  - ◆ shows more details of a smaller area
-  **[ZOOM OUT]**
  - ◆ shows a wider, less detailed area

### 1.1.4 Keys For SEAWAVE<sup>3</sup>

#### Cursor key (Joystick)



Moves the cursor on the display screen quickly and accurately and in the menu page(s) scrolls the desired option. If in Navigate (Home) mode, it allows to exit from navigate mode.

-  **[POWER]**
  - ◆ keep it pressed for one second to turn On the chart plotter
  - ◆ keep it pressed for three seconds to turn Off the chart plotter
-  **[DISPLAY +/-]**
  - ◆ adjusts the LCD and keypad backlight
-  **[CONTRAST +/-]**
  - ◆ adjusts the LCD contrast
-  **[1]**
  - ◆ Numeric key or moves cursor top left corner
-  **[2 ABC]**
  - ◆ Numeric/letter key or moves cursor top



- ◆ Numeric/letter key or moves cursor top right corner



- ◆ Numeric/letter key or moves cursor left



- ◆ Numeric/letter key or centers the map at the current cursor position. If Navigate (Home) mode is set the map is already centered on the map display



- ◆ Numeric/letter key or moves cursor right



- ◆ Numeric/letter key or moves cursor bottom left corner



- ◆ Numeric/letter key or moves cursor bottom



- ◆ Numeric/letter key or moves cursor bottom right corner



- ◆ Numeric key



- ◆ selects the preferred screen configuration



- ◆ opens the main Menu
- ◆ when in chart and data page, keep it pressed for 3 seconds to customize data fields of the text area



- ◆ selects the Goto function



- ◆ inserts l'Event on the ship's position
- ◆ long press inserts the MOB (Man OverBoard); long press when the MOB is already present deletes it.



- ◆ places EBL and VRM



- ◆ selects the Track menu



- ◆ exits from menu or leaves a menu without making changes
- ◆ if you are not into a menu, sets the Navigate (Home) mode: the cursor is centered on ship's position



- ◆ confirms selection
- ◆ places Marks, Waypoints, and selects EBL/VRM, R/B, Info, Find



- ◆ shows more details of a smaller area



- ◆ shows a wider, less detailed area



- ◆ selects the Info function

### 1.1.5 Software Keys<sup>1</sup>

The software keys (soft keys) have different functions according to the modes of operation: their labels for the current functions, located on the front panel, are shown on the screen right above the keys. Also they are used from the chart screen or from the data pages to select one of the data pages available to allow faster access to the page selection.

When the chart page is selected, the soft key labels are not shown. By pressing one of the four soft keys their labels for the current functions are shown on the screen immediately above the soft keys. When the soft key labels are shown, by



pressing the associated soft key the relative function is executed. By pressing **[CLEAR]** the four soft key labels disappear.

**NOTE<sup>1</sup> NOT AVAILABLE FOR SEAWAVE<sup>3</sup>.**

### SEAWAVE<sup>3</sup>:

#### 1.1.6 Function Keys

When the cursor is placed over any User Point or any cartographic object, a window containing the information about the selected object is shown on a variable location of the screen (not covering the cursor icon). At the same time some Function Keys (up to five) are shown on the bottom of the page. The Function Keys are associated to the function that can be applied to the selected object. Each Function Key shows a number and the name of the function.

For example when the cursor is placed over a Mark, the information window with Coordinates, Name, Icon and all other Mark information is shown. The following Functions Keys are shown on the bottom of the map display.



Fig. 1.1.6 - Example of Function Keys

Pressing any numerical keys from **[1]** to **[5]**, the function associated to the selected number is executed. Otherwise pressing any numerical key not active (not associated to any function) 3 beeps will be sounded and the Function Keys are kept shown. Pressing **[CLEAR]** the Functions Keys are removed from the screen, pressing any other key the Functions Keys will be closed and the function associated to the pressed key will be executed.

#### 1.1.7 Software/Function Keys Customization

When the soft keys labels are shown the user can customize them. Pressing and holding down any of the soft key shows a pop-up window on the top of the soft key pressed that contains all possible data pages assignable to the soft key pressed.

##### Only For SEAWAVE<sup>3</sup>:

In all data pages the user can customize the Function Keys. Pressing and holding down for 1 second the numeric key **[1]**, **[2]**, **[3]**, **[4]**, **[5]** it will be possible to assign a different selection to the relative Function Key.

Move the cursor key up/down to place the selector on the desired item; move the cursor key to the right or press **[ENTER]** to set the selected item; move the cursor key to the left or press **[CLEAR]** to close the pop-up window.

The possible choices are:

- ♦ CHART [Chart] (Chart Display page)
- ♦ NAVIGATION [Nav Data] (Navigation Data page)

- ◆ 3D ROAD [3D Road] (3D Road page)
- ◆ GPS STATUS [Status] (GPS Status page)
- ◆ WIND DATA<sup>1</sup> [WindData] (Wind Data page)
- ◆ GAUGES [Gauges] (Gauges page)
- ◆ DEPTH FULL [Depth 1] (Depth Graph Full page)
- ◆ DEPTH [Depth 2] (Depth Graph page)
- ◆ FISH FINDER [FF Std] (Fish Finder Full page)
- ◆ FISH FINDER [FF Dual] (Fish Finder Dual Frequency page)
- ◆ FISH FINDER [FF Splt] (Fish Finder Zoom page)
- ◆ FISH FINDER [FF+Map] (Fish Finder and Chart page)
- ◆ RADAR<sup>2</sup> [Rd Std] (Radar Full page)
- ◆ RADAR<sup>2</sup> [Rd+Map] (Radar and Chart page)
- ◆ RADAR<sup>2</sup> [Rd+FF] (Radar and Fish Finder page)
- ◆ RADAR<sup>2</sup> [Rd+Data] (Radar and data page)
- ◆ RADAR<sup>2</sup> [Combo 4] (Radar, Fish finder, Chart and data page)
- ◆ ADD VIDEOCAMERA<sup>4</sup> [AddVid] (Add screen video image)
- ◆ ADD VIDEOCAMERA 1<sup>3</sup> [AddVid1] (Add screen video image 1)
- ◆ ADD VIDEOCAMERA 2<sup>3</sup> [AddVid2] (Add screen video image 2)
- ◆ VIDEOCAMERA<sup>4</sup> [Video] (Full screen video image)
- ◆ VIDEOCAMERA 1<sup>3</sup> [Video 1] (Full screen video image 1)
- ◆ VIDEOCAMERA 2<sup>3</sup> [Video 2] (Full screen video image 2)
- ◆ MARK [Mark] (Mark place)
- ◆ EVENT [Event] (Event place)
- ◆ WAYPOINT [Waypoint] (Waypoint place)
- ◆ TRACK [Track] (Track storing activated/deactivated)

**NOTE<sup>1</sup>** AVAILABLE FOR SW701e/SW701i/SW701ce/SW701ci/SW1101/MARLIN/EXPLORER<sup>3</sup>.

**NOTE<sup>2</sup>** AVAILABLE FOR SW701e/SW701i/SW701ce/SW701ci/SW1101/MARLIN/EXPLORER<sup>3</sup>/SEAWAVE<sup>3</sup>.

**NOTE<sup>3</sup>** AVAILABLE FOR SW1101/MARLIN/SEAWAVE<sup>3</sup>.

**NOTE<sup>4</sup>** AVAILABLE FOR SW701e/SW701i/SW701ce/SW701ci.

### 1.1.8 Alphanumeric Input Procedure<sup>1</sup>

**NOTE<sup>1</sup>** NOT AVAILABLE FOR EXPLORER<sup>3</sup>.

When editing a Waypoint (see the following picture) or when entering menu information, insert data by using the visual alphabetical table shown:

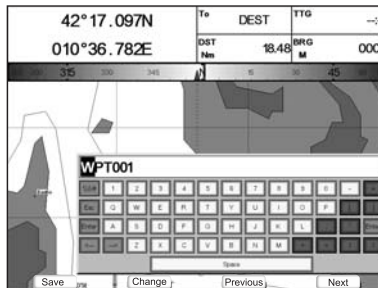

Fig. 1.1.8 - Example of Visual Alphabetical table

The table shows all the characters usable. Use the cursor key to go through the available characters and select the requested one. The four soft keys are now activated to:

- ♦ [Save] : to save when the entry is complete. After pressing [Save] the Soft Keys disappear: press [Accept] to end the input procedure
- ♦ [Change] : to switch between numeric/non-numeric digits
- ♦ [Previous]: to go back to previous page
- ♦ [Next] : to move to next page

#### **Only For SEAWAVE<sup>3</sup>:**

The following virtual keys on the visual keyboard are now activated to:

- ♦ [%&#] : to switch between numeric/non-numeric digits
- ♦ [<-] : to go back to previous digit
- ♦ [->] : to move to next digit
- ♦ [Enter] : to save when the entry is complete.

Press [1, Accept] to end the input procedure

## **1.2 SWITCHING ON/OFF**

Before powering On the chart plotter, check for the correct voltage (10-35 volt dc) and the correct connections with the positioning instrument.

### **Switching On**

- **[POWER] for 1 second**

In the opening page, underneath the Seiwa logo, you will find the software version and type. The next page is the First Setup page (see Par. 1.3) which is activated only when the chart plotter is turned on for the first time and after a Master reset. Then the chart plotter will automatically show the Jeppesen warning page and the GPS Status page. Pressing **[CLEAR]** at this stage to activate the cartography page.

### **Switching Off**

- **[POWER] for 3 seconds**

A countdown timer appears on the screen, if you release the key before the countdown timer reaches zero, the chart plotter will remain On.

#### **EXPLORER<sup>3</sup>:**

**NOTE** *The default resolution is 800x600 (manufactory condition or after a CLEAR RAM operation). If connected to a monitor without a different resolution, it is possible that the image is not shown. So you should set the proper resolution for the monitor in use (see the monitor manual and the Par. 6.1.7).*

## **1.3 FIRST SETUP PAGE**

This menu allows you to configure the chart plotter and the external devices the first time the chart plotter is powered On. This information can be changed at any time either from the General Options menu (see Par. 3.1) or by resetting the chart plotter. Select the correct setup option and press **[ENTER]**, when complete press **[OK]**<sup>1</sup> to exit.

**NOTE<sup>1</sup>** *For SEAWAVE<sup>3</sup>, press [1, OK].*

First Setup Page	
Language	English
Chart Language	▶
Distance Units	Nm
Speed Units	Kts
Wind Units	Kts
Depth Unit	Mt
Altitude Units	Mt
Temperature Units	°C
Time Reference	UTC
Daylight Saving Time	Off
Time Format	24 hour
Date Format	DD-MM-YY
Nav-Aids Presentation	INT
Keypad Beep	Off
Cursor Speed	▶
Devices	▶
Simulation Mode	▶

Fig. 1.3 - First Setup page menu

The possible selections are listed in the table below:

<b>Language</b>	: The map information will still be displayed in the language of the official digitalized paper chart
<b>Chart Language</b>	: Selects a sub-menu with two items: <b>Language</b> to set the language to display chart information and <b>Mode</b> to define how objects are translated.
<b>Distance Units</b>	: Selects the unit for Distance among Nm, Sm, Km.
<b>Speed Units</b>	: Selects the unit for Speed among Kts, Mph, Kph.
<b>Wind Units</b>	: Selects the unit for Wind among Kts, Kph, Mph, m/s, Bft.
<b>Depth Unit</b>	: Selects the unit among Ft, FM and Mt.
<b>Altitude Units</b>	: Selects the unit among Ft, FL and Mt.
<b>Temperature Units</b>	: Selects the unit among °C and °F.
<b>Time Reference</b>	: Allows switching between UTC or local time, by entering the Local Time offset.
<b>Daylight Saving Time</b>	: Sets On/Off the Daylight Saving Time.
<b>Time Format</b>	: Selects the format for the time between 12 and 24 hours.
<b>Date Format</b>	: Selects the Date Format between MM-DD-YY (month-day-year) and DD-MM-YY (day-month-year).
<b>Nav-Aids Presentation</b>	: Allows to set the Nav Aids presentation as US (Draw Nav-Aids using NOAA symbology) or INTERNATIONAL (Draws Nav-Aids using international symbology). When selected it affects Lights, Signals, Buoys & Beacons display.
<b>Keypad Beep</b>	: Enables or disables the single audio beeps emitted any time the chart plotter keypad is pressed. If the incorrect key is pressed or the function required cannot be executed, the chart plotter emits three beeps.
<b>Cursor Speed</b>	: Selects the Cursor Speed among Low, Medium or High in Chart page or into menu.
<b>Devices</b>	: Allows to setup the devices that needs a dedicated port as C-Com, BBF 50/200 <sup>2</sup> , Radar <sup>3</sup> and AIS 38400.
<b>Simulation Mode</b>	: Allows to setup the simulation data before use the Simulation function.

NOTE<sup>2</sup> ONLY FOR SW1101/SW501e/SW501i/SW701e/SW701i/MARLIN/EXPLORER<sup>3</sup>/SEAWAVE<sup>3</sup>.

NOTE<sup>3</sup> ONLY FOR SW1101/SW701e/SW701i/SW701ce/SW701ci/MARLIN/EXPLORER<sup>3</sup>/SEAWAVE<sup>3</sup>.

## 1.4 CHANGING BACKLIGHT AND CONTRAST

You can change the level of backlight and contrast for the screen.

- ▶ [POWER] + use [Bright-]/[Bright+] to adjust backlight levels and/or use [Contr-]/[Contr+] to adjust contrast levels + [ENTER]

**MARLIN:**

- [POWER] + [Bright-]/[Bright+] to adjust brightness + [ENTER]

**SEAWAVE<sup>3</sup>:**

- [DISPLAY-]/[DISPLAY+] to adjust backlight levels and/or use [CONTRAST-]/[CONTRAST+] to adjust contrast levels + [ENTER]

**EXPLORER<sup>3</sup>:**

- [POWER] + use [Key-]/[Key+] to adjust keys light levels + [ENTER]

Now you return to the chart screen with the new light levels retained.

## 1.5 SELECTING THE LANGUAGE

It is possible to set the language to display menus, data pages, warning/alarm messages, full/quick info, list of objects found by find/nearest function, and on charts (such as place's names, buoy's names and so on).

To select the language you want:

- [MENU] + "General Options" + [ENTER] + "Language" + [ENTER] + select the language you want + [ENTER]

**NOTE** *If the selected language is not available on cartographic data, English language is used instead.*

### CAUTION

*If you have accidentally selected an unknown language, and you are not able to select your preferred language please see Chapter 7 "Maintenance" for a RAM Clear operation: the chart plotter will also return all selections, in particular language, to original default values.*

## 1.6 SELECTING THE CHART LANGUAGE

- [MENU] + "General Options" + [ENTER] + "Chart Language" + [ENTER] + select the language you want + [ENTER]

The possible choices are listed in the table below:

<b>Language:</b>	Allows setting the language to display chart information. The language is chosen among the list of languages available on the cartographic data (DATA MEDIA or embedded charts).
<b>Mode:</b>	Defines how objects are translated. It is possible to choose between the three following options: <ul style="list-style-type: none"> <li>Off Uses the same Language used for LANGUAGE. If the selected language is not present on the objects information, English is used instead;</li> <li>English Always uses English;</li> <li>Local Uses the first Local language present on data. If no Local language is available, English is used instead.</li> </ul>

- NOTE**
- a. *When User Interface Language is changed, Chart Language settings are set as follows: MODE is set to Off and Chart Language is set as the User Interface Language selection if available on the chart data, otherwise is set to English.*
  - b. *If the cartographic data is changed (for example the DATA MEDIA is removed or replaced), Chart Language settings should be verified and if necessary changed.*

## 1.7 C-MAP BY JEPPESEN MAX CARTOGRAPHY INFORMATION

MAX is a major evolution of the product technology. Key points are:

### Data Features

- ◆ **ISO Certification** *(electronic chart production process with quality certification)*

- **Extra Large Coverage** (all the C-MAP By JEPPESEN electronic chart detail and a huge coverage without having to change data media)
- **Official data source** (data based on use of official data sources)
- **Detailed World Background** (worldwide background chart with details)
- **Depths & Land Elevation** (color shading of sea depth and land altitude for improved chart reading)
- **Bathymetric & Spot Soundings** (additional Data Base with depth and bathy information for an extraordinary view of the seabed depth)
- **Detailed Port Plan** (complete port and marina charts with detail)
- **Search & Find** (quickly locates chart contents and objects)
- **Tides Preview** (dynamic simulation of tides)
- **Dynamic Currents** (current arrows dynamically display direction and speed)
- **Dynamic Nav-Aids** (displays Nav-Aids in true color and with real interval lighting)
- **Port Info** (all the information of the available services in the ports and how to contact them)
- **Enhanced Port Info & Roads** (details of the available facilities and services in ports and surrounding areas)
- **Object Info** (indicates restricted area details and related information)
- **Quick Info** (full information on objects, buoys, wrecks, shoals and Nav-Aids)
- **Photos & Diagrams** (high definition pictures of ports, piers, bridge diagrams and nav-aids)
- **Multilanguage Support** (displays charts in the local character set)
- **True-Type Font** (improves text on chart for optimal reading)

## Presentation Features

- **Clear View** (advanced legibility techniques providing more chart data on the screen)
- **Clear Info** (sophisticated "Human Dictionary" to translate Nav-Aid abbreviations found on paper charts)
- **Dynamic Nav-Aids** (an innovative and dynamic presentation mode)
- **Flexi-Zoom** (increased Under and Over Zoom between chart levels, resulting in optimal scale display for any situation)
- **Dynamic Elevation Data** (optimized palettes including the NOAA color palette)
- **Perspective View** ("Real World" perspective view of the chart, updated real-time during navigation)
- **Smooth-Zoom** (smooth transition of cartographic levels)
- **Enhanced Turbo-Zoom** (extra fast cartography level change displaying the most important cartographic objects)
- **Enhanced Mixing Levels** (seamless data presentation)
- **Off-line redraw** (cartography level transition without image construction)

## Cartographic Data related Features

- **Guardian Alarm** (automatic control and alarm over obstacles on charts in front of your boat)
- **Safety Toolbar** (interactive alarm system for situational awareness on screen)
- **Safety Route Check** (sophisticated function checking dangerous objects along your navigation route)

## 1.8 USING C-MAP BY JEPPESEN DATA MEDIA

The chart plotter has a built-in world map. To use the chart plotter as a navigation aid, DATA MEDIA with detailed information for the area you wish to navigate are required. See the technical details of your chart plotter for inserting/removing DATA MEDIA procedure.

**NOTE** *During normal operations the DATA MEDIA should not be removed since the chart plotter may lock up.*

## 1.9 SIMULATION MODE

The built-in Simulator function allows you to become proficient in the use of the chart plotter. It simulates the reception of the navigation data (Lat/Lon, Course, Speed, date, time). The simulated ship's position is placed at the current cursor position by the time the simulation is activated. To start the Simulator:

- Place the cursor at your desired position + [MENU] + "Advanced Options" + [ENTER] + "Simulation Mode" + [ENTER] + "Simulation Mode" + [ENTER] + "On" + [ENTER]

You might insert the Speed, Heading, date and time values:

- [MENU] + "Advanced Options" + [ENTER] + "Simulation Mode" + [ENTER] + "Speed"/"Heading"/"Date"/"Time" + [ENTER] + enter values + [ENTER]

To select the Cursor Control in Chart page use the cursor up/down to adjust the Speed and the cursor left/right to adjust the Course:

- [MENU] + "Advanced Options" + [ENTER] + "Simulation Mode" + [ENTER] + "Cursor Control" + [ENTER] + "On" + [ENTER]

## 1.10 CONTROLLING THE DISPLAY

This paragraph describes how to change the display mode and how to move around the chart by changing the chart scale.

### Changing Display Mode

- [PAGE]

MARLIN:

- [DATA]

EXPLORER<sup>3</sup>:

- [MENU] + "Page" + [ENTER]

An icons<sup>1</sup> menu appears on the screen: it shows the available pages.

**NOTE<sup>1</sup>** *NOT AVAILABLE FOR Explorer<sup>3</sup>. An items menu is shown in place of the icons menu.*

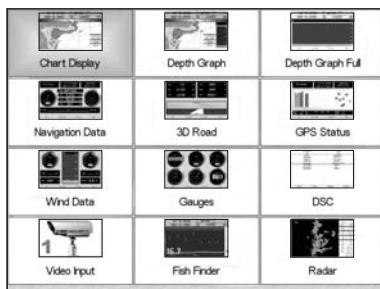

Fig. 1.10 - Example of Page selection menu on SW1101

Move the cursor to select the page you want and the press [ENTER]: the selected page (or another icons menu!) appears.

In the following figures examples of pages are shown. Please notice that for some chart plotters the boxes position may differ depending on the configuration chosen.

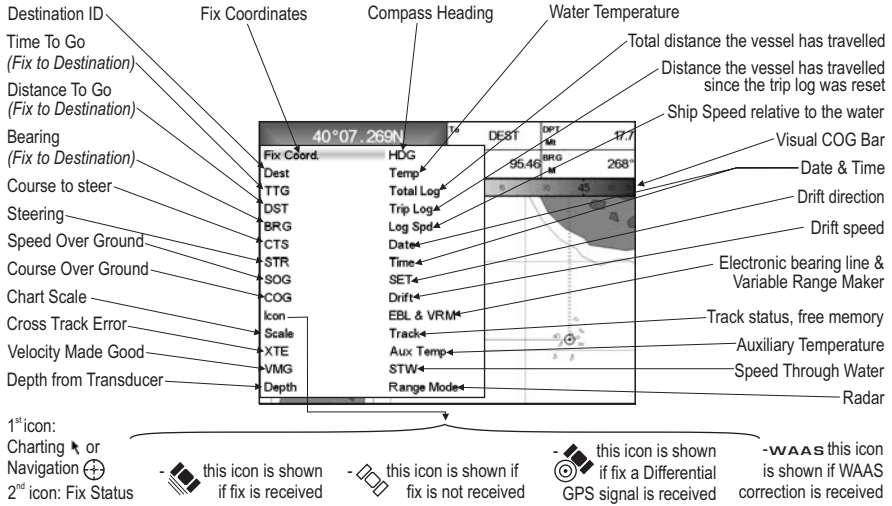

Fig. 1.10a - Example of Chart Display page

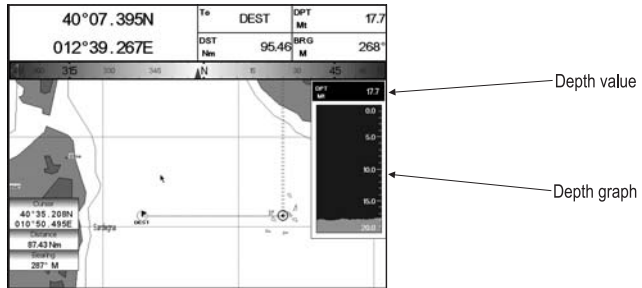

Fig. 1.10b - Example of Depth Graph page

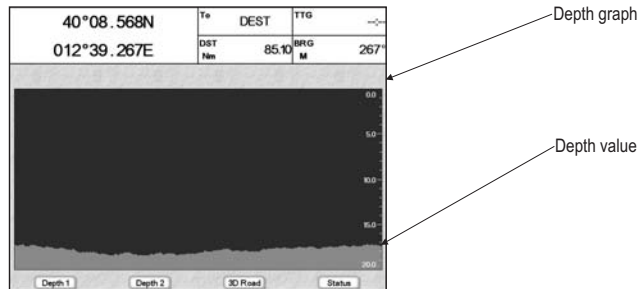

Fig. 1.10c - Example of Depth Graph Full page



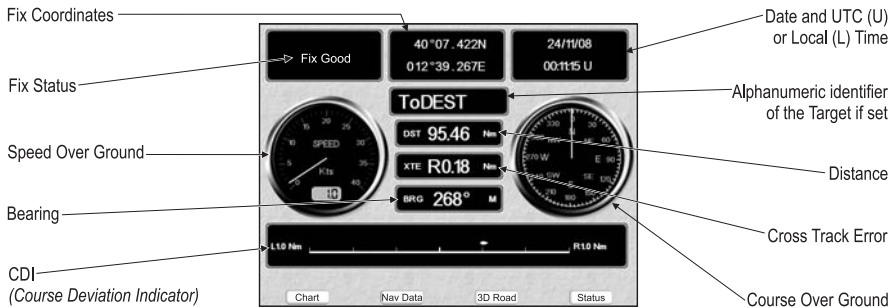

Fig. 1.10d - Example of Navigation Data page

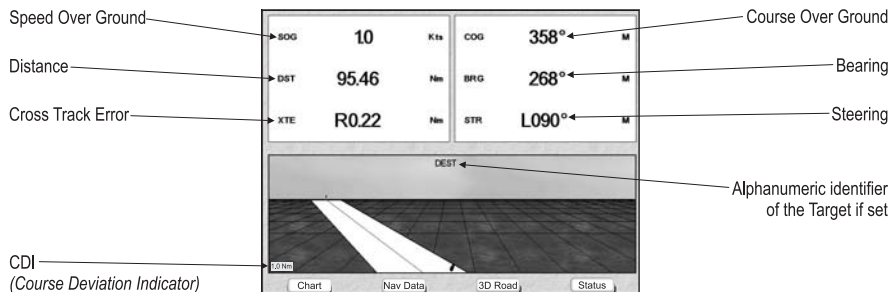

Fig. 1.10e - Example of 3D Road page

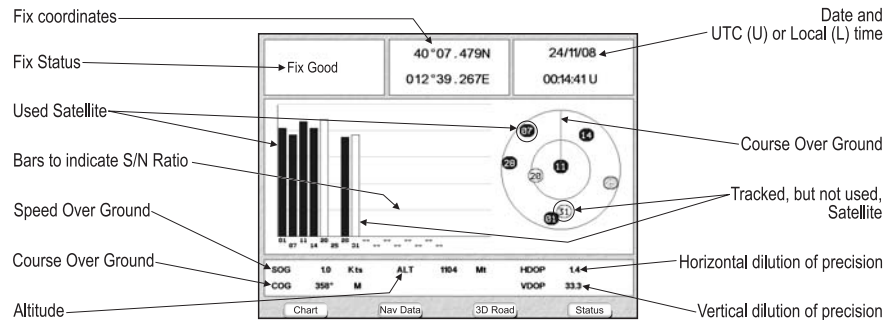

Fig. 1.10f - Example of GPS Status page

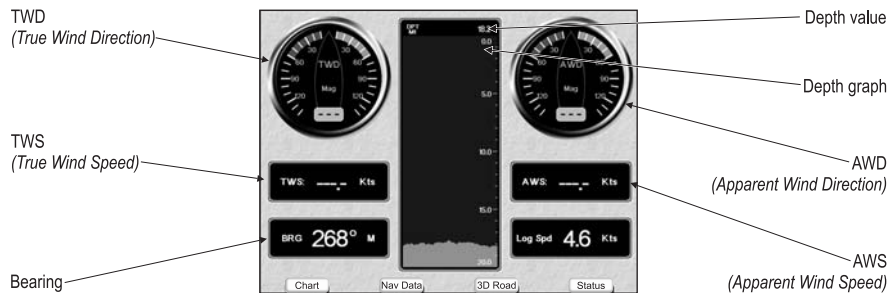

Fig. 1.10g - Example of Wind Data page<sup>1</sup>

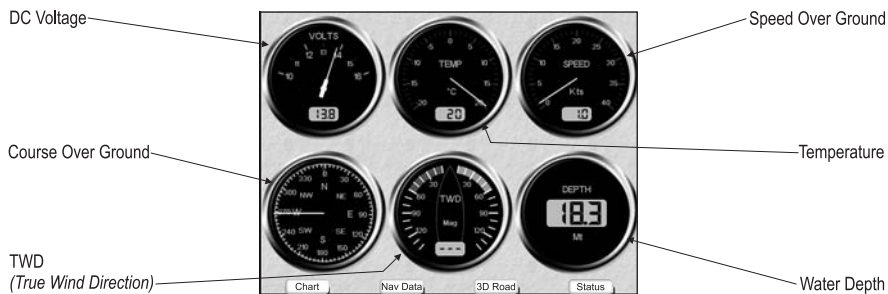

Fig. 1.10h - Example of Gauges page<sup>2</sup>

**NOTE<sup>1</sup>** *NOT AVAILABLE FOR SW501e/SW501i/SW501ce/SW501cl/SEAWAVE<sup>3</sup>.*

**NOTE<sup>2</sup>** *The numbers of analogue instruments may be different.*

## Moving around the Chart and Changing Chart Scale

Use the cursor key to move around the chart. Also use **[ZOOM IN]** and **[ZOOM OUT]** to change the chart scale so that a smaller or larger area is shown on the chart. Now it is possible to change smoothly the zoom level avoiding the big jump between levels.

## Finding Your Boat Position

The most common use of the chart plotter is to show your ship's current location. You can lock the cursor to the ship's position using:

- **[CLEAR]**

The Home function locks the cursor to the ship and updates the display as the ship moves. To release the cursor from the Home Mode, use the cursor key to move the cursor away from the ship's current position.

## Selecting Screen Amplifier

In Home mode the Screen Amplifier function sets up the charts on the navigation direction (course) in order to display more map details in front of the ship's position.

- **[CLEAR] + [MENU] + "Display Options" + [ENTER] + "Screen Amplifier" + [ENTER] + "On" + [ENTER]**

## Selecting Map Orientation

To select the orientation of your chart according to:

- **[MENU] + "Map Options" + [ENTER] + "Map Orientation" + [ENTER]**

The available choices are North Up (the map is shown with North upwards), Head Up (the map is shown with the ship's current heading upwards) and Track Up (the map is shown with the currently selected course leg upwards).

If Head Up or Track Up has been selected, the Resolution angle can be set:

- **[MENU] + "Map Options" + [ENTER] + "Map Orientation" + [ENTER] + "Head Up" or "Track Up" + [ENTER] + use cursor to insert values + [ENTER]**

The Resolution angle, which may be selected in the range [5 – 60] degrees, defines the maximum variation of the reference angle after which the map changes its orientation.

## 1.11 NAVIGATION TO A SINGLE DESTINATION

To place the destination at cursor coordinates and activates navigation to it:

- Place the cursor on location to navigate to + [ENTER] + "GOTO" + [ENTER]

### MARLIN/SEAWAVE<sup>3</sup>:

- Place the cursor on location to navigate to + [GOTO]

You are now navigating to the destination drawn as a Mark with a circle around it, labelled "DEST". A straight line is shown on the screen connecting the destination with the ship's position. All navigation data is referred to this destination.

### MARLIN/SEAWAVE<sup>3</sup>:

## 1.12 A-B FUNCTION

The A-B function allows to measure the Lat/Lon coordinates between two points on the Chart page.

### Inserting A-B

- [ENTER] + "A-B" + [ENTER]

The "A" point is positioned on the cursor position. Use the cursor key to move the cursor in the desired place and then to place the "B" point press:

- [ENTER] + "A-B" + [ENTER]

A straight line connects the two points "A" and "B". A window containing the distance and bearing values is shown.

### Deleting A-B

- Place the cursor on existing A-B + [Clear]<sup>1</sup>

Deletes the A and B points and the line.

**NOTE<sup>1</sup>** For SEAWAVE<sup>3</sup>, press [1, Clear].

## 1.13 RANGE/BEARING<sup>1</sup> FUNCTION

The Range/Bearing function allows to measure the Lat/Lon coordinates between two points on the Chart page.

**NOTE<sup>1</sup>** For MARLIN/SEAWAVE<sup>3</sup>: The Range and Bearing (R/B) function is called EBL/VRM function. EBL (Electronic Bearing Line) is a dot line: the origin of the line is the cursor position. VRM (Variable Range Marker) is a circle and its radius is determined by the user. So in the commands sequence below, there is "EBL/VRM" in place of "R/B".

### Inserting R/B

- [ENTER] + "R/B" + [ENTER]

### SEAWAVE<sup>3</sup>:

- [EBL/VRM]

A dotted line and a circle appears on the screen. A window containing the distance and bearing values is shown. The origin of the line and the circle's centre is the cursor position: use the cursor key to move the dotted line in any direction you choose; in the same time the radius changes. Press [**Accept**]<sup>1</sup> to confirm ([**Cancel**]<sup>1</sup> otherwise).

**NOTE<sup>1</sup>** For SEAWAVE<sup>3</sup>, press [1, Accept] or [2, Cancel].

### Deleting R/B

- Place the cursor on existing R/B + [Delete]<sup>1</sup>

Deletes the line and the circle.

**NOTE<sup>1</sup>** For SEAWAVE<sup>3</sup>, press [1, Delete].

## Editing R/B

- **Place the cursor on existing R/B + [Edit]**<sup>1</sup>

Modifies the line direction and the circle radius. Use the cursor key to move the dotted line in any direction you choose; in the same time the radius changes. Press **[Accept]**<sup>2</sup> to confirm (**[Cancel]**<sup>2</sup> otherwise).

**NOTE**<sup>1</sup> For SEAWAVE<sup>®</sup>, press [2, Edit].

**NOTE**<sup>2</sup> For SEAWAVE<sup>®</sup>, press [1, Accept] or [2, Cancel].

## 1.14 MAN OVERBOARD (MOB)

If a person or object is lost overboard and you need to return to the location, use the MOB (Man OverBoard) function.

To activate the MOB function, a valid GPS fix must be available.

### Inserting MOB

- **[MOB]**

If MOB is already placed removes the existing MOB and places a new one.

Once inserted, the system performs the following operations:

1. places the MOB icon at ship's position
2. stops navigation to an existing destination (if present)
3. sets the MOB as destination

### Selecting Auto Info on MOB

- **Place the cursor on MOB symbol**

An information window appears, showing the bearing and distance to the MOB position.

### Deleting MOB

- **[MOB] + [Confirm]**<sup>1</sup>

**NOTE**<sup>1</sup> For SEAWAVE<sup>®</sup>, press [1, Confirm].

## 2. Operations

---

### 2.1 USER POINTS: MARKS, EVENTS AND WAYPOINTS

A User Point is an object that you can place on the charts to mark a specific point. The chart plotter features three types of User Points: Marks, Events and Waypoints. A Waypoint is created entering a Route, a Mark can be created on the cursor's position while an Event is created on ship's position.

#### Creating Waypoint

See Creating a Route.

#### Creating Mark

- [ENTER] + "MARK" + [ENTER]

The new Mark appears on your cursor's position if not in Home mode.

#### MARLIN:

- [MARK]

#### Creating Event

- [ENTER] + "MARK" + [ENTER]

The new Event appears on your ship's position if in Home Mode.

#### MARLIN/SEAWAVE<sup>3</sup>:

- [EVENT]

#### Editing User Point

To allow to modify name, symbol, color and position (not for Event) of the User Point.

If in Chart page:

- Place the cursor on the desired User Point + [Edit]<sup>1</sup> + use the cursor key to modify Name/Symbol/Lat-Lon (not for Event)/Color + [Accept]<sup>1</sup>

**NOTE<sup>1</sup>** For SEAWAVE<sup>3</sup>, press [3, Edit] and [1, Accept].

The User Point appears on the selected position with the new symbol and color.

**NOTE** To select the User Point presentation:

- [MENU] + "Display Options" + [ENTER] + "User Points" + [ENTER]  
There are three possible choices: by selecting Off the User Point is not shown on the screen, otherwise by selecting On it is shown on the Chart page shown with symbol and name; by selecting Icon only the User Point symbol is shown.

#### Deleting User Point

If in Chart page:

- Place the cursor on the desired User Point + [Delete] + [Accept]<sup>1</sup>

**NOTE<sup>1</sup>** For SEAWAVE<sup>3</sup>, press [2, Delete] and [1, Accept].

If in User Points List page:

- [MENU] + "User Points" + [ENTER] + "List" + [ENTER] + use the cursor to select the row with the desired User Point + [Delete] + [Yes]<sup>2</sup>

**NOTE<sup>2</sup>** For SEAWAVE<sup>3</sup>, press [4, Delete] and [1, Yes].

#### SW1101:

- [DATA] + "User Points" + [ENTER] + "List" + [ENTER] + use the cursor to select the row with the desired User Point + [Delete] + [Yes]

The User Point is deleted.

It is also possible to delete all stored User Points. If in User Points List page:

- [MENU] + "User Points" + [ENTER] + "List" + [ENTER] + [Delete] + [Del All] + [Yes]<sup>3</sup>

NOTE<sup>3</sup> For SEAWAVE<sup>3</sup>, press [3, Del All] and [1, Yes].

SW1101:

- [DATA] + "User Points" + [ENTER] + "List" + [ENTER] + [Delete] + [Del All] + [Yes]

## Moving User Point

- Place the cursor on the desired User Point + [Move] + move the cursor to the desired position + [Accept]<sup>1</sup>

The User Point is placed on the screen at the new position.

NOTE<sup>1</sup> For SEAWAVE<sup>3</sup>, press [1, Move] and [1, Accept].

## Locating User Point on Map

If in Chart page:

- [ENTER] + "Find" + [ENTER] + "User Points" + [ENTER] + insert name of the User Point to show on map + [Save]<sup>1</sup>

The map is centered on the selected User Point.

If in User Points List page:

- [MENU] + "User Points" + [ENTER] + "List" + [ENTER] + use the cursor to select the row with the desired User Point + [ENTER]

SW1101:

- [DATA] + "User Points" + [ENTER] + "List" + [ENTER] + use the cursor to select the row with the desired User Point + [ENTER]

Otherwise:

- [MENU] + "User Points" + [ENTER] + "List" + [ENTER] + [Find]<sup>2</sup> + insert name of the User Point to show on map + [Save]<sup>1</sup>

NOTE<sup>1</sup> For SEAWAVE<sup>3</sup>, press [1, Save].

NOTE<sup>2</sup> For SEAWAVE<sup>3</sup>, press [1, Find].

SW1101:

- [DATA] + "User Points" + [ENTER] + "List" + [ENTER] + [Find] + insert name of the User Point to show on map + [Save]

The split displayed map is centered on the selected User Point.

## Sending/Receiving User Point

To send all User Points to an external device through the serial port:

- [MENU] + "User Points" + [ENTER] + "Send" + [ENTER]

SW1101:

- [DATA] + "User Points" + [ENTER] + "Send" + [ENTER]

To read User Points from the NMEA input port:

- [MENU] + "User Points" + [ENTER] + "Receive" + [ENTER]

SW1101:

- [DATA] + "User Points" + [ENTER] + "Receive" + [ENTER]

## Selecting User Points List page

To give information and allow the editing of all stored User Points:

- [MENU] + "User Points" + [ENTER] + "List" + [ENTER]

SW1101:

- [DATA] + "User Points" + [ENTER] + "List" + [ENTER]

From this page it is possible the creation of a Route with User Points:

- [MENU] + "User Points" + [ENTER] + "List" + [ENTER] + [Route]<sup>1</sup> + use the cursor key to highlight the Route + [Select]<sup>1</sup>

#### SW1101:

- [DATA] + "User Points" + [ENTER] + "List" + [ENTER] + [Route] + use the cursor key to highlight the Route + [Select]

It is possible to link the User Point to the selected Route. If the selected User Point is already linked to the Route, the same procedure is used to disconnect it from Route:

- [MENU] + "User Points" + [ENTER] + "List" + [ENTER] + [Route+]<sup>2</sup>

NOTE<sup>1</sup> For SEAWAVE<sup>3</sup>, press [2, Route] and [ENTER].

NOTE<sup>2</sup> For SEAWAVE<sup>3</sup>, press [3, Route+].

#### SW1101:

- [DATA] + "User Points" + [ENTER] + "List" + [ENTER] + [Route+]

## 2.2 ROUTES

A Route is made by placing a series of Waypoints or by linking existing Marks. Among the available Routes only one can be the Active Route, that is shown on the screen by straight lines and arrows to indicate the direction; the first Waypoint of this Route is surrounded by a circle. The Active Route (sometimes called current) is the working Route: it can be edited by adding, removing or moving Waypoints.

### Selecting Active Route

- [MENU] + "Route" + [ENTER] + "Select" + [ENTER] + use the cursor key to highlight the Route + [Select]<sup>1</sup>

NOTE<sup>1</sup> For SEAWAVE<sup>3</sup>, press [ENTER].

#### SW1101:

- [DATA] + "Route" + [ENTER] + "Select" + [ENTER] + use the cursor key to highlight the Route + [Select]

The Route, shown by straight segments, is centered on the screen, with the cursor on the central Waypoint. This will then allow you to quickly work out which Route you have selected.

When you want to create a new Route, select an open Route position in the list using the above procedure.

### Creating a Route

To create a new Route:

- Place the cursor + [ENTER] + "WAYPOINT" + [ENTER]

#### MARLIN:

- Place the cursor + [ROUTE]

This places the first Waypoint of the new Route on your cursor position. If a Mark is present under the cursor position, the Mark is linked to the Route. To place the next Waypoints of the Route repeat the above procedure.

The following functions work on the Active Route.

### Inserting notes on Route

To insert a comment on the selected Route:

- [MENU] + "Route" + [ENTER] + "Select" + [ENTER] + use the cursor key to highlight the Route + [Notes]<sup>1</sup>

NOTE<sup>1</sup> For SEAWAVE<sup>3</sup>, press [1, Notes].

#### SW1101:

- [DATA] + "Route" + [ENTER] + "Select" + [ENTER] + use the cursor key to highlight the Route + [Notes]

Another window is shown: use the cursor key to insert the notes (this is possible only if you have already created a Route). Press [ENTER] to confirm ([Cancel] otherwise).

### Hiding or Showing Route

To hide or show the selected Route on the screen:

- [MENU] + "Route" + [ENTER] + "Select" + [ENTER] + use the cursor key to highlight the Route + [Hide]<sup>1</sup>/[Show]<sup>1</sup>

NOTE<sup>1</sup> For SEAWAVE<sup>3</sup>, press [3, Hide]/[3, Show].

#### SW1101:

- [DATA] + "Route" + [ENTER] + "Select" + [ENTER] + use the cursor key to highlight the Route + [Hide]/[Show]

### Selecting Route Color

To select Route legs color among the eight available colors:

If in Route menu page:

- [MENU] + "Route" + [ENTER] + "Color" + [ENTER] + use the cursor key to select color + [ENTER]

#### SW1101:

- [DATA] + "Route" + [ENTER] + "Color" + [ENTER] + use the cursor key to select color + [ENTER]

If in Select Route menu:

- [MENU] + "Route" + [ENTER] + "Select" + [ENTER] + use the cursor key to highlight the Route + [Color]<sup>1</sup> + use the cursor key to select color + [ENTER]

NOTE<sup>1</sup> For SEAWAVE<sup>3</sup>, press [2, Color].

#### SW1101:

- [DATA] + "Route" + [ENTER] + "Select" + [ENTER] + use the cursor key to highlight the Route + [Color] + use the cursor key to select color + [ENTER]

The Route is drawn on the screen in the selected color. It is possible to select a different color for any Route.

### Deleting Route

If in Route menu:

- [MENU] + "Route" + [ENTER] + "Delete" + [ENTER] + [Accept]<sup>1</sup>

NOTE<sup>1</sup> For SEAWAVE<sup>3</sup>, press [1, Accept].

#### SW1101:

- [DATA] + "Route" + [ENTER] + "Delete" + [ENTER] + [Accept]

The Route legs and Waypoints are deleted. The Marks linked to the Route are not deleted. If the destination is placed on the Route, that Route cannot be deleted.

### Following a Route (Activate the Navigation)

With the Route shown on the Chart page, move the cursor to the starting Waypoint in the Route and press [ENTER], select "GOTO" and press [ENTER] again.

#### MARLIN/SEAWAVE<sup>3</sup>:

move the cursor to the starting Waypoint in the Route and press [GOTO].

The destination is placed on the Waypoint of the selected Route and you are now navigating to it.



## Inserting Waypoint

To insert a new Waypoint between two existing ones:

- Place the cursor on the desired Route leg + [Insert]<sup>1</sup> + move the cursor to the new position + [ENTER]<sup>1</sup>

NOTE<sup>1</sup> For SEAWAVE<sup>3</sup>, press [1, Insert] and [1, Accept].

The new Waypoint is placed.

To add a new Waypoint to the last Waypoint of the Route:

- Place the cursor + [ENTER] + "WAYPOINT" + [ENTER]

MARLIN:

- Place the cursor + [ROUTE]

## Reversing Route

To generate a new route reversing an existing one.

If in Route Data Report page:

- [MENU] + "Route" + [ENTER] + "Report" + [ENTER] + [Reverse]<sup>1</sup>

NOTE<sup>1</sup> For SEAWAVE<sup>3</sup>, press [3, Reverse].

SW1101:

- [DATA] + "Route" + [ENTER] + "Report" + [ENTER] + [Reverse]

The Route is then followed in reverse order, with Waypoints renumbered accordingly. If the destination is placed on the Route, that Route cannot be reversed.

## Selecting Route Report page

To give information on Waypoints belonging to the selected Route:

- [MENU] + "Route" + [ENTER] + "Report" + [ENTER]

SW1101:

- [DATA] + "Route" + [ENTER] + "Report" + [ENTER]

In this page it is possible to modify the Speed and Fuel consumption values:

- [MENU] + "Route" + [ENTER] + "Report" + [ENTER] + [Speed]<sup>1</sup>/[Fuel]<sup>1</sup> + use the cursor to insert values + [ENTER]

NOTE<sup>1</sup> For SEAWAVE<sup>3</sup>, press [1, Fuel]/[2, Speed].

SW1101:

- [DATA] + "Route" + [ENTER] + "Report" + [ENTER] + [Speed]/[Fuel] + use the cursor to insert values + [ENTER]

## Sending Route

To transmit the Active Route information onto the NMEA output port.

- [MENU] + "Route" + [ENTER] + "Send" + [ENTER]

SW1101:

- [DATA] + "Route" + [ENTER] + "Send" + [ENTER]

The NMEA WPL & RTE messages are sent to the output port.

## Receiving Route

To save Route information received from the NMEA input port.

- [MENU] + "Route" + [ENTER] + "Receive" + [ENTER]

SW1101:

- [DATA] + "Route" + [ENTER] + "Receive" + [ENTER]

The received route is saved on the Active route, overwriting it. The NMEA WPL & RTE messages are sent to the input port.

## Safe Route Checking

This function checks the presence of particular cartographic objects (see the list

below) on a range set by the user for all Route legs:

- ◆ Land Areas
- ◆ Shallow Water
- ◆ Intertidal Areas
- ◆ Rocks
- ◆ Wrecks
- ◆ Obstructions
- ◆ Shoreline Constructions
- ◆ Fishing Facility
- ◆ Dredged Areas
- ◆ Diffusers
- ◆ Mooring/Warping Facility
- ◆ Production Installation
- ◆ Pingos
- ◆ No Data Available

If any of these alarm conditions is detected, then the chart plotter highlights the list of dangerous objects and the correspondant dangerous Route leg. The Route leg is then drawn in a different color.

It is possible to make the Safe Route Check from menu following the procedure:

- [MENU] + "Route" + [ENTER] + "Route Check Report" + [ENTER]

**SW1101:**

- [DATA] + "Route" + [ENTER] + "Route Check Report" + [ENTER]

or:

- Place the cursor on the desired Route leg + [Check]<sup>1</sup>

**NOTE<sup>1</sup>** For SEAWAVE<sup>3</sup>, press [2, Check].

The list of the dangerous objects found on the charts crossed by the Route is shown in the Route check report.

It is also possible to activate this function in automatic mode:

- [MENU] + "Route" + [ENTER] + "Automatic Route Check" + [ENTER] + "On" + [ENTER]

**SW1101:**

- [DATA] + "Route" + [ENTER] + "Automatic Route Check" + [ENTER] + "On" + [ENTER]

If Automatic Route Check is activated, the modified Route legs are checked everytime a Waypoint is added, inserted, edited or moved.

Before activating the function, you could change the function parameters, as the width and the depth of the detected area and the research accuracy.

To select the width of the detected area aside the Route:

- [MENU] + "Route" + [ENTER] + "Route Width" + [ENTER] + insert the desired value + [ENTER]

**SW1101:**

- [DATA] + "Route" + [ENTER] + "Route Width" + [ENTER] + insert the desired value + [ENTER]

**NOTE** Safe Route width value represents half the total width checked by the function.

To select the depth of the detected area aside the Route:

- [MENU] + "Route" + [ENTER] + "Route Depth" + [ENTER] + insert the desired value + [ENTER]

### SW1101:

- [DATA] + "Route" + [ENTER] + "Route Depth" + [ENTER] + insert the desired value + [ENTER]

It also possible to select the accuracy for the Route check, among Minimum, Low, Medium, High and Maximum:

- [MENU] + "Route" + [ENTER] + "Route Check Accuracy" + [ENTER]

### SW1101:

- [DATA] + "Route" + [ENTER] + "Route Check Accuracy" + [ENTER]

## 2.3 GOTO FUNCTION

This functions allows you to place the destination point and immediately start navigating to it.

### Navigation to Waypoint

- Place the cursor on the desired Waypoint + [ENTER] + "Go To" + [ENTER]
- or simply:
- Place the cursor on the desired Waypoint + [Go To]

### MARLIN/SEAWAVE<sup>3</sup>:

- Place the cursor on the desired Waypoint + [GOTO]

A circle surrounds the Waypoint symbol. A dotted line is shown, connecting the destination with the ship's position. When the destination is placed, all navigation data are referred to it.

### Deleting destination

If the destination has been placed, to stop the navigation to the Waypoint:

- Place the cursor on destination icon + [Stop]<sup>1</sup>

**NOTE** *If you press [Next]/[Prev.] (or press [2, Next]/[3, Prev.] for SEAWAVE<sup>3</sup>) the destination icon is moved on the next/previous Waypoint in the Route.*

Otherwise when the cursor is placed on a generic position on the chart:

- [ENTER] + "Go To" + [ENTER] + [Stop]<sup>1</sup>

**NOTE** *If you press [Start] (or press [2, Start] for SEAWAVE<sup>3</sup>), the destination icon is moved on the new cursor position.*

The symbol that identifies the destination disappears from the screen, but the Waypoint remains.

**NOTE<sup>1</sup>** *For SEAWAVE<sup>2</sup>, press [1, Stop].*

## 2.4 USING TRACK

A very useful feature of the chart plotter, is the ability to store and display exactly where the boat has been. This feature, referred to as Tracking, can provide invaluable information about the effect of tide and wind influence on the boat's progress as well as giving an indication of the helmsman's performance.

When full storing capacity has been reached, the oldest points are deleted and overwritten by the newest ones.

### Setting up a Track Step

Before you use the Track function, it is important to specify the Track step unit: if you select Distance, the Track point is placed when the distance from its last stored position is greater than the defined distance; if Time, the Track point is placed after the defined time.

- [MENU] + "Track" + [ENTER] + "Config" + [ENTER] + "Step Unit" + [ENTER]

SW1101:

- [DATA] + "Track" + [ENTER] + "Config" + [ENTER] + "Step Unit" + [ENTER]

MARLIN/SEAWAVE<sup>3</sup>:

- [TRACK] + "Config" + [ENTER] + "Step Unit" + [ENTER]

You can select the Track step Time [1, 5, 10, 30 sec, 1 min] or distance [0.01, 0.05, 0.1, 0.5, 1.0, 2.0, 5.0, 10.0] Nm. Setting a short time/distance interval between Track points is best suited to navigate within a close or complex environment, a greater time/distance interval is best suited to a long voyage.

To select the interval at which the Track points are placed.

If you have selected Distance:

- [MENU] + "Track" + [ENTER] + "Config" + [ENTER] + "Distance Step" + [ENTER]

SW1101:

- [DATA] + "Track" + [ENTER] + "Config" + [ENTER] + "Distance Step" + [ENTER]

MARLIN/SEAWAVE<sup>3</sup>:

- [TRACK] + "Config" + [ENTER] + "Distance Step" + [ENTER]

If you have selected Time:

- [MENU] + "Track" + [ENTER] + "Config" + [ENTER] + "Time Step" + [ENTER]

SW1101:

- [DATA] + "Track" + [ENTER] + "Config" + [ENTER] + "Time Step" + [ENTER]

MARLIN/SEAWAVE<sup>3</sup>:

- [TRACK] + "Config" + [ENTER] + "Time Step" + [ENTER]

## Selecting Track Color

You can select 8 different line colors that you choose for the Track:

- [MENU] + "Track" + [ENTER] + "Config" + [ENTER] + "Color" + [ENTER]

SW1101:

- [DATA] + "Track" + [ENTER] + "Config" + [ENTER] + "Color" + [ENTER]

MARLIN/SEAWAVE<sup>3</sup>:

- [TRACK] + "Config" + [ENTER] + "Color" + [ENTER]

The same Track can be saved with any color.

## Displaying Track

To enable or disable the Track displaying on the map screen:

- [MENU] + "Track" + [ENTER] + "Config" + [ENTER] + "Display Mode" + [ENTER] + "Visible"/"Hidden" + [ENTER]

SW1101:

- [DATA] + "Track" + [ENTER] + "Config" + [ENTER] + "Display Mode" + [ENTER] + "Visible"/"Hidden" + [ENTER]

MARLIN/SEAWAVE<sup>3</sup>:

- [TRACK] + "Config" + [ENTER] + "Display Mode" + [ENTER] + "Visible"/"Hidden" + [ENTER]

## Activating/Deactivating Track Recording

To activate or deactivate the Tracking of the vessel while the vessel is moving:

- [MENU] + "Track" + [ENTER] + "Activate"/"Deactivate" + [ENTER]

SW1101:

- [DATA] + "Track" + [ENTER] + "Activate"/"Deactivate" + [ENTER]

MARLIN/SEAWAVE<sup>3</sup>:

- [TRACK] + "Activate"/"Deactivate" + [ENTER]

## Clearing Track

All the Track or part of it can be cleared from the screen:

- [MENU] + "Track" + [ENTER] + "Delete" + [ENTER]

SW1101:

- [DATA] + "Track" + [ENTER] + "Delete" + [ENTER]

MARLIN/SEAWAVE<sup>3</sup>:

- [TRACK] + "Delete" + [ENTER]

[Begin]<sup>1</sup>, [End]<sup>1</sup> and [Whole]<sup>1</sup> allow to identify the start or the end point of the segment to delete.

NOTE<sup>1</sup> For SEAWAVE<sup>3</sup>, press [1, Begin], [2, End] and [3, Whole].

## Selecting Track Number

The chart plotter has the capability to store up to 5 Tracks. To select a Track:

- [MENU] + "Track" + [ENTER] + "Config" + [ENTER] + "Active Track" + [ENTER] + use the cursor key to select the number + [ENTER]

SW1101:

- [DATA] + "Track" + [ENTER] + "Config" + [ENTER] + "Active Track" + [ENTER] + use the cursor key to select the number + [ENTER]

MARLIN/SEAWAVE<sup>3</sup>:

- [TRACK] + "Config" + [ENTER] + "Active Track" + [ENTER] + use the cursor key to select the number + [ENTER]

## TRACK TO ROUTE FUNCTION

This function creates a Route from a pre-recorded Track. To select this menu:

- [MENU] + "Track" + [ENTER] + "Track To Route" + [ENTER]

SW1101:

- [DATA] + "Track" + [ENTER] + "Track To Route" + [ENTER]

MARLIN/SEAWAVE<sup>3</sup>:

- [TRACK] + "Track To Route" + [ENTER]

A new window appears on the screen with the following options.

## Track To Route

Executes the function that converts the given Track into a Route.

- [MENU] + "Track" + [ENTER] + "Track To Route" + [ENTER] + "Track To Route" + [ENTER]

SW1101:

- [DATA] + "Track" + [ENTER] + "Track To Route" + [ENTER] + "Track To Route" + [ENTER]

MARLIN/SEAWAVE<sup>3</sup>:

- [TRACK] + "Track To Route" + [ENTER] + "Track To Route" + [ENTER]

## Select Track Number

Selects the Track input number:

- [MENU] + "Track" + [ENTER] + "Track To Route" + [ENTER] + "Select Track No." + [ENTER]

SW1101:

- [DATA] + "Track" + [ENTER] + "Track To Route" + [ENTER] + "Select Track No." + [ENTER]

MARLIN/SEAWAVE<sup>3</sup>:

- [TRACK] + "Track To Route" + [ENTER] + "Select Track No." + [ENTER]

## Select Route Number

Selects the Route output number:

- [MENU] + "Track" + [ENTER] + "Track To Route" + [ENTER] + "Select Route No." + [ENTER]

SW1101:

- [DATA] + "Track" + [ENTER] + "Track To Route" + [ENTER] + "Select Route No." + [ENTER]

MARLIN/SEAWAVE<sup>3</sup>:

- [TRACK] + "Track To Route" + [ENTER] + "Select Route No." + [ENTER]

## 2.5 DATA WINDOW CUSTOMIZATION ON CHART PAGE

It is possible to customize the Text Area layout among a Text Area with a variable number of boxes (the number depending on the chart plotter type):

- [MENU] + "Display Options" + [ENTER] + "Data Window Mode" + [ENTER]

It is also possible to edit fields shown in every screen configuration. Edit mode is activated directly from the chart display following the procedure:

- [MENU] hold for 3 seconds + use the cursor key to select data window to customize + [ENTER] + use the cursor key to choose selection + [ENTER]

Once [ENTER] is pressed the data type is set. The selection window is closed and the Text Area changes according to the selected data type. Press [CLEAR] to exit the edit mode.

## 2.6 INFO

Placing the cursor on cartographic objects the information related to the object nearby is shown.

### Setting Automatic Info

Automatic Info allows you to get the information on any cartographic object just by placing the cursor on it. You can select the type of it:

- [MENU] + "Display Options" + [ENTER] + "Auto Info" + [ENTER]

The possible settings are **Off** (no automatic info shown at all), **On Points** (only on points e.g. Rocks, Buoys, Lights, Tide Stations) and **On All** (on all objects, points, lines and areas).

**NOTE** *Choosing "On All" the Automatic Info will be shown most of the times the cursor is moved.*

### Selecting Automatic Info

- Move the cursor on the object

The pop-up window with the basic info of the objects is displayed. To get full details of the object press [Expand]<sup>1</sup>.

**NOTE**<sup>1</sup> *For SEAWAVE<sup>3</sup>, press [1, Expand].*

### Displaying Expanded Info page (Full Info)

To show the Expanded Info page:

- Place the cursor on objects + [ENTER] + "Info" + [ENTER]

MARLIN:

- Place the cursor on objects + [INFO]

### Info on objects with Pictures

To get the information on objects with pictures:

- Move the cursor on the object

On the Quick Info, if at least one of the objects found has one or more pictures

associated, there is a camera icon:



Fig. 2.6 - Example of Quick Info on objects with picture

Press **[Expand]**<sup>1</sup> to see the Full Info page, there is the small camera icon on a corner of the square containing the object icon (or a big photo icon centered on the square for the object without icon):

**NOTE**<sup>1</sup> For SEAWAVE<sup>3</sup>, press [1, Expand].

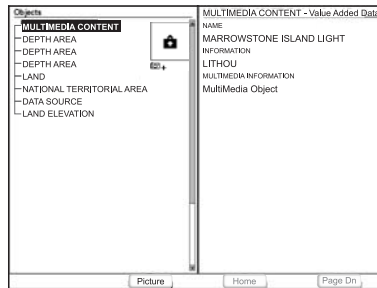

Fig. 2.6a - Example of Full Info on objects window with picture icon

To see pictures:

- Press **[Picture]**<sup>1</sup> when the object with a picture is highlighted

**NOTE**<sup>1</sup> For SEAWAVE<sup>3</sup>, press [1, Picture].



Fig. 2.6b - Example of picture

To change picture size:

- Press **[ENTER]** when the picture is shown

## Info Tree and Expanded Info page

The upper side of the page contains the Info Tree and the Lower side contains the expanded information. While moving the cursor through the Info Tree, all the relevant information of the selected object is shown on the lower part of the page. By pressing **[CLEAR]** the page is closed. If the information shown on the Lower part of the page exceeds the page size, you may scroll the page using **[Page Dn]**<sup>1</sup>. Use **[Home]**<sup>1</sup> to get back to the first page. When the selected object is a Tide Station, by pressing **[ENTER]** the Tide page is shown.

**NOTE**<sup>1</sup> For SEAWAVE<sup>3</sup>, press [4, Page Dn] and [3, Home].

## Quick Info on Lakes

Upon viewing the chart of a lake, you will click on to query the available information immediately displayed with many details. For example, see the following picture:

Lakes Info icon

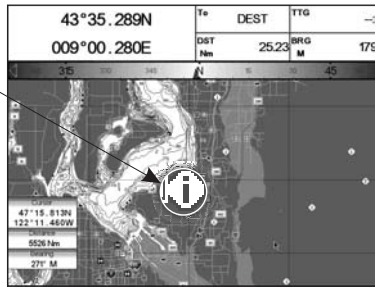

Fig. 2.6c - Example of Lakes info

When the cursor is placed over the icon, the icons of the available services are shown:



Fig. 2.6d - Quick Info: available services

If you press **[Expand]**<sup>1</sup> all available information about the cartographic point under the cursor will be shown. See the next paragraph.

**NOTE**<sup>1</sup> For SEAWAVE<sup>3</sup>, press [1, Expand].

## Full Info on Lakes

The following is an example of Full Info on Lakes:



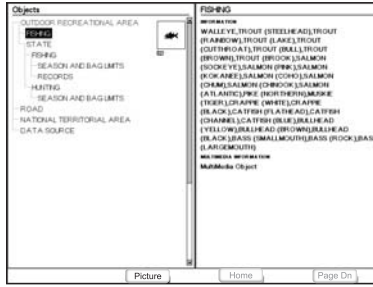

Fig. 2.6e - Example of Full Info page

To see the "Fishing" object press **[Picture]**<sup>1</sup> (when the "Fishing" object is high-lighted). On the screen appears:

**NOTE**<sup>1</sup> For SEAWAVE<sup>3</sup>, press [1, Picture].

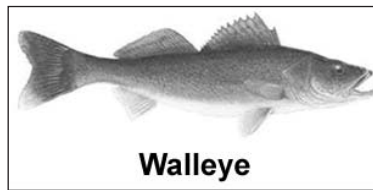

Fig. 2.6f - Example of picture associated to the Fishing object

## 2.7 PORT & TIDE INFO

### Getting Port Info

The object Port Marina contains the information about the services available on the selected Port Marina and the area around it. To get info on Port Marinas, move the cursor on the Port Info icon.

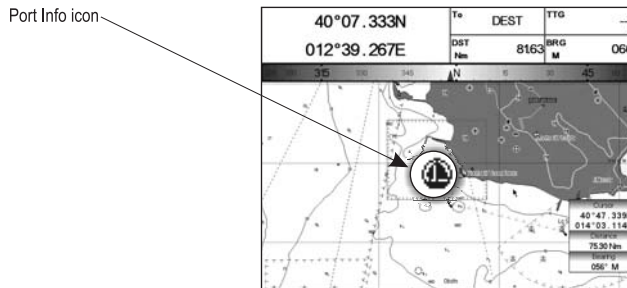

Fig.2.7 - Port Info icon

The available information is shown in the Automatic Info window where icons of the available services are shown. To expand information about that object press **[Expand]**<sup>1</sup> and to expand all available information and get the details on each service of the Port Marina for that cartographic point press **[Exp All]**<sup>1</sup>.

**NOTE**<sup>1</sup> For SEAWAVE<sup>3</sup>, press [1, Expand] and [2, Exp All].

**NOTE** Port Info icon is visible only if the Ports & Services option is On (see Par. 4.1).

## Getting Tide Info

Tide Info icon

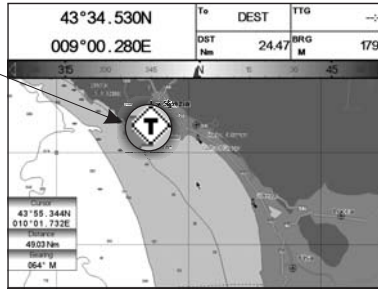

Fig. 2.7a - Tide Info icon

By placing the cursor over the Tide Station icon the chart plotter pops-up the relative automatic info window and allows displaying a graphical page with the tides prediction of the selected object. Press **[Expand]**<sup>1</sup> :

**NOTE**<sup>1</sup> For SEAWAVE<sup>3</sup>, press [1, Expand].

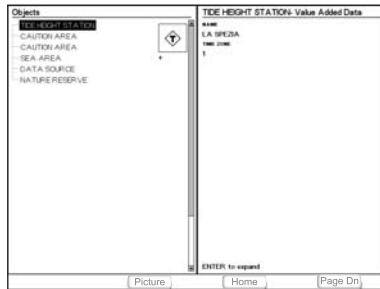

Fig. 2.7b - Tide information page

Press **[ENTER]** to display the Tide Graph page. It shows the Tide height variations during the 24 hours at any given day.

Values referred to the VERTICAL cursor

Values referred to the HORIZONTAL cursor

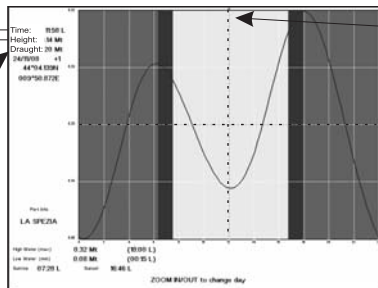

Fig. 2.7c - Tide Graph page

This screen shows that day's Tide Height graph for the area where the Tidal symbol was located. Using **[ZOOM IN]** and **[ZOOM OUT]** it is possible to display future or past tides. If you wish to quickly display the tide for a specific date, press **[ENTER]** and enter the required date. To simplify reading the graph, the chart plotter displays a moveable Vertical and Horizontal slider which can be moved using the cursor key. Using the up/down cursor key, move the horizontal slider to

correspond with the draft of your boat. Using the Vertical slider you can then read the times at which the graph dips below the horizontal line i.e. the times when you will be in danger of grounding.

**NOTE** *Tide graph is an approximation of the tide and they should be used in conjunction with traditional tide tables and navigational methods. The Tide height value represents the variation relative to the "Mean Lower Water" value.*

## 2.8 FIND FUNCTION

The Find function allows searching for the nearest Port, Port Services, Tide Stations, Wrecks, Obstructions, Points Of Interest and Lakes loaded on the DATA MEDIA. When the Find function is activated a list of available objects to search is shown. Also the Find function allows to center the screen over a selected User Point, on the Cursor position or at desired Coordinates.

**NOTE** *Activating the Find function a Warning message is shown if there is no DATA MEDIA inserted.*

### Finding Nearest Port Services

To show the nearest port services of a particular type (i.e. the nearest Hospital, sailmaker, bank, etc.).

➤ **[ENTER] + "Find" + [ENTER] + "Port Services" + [ENTER]**

The icons list of the available services is shown. Use the cursor key to select any facility and press **[ENTER]** or **[Find]**<sup>1</sup>. By selecting one of the facilities the list of the nearest ports (up to 10) in which this port facility is present, will be shown.

**NOTE**<sup>1</sup> *For SEAWAVE<sup>2</sup>, press [1, Find].*

### Finding Nearest Port By Name

To select the Port By Name function:

➤ **[ENTER] + "Find" + [ENTER] + "Port by Name" + [ENTER]**

Shows the list of all ports stored on the DATA MEDIA in alphabetical order and allows to search port by name to locate the port on the map.

### Finding Nearest Port By Distance

To select the Port By Distance function:

➤ **[ENTER] + "Find" + [ENTER] + "Port by Distance" + [ENTER]**

Shows the list of all ports stored on the DATA MEDIA in closest distance order and allows to locate the port on the map.

### Finding Nearest Tide Station

To show the nearest Tide Stations to the boat position (or to the cursor position if the position fix is not received).

➤ **[ENTER] + "Find" + [ENTER] + "Tide Stations" + [ENTER]**

After a few seconds a window appears. Choose the Tide Station you want and press **[ENTER]** or **[Find]**<sup>1</sup> to display the Tide Graph page. Press **[CLEAR]** to display the Tide Station chosen.

**NOTE**<sup>1</sup> *For SEAWAVE<sup>2</sup>, press [1, Find].*

### Finding Nearest Wrecks

To show the Nearest Wrecks loaded in the DATA MEDIA:

➤ **[ENTER] + "Find" + [ENTER] + "Wrecks" + [ENTER]**

Choose the Wrecks you prefer and press **[ENTER]** or **[Find]**<sup>1</sup> to locate the selected Wreck on the map.

**NOTE**<sup>1</sup> *For SEAWAVE<sup>2</sup>, press [1, Find].*

## Finding Nearest Obstructions

To show the Nearest Obstructions loaded in the DATA MEDIA:

- [ENTER] + "Find" + [ENTER] + "Obstructions" + [ENTER]

Choose the Obstructions you prefer and press [ENTER] or [Find]<sup>1</sup> to locate the selected Obstruction on the map.

**NOTE<sup>1</sup>** For SEAWAVE<sup>3</sup>, press [1, Find].

## Finding Nearest Lakes Information

Searches for Nearest Lakes Info:

- [ENTER] + "Find" + [ENTER] + "Lakes Info" + [ENTER]

This function is used to found the Outdoor Recreational Area objects (see the left side of the following Fig. 2.8). Use the cursor key to select any objects and press [ENTER]. The list of the nearest lakes containing the facility will be shown on the screen (see the right side of the following Fig. 2.8):

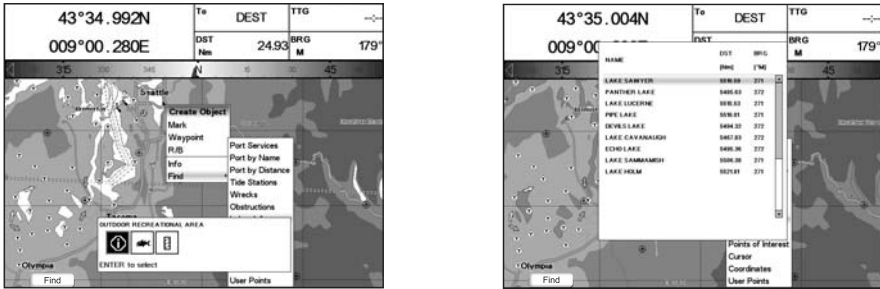

Fig. 2.8 - Outdoor Recreational Area objects (left) and nearest Lakes list (right)

Then choose the lake you want and press [ENTER]: the Full Info page is shown.

## Finding Nearest Lakes By Name

To select the lakes By Name function:

- [ENTER] + "Find" + [ENTER] + "Lakes by Name" + [ENTER]

Shows the list of all lakes stored on the DATA MEDIA in alphabetic order. Pressing [MENU] to insert the Lake name.

## Finding Nearest Points Of Interest

Searches for nearest Points Of Interest:

- [ENTER] + "Find" + [ENTER] + "Points Of Interest" + [ENTER]

A sub-menu is opened to find different categories of Points Of Interest.

## Finding Cursor

To center the cursor on the screen:

- [ENTER] + "Find" + [ENTER] + "Cursor" + [ENTER]

## Finding Coordinates

To center the map at given coordinates:

- [ENTER] + "Find" + [ENTER] + "Coordinates" + [ENTER] + use the cursor to insert coordinates + [CLEAR]

## Finding User Points

To search the User Point by name:

- [ENTER] + "Find" + [ENTER] + "User Points" + [ENTER] + use the cursor to insert name of the Waypoint to show on map + [ENTER]

## 2.9 ALARMS

The chart plotter provides alarms for various functions. You can enter the desired alarm range for each function.

### Auto Off

To set the automatic shutdown of the alarms when the alarm condition disappears.

- [MENU] + "Alarms" + [ENTER] + "Auto Off" + [ENTER]

SW1101:

- [DATA] + "Alarms" + [ENTER] + "Auto Off" + [ENTER]

### Arrival Alarm

To set an acoustic alarm to sound when the vessel is approaching the destination.

- [MENU] + "Alarms" + [ENTER] + "Arrival Alarm" + [ENTER]

SW1101:

- [DATA] + "Alarms" + [ENTER] + "Arrival Alarm" + [ENTER]

### XTE Alarm

To set an acoustic alarm to sound when the vessel is deviating from a defined course.

- [MENU] + "Alarms" + [ENTER] + "XTE Alarm" + [ENTER]

SW1101:

- [DATA] + "Alarms" + [ENTER] + "XTE Alarm" + [ENTER]

### Anchor Alarm

To set an alarm to sound when the ship moves off the current ship's position location.

- [MENU] + "Alarms" + [ENTER] + "Anchor Alarm" + [ENTER]

SW1101:

- [DATA] + "Alarms" + [ENTER] + "Anchor Alarm" + [ENTER]

**NOTE** *By the time the Anchor Alarm is set the current ship's position is saved as origin position. The alarm goes off when the ship moves away from the origin position more than the entered alarm range.*

### Depth Alarm

This function is used to set an acoustic alarm automatically triggered when the depth value read by the depth transducer is too shallow.

- [MENU] + "Alarms" + [ENTER] + "Depth Alarm" + [ENTER]

SW1101:

- [DATA] + "Alarms" + [ENTER] + "Depth Alarm" + [ENTER]

### HDOP Alarm

This function is used to show a warning when the received HDOP value exceeds the Alarm Limit for more than 2 seconds. The default setting is 4 seconds. To activate the HDOP Alarm:

- [MENU] + "Alarms" + [ENTER] + "HDOP Alarm" + [ENTER]

SW1101:

- [DATA] + "Alarms" + [ENTER] + "HDOP Alarm" + [ENTER]

### Heading Alarm

This function is used to show a warning when the HDG sentence is not received from a magnetic sensor reading.

- [MENU] + "Alarms" + [ENTER] + "Heading Alarm" + [ENTER]

**SW1101:**

- [DATA] + "Alarms" + [ENTER] + "Heading Alarm" + [ENTER]

**MARLIN/SEAWAVE<sup>3</sup>:**

### Timer Alarm

The Timer Alarm is activated when the defined time is expired. Stops (Off) the Timer Alarm counter or enter the Timer value (Hours Minutes Seconds Range 00:00:01 - 23:59:59).

- [MENU] + "Alarms" + [ENTER] + "Timer Alarm" + [ENTER]

**MARLIN/SEAWAVE<sup>3</sup>:**

### Timer Direction

Set the Timer Direction UP or DOWN: when Timer Direction is set UP, the timer start from zero and increases its value; the alarm is activated when the timer reaches the Timer Value entered by the user. When Timer Direction is set DOWN, the count-down starts from the value set by the user and decreases its value. The Alarm is activated when the Timer value goes to zero.

- [MENU] + "Alarms" + [ENTER] + "Timer Direction" + [ENTER]

### Grounding Alarm

To verify potential danger to navigation such as shallow water (depth areas), intertidal areas, land, rocks, obstructions and shoreline constructions. The maps are scanned every 10 seconds.

If any of the above objects are found, the chart plotter notifies the danger on a dedicated warning message box. The active "Grounding Alarms" are shown in the Grounding Alarm Report page. To activate the Grounding Alarm:

- [MENU] + "Alarms" + [ENTER] + "Grounding Alarm" + [ENTER]

**SW1101:**

- [DATA] + "Alarms" + [ENTER] + "Grounding Alarm" + [ENTER]

The chart plotter scans a sector in front of the boat. The direction is determined by the current boat heading. You can select the length and its angle is 30 degrees. The Grounding Alarm is switched Off by default after a Master Reset.

### Grounding Alarm Range

To set the length of the sector to be detected among 0.25, 0.5, 1.0 Nm.

- [MENU] + "Alarms" + [ENTER] + "Grounding Alarm Range" + [ENTER]

**SW1101:**

- [DATA] + "Alarms" + [ENTER] + "Grounding Alarm Range" + [ENTER]

### Grounding Alarm Report

To display the report of the dangerous objects currently detected.

- [MENU] + "Alarms" + [ENTER] + "Grounding Alarm Report" + [ENTER]

**SW1101:**

- [DATA] + "Alarms" + [ENTER] + "Grounding Alarm Report" + [ENTER]

When any of the searched objects is found in the scanned area, a tick marker is printed on the relative box to identify which dangerous objects have been currently detected. Once the alarm condition is no longer present, the relative tick marker is removed.

**NOTE** *The alarm "No data available" is shown when no specific cartographic data are found on the DATA MEDIA or when no DATA MEDIA is inserted.*

## SW701e/SW701i/SW701ce/SW701ci/SW1101/MARLIN/SEAWAVE<sup>3</sup>/EXPLORER<sup>3</sup>:

### External Alarm

When any alarm condition occurs the pin is switched from High Impedance to ground. This signal can be used by an external device (as a hooter or buzzer).

- [MENU] + "Alarms" + [ENTER] + "External Alarm" + [ENTER]

### SW1101:

- [DATA] + "Alarms" + [ENTER] + "External Alarm" + [ENTER]

## 2.10 USER MEDIA: SAVE & LOAD MENU

The chart plotter allows to back up Marks, Routes and Tracks to a USER MEDIA. You can also restore the data to internal memory at a later time. This allows virtually unlimited storage. The USER MEDIA data storage is organized as a file system.

### USER MEDIA page

To display the content of a USER MEDIA inserted into the MEDIA slot of your chart plotter:

- [MENU] + "Save & Load" + [ENTER]

### SW1101:

- [DATA] + "Save & Load" + [ENTER]

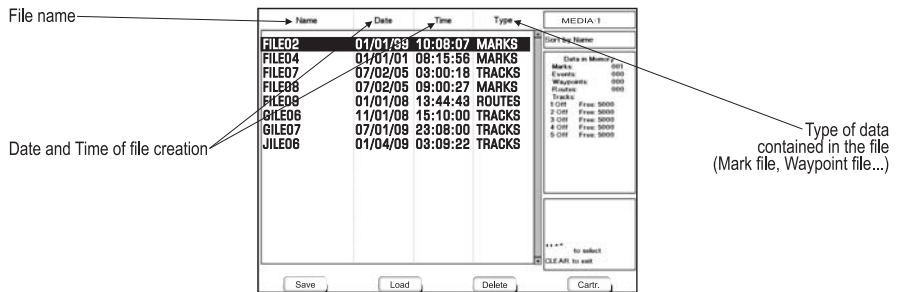

Fig. 2.10 - Example of USER MEDIA Menu

### Formatting USER MEDIA

In order to be able to use a new USER MEDIA you must format it first. This operation prepares the USER MEDIA to receive and store information:

- [MENU] + "Save & Load" + [ENTER] + [Media]<sup>1</sup> + [Format]<sup>1</sup>

NOTE<sup>1</sup> For SEAWAVE<sup>3</sup>, press [4, SD-Card] and [3, Format].

### SW1101:

- [DATA] + "Save & Load" + [ENTER] + [Media] + [Format]

NOTE When a USER MEDIA is formatted, all data saved on it will be deleted.

### Saving File on USER MEDIA

- [MENU] + "Save & Load" + [ENTER] + [Save]<sup>1</sup> + select the file type to be added by using related soft key + insert the file name and type + [ENTER]

NOTE<sup>1</sup> For SEAWAVE<sup>3</sup>, press [1, Save].

### SW1101:

- [DATA] + "Save & Load" + [ENTER] + [Save] + select the file type to be added by using related soft key + insert the file name and type + [ENTER]

When a certain type of data (Mark, Events, Route, Track) is saved, a new file is created on a USER MEDIA. The file contains all points of the selected type currently stored in the internal memory.

- ◆ Save Marks : to create a new file containing all Marks stored in the chart plotter
- ◆ Save Events: to create a new file containing all Events stored in the chart plotter
- ◆ Save Routes: to create a new file containing all Waypoints belonging to the selected Route (Route number is required)
- ◆ Save Tracks : to create a new file containing all Track points belonging to the selected Track (Track number is required)

**NOTE** *When naming a file, you may have trouble finding a name that uniquely identifies the file's contents. Dates, for example, are often used in filenames; however, they take up several characters, leaving you with little flexibility. The secret is to find a compromise, a point where you can combine a date with a word, creating a unique filename. The maximum length of the filename is 8 characters. The characters may be numbers (0, ..., 9), letters (A, ..., Z) and spaces (for example legal identifiers are "ABC", "AA", "12121212", "A B C", "1 A 1", and so on.*

## Loading File from USER MEDIA

- [MENU] + "Save & Load" + [ENTER] + Select the file name in the list + [Load]<sup>1</sup>

**NOTE**<sup>1</sup> *For SEAWAVE<sup>3</sup>, press [2, Load].*

**SW1101:**

- [DATA] + "Save & Load" + [ENTER] + Select the file name in the list + [Load]

The Load function copies the content of the selected file from USER MEDIA to the internal memory of the chart plotter. If the selected file contains Marks/Events already present in the chart plotter memory, they are non duplicated. It is required to insert the number of the Route/Track on which loading data: if the Route/Track is not empty, it is overwritten.

## Deleting File from USER MEDIA

To remove files.

- [MENU] + "Save & Load" + [ENTER] + [Delete]<sup>1</sup>

**NOTE**<sup>1</sup> *For SEAWAVE<sup>3</sup>, press [3, Delete].*

**SW1101:**

- [DATA] + "Save & Load" + [ENTER] + [Delete]

**NOTE** *Remember that this option permanently erases the file.*

**MARLIN/SEAWAVE<sup>3</sup>:**

## Selecting Slot

To select the preferred slot where to insert the USER MEDIA. If the User USER MEDIA is not present in the selected slot, a warning message appears.

- [MENU] + "Save & Load" + [ENTER] + [Media]<sup>1</sup> + [Slot]<sup>1</sup>

**NOTE**<sup>1</sup> *For SEAWAVE<sup>3</sup>, press [4, SD-card] and [2, Slot].*

## Reading USER MEDIA directory

To show the list of the files present on the USER MEDIA inserted into the slot:

- [MENU] + "Save & Load" + [ENTER] + [Media]<sup>1</sup> + [Read]<sup>1</sup>

**NOTE**<sup>1</sup> *For SEAWAVE<sup>3</sup>, press [4, SD-card] and [1, Read].*

**SW1101:**

- [DATA] + "Save & Load" + [ENTER] + [Media] + [Read]



## Sorting USER MEDIA directory

To order the file directory:

- [MENU] + "Save & Load" + [ENTER] + [Media]<sup>1</sup> + [Sort By]<sup>1</sup>

**NOTE<sup>1</sup>** For SEAWAVE<sup>2</sup>, press [4, SD-card] and [3, Sort By].

### SW1101:

- [DATA] + "Save & Load" + [ENTER] + [Media] + [Sort By]

This is possible in three different modes:

- ◆ Name : to order by the filename press [Name]<sup>1</sup>
- ◆ Time : to order by the time of file creation press [Time]<sup>1</sup>
- ◆ Type : to order by the type of data press [Type]<sup>1</sup>

**NOTE<sup>1</sup>** For SEAWAVE<sup>2</sup>, press [1, Name], [2, Time] or [3, Type].



# 3. User Setting Up

---

## 3.1 GENERAL OPTIONS MENU

To set the general settings:

➤ [MENU] + "General Options" + [ENTER]

The possible selections are listed in the table below:

<b>Language</b>	: Selects the language for screen labels, menus and options; the map information remain on the language as in the official paper charts .
<b>Chart Language</b>	: Selects a sub-menu with two items: <b>Language</b> to set the language to display chart information and <b>Mode</b> to define how objects are translated.
<b>Distance Units</b>	: Selects the unit for Distance among Nm, Sm, Km.
<b>Speed Units</b>	: Selects the unit for Speed among Kts, Mph, Kph.
<b>Wind Units</b>	: Selects the unit for Wind among Kts, Kph, Mph, m/s, Bft.
<b>Depth Units</b>	: Selects the unit among Ft, FM and Mt.
<b>Altitude Units</b>	: Selects the unit among Ft, FL and Mt.
<b>Temperature Units</b>	: Selects the unit among °C and °F.
<b>Time Reference</b>	: Allows switching between UTC or local time, by entering the Local Time offset.
<b>Daylight Saving Time</b>	: Sets On/Off the Daylight Saving Time.
<b>Time Format</b>	: Selects the format for the time between 12 and 24 hours.
<b>Date Format</b>	: Selects the Date Format between MM-DD-YY (month-day-year) and DD-MM-YY (day-month-year).
<b>Nav-Aids Presentation</b>	: Allows to set the Nav Aids presentation as US (Draw Nav-Aids using NOAA symbology) or INTERNATIONAL (Draws Nav-Aids using international symbology). When selected it affects Lights, Signals, Buoys & Beacons display.
<b>Keypad Beep</b>	: Enables or disables the single audio beeps emitted any time the chart plotter keypad is pressed. If the incorrect key is pressed or the function required cannot be executed, the chart plotter emits three beeps.
<b>Cursor Speed</b>	: Selects the Cursor Speed among Low, Medium or High in Chart page or into menu.

## 3.2 MAP OPTIONS MENU

### Zoom Type

➤ [MENU] + "Map Options" + [ENTER] + "Zoom Type" + [ENTER]

Allows larger expansion or compression of the chart scale while zooming in or out. Zoom Type has two options; Standard (default) or Flexi-Zoom. When in Flexi-Zoom mode, a short [ZOOM...] push causes a change of chart, whilst a long [ZOOM...] push (press and hold) causes a pop-up window to be displayed on a corner of the screen. The window shows the current Zoom Factor. By pressing [ZOOM IN]/[ZOOM OUT] the map is expanded or compressed according to the zoom factor selected. The Window is automatically closed if [ZOOM...] is not pressed for 2 seconds and the selected zoom factor will be used at the next zoom in/out.

### Fonts & Symbols

➤ [MENU] + "Map Options" + [ENTER] + "Fonts & Symbols" + [ENTER]

It is possible to set the size of all names and symbols drawn on the charts, selecting between Normal size (the regular characters size) and Large size.

## NORMAL size

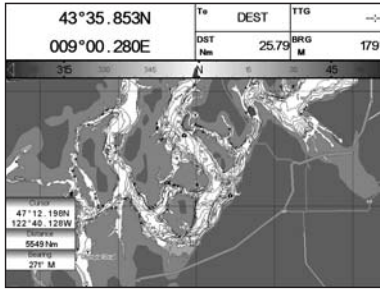

## LARGE size

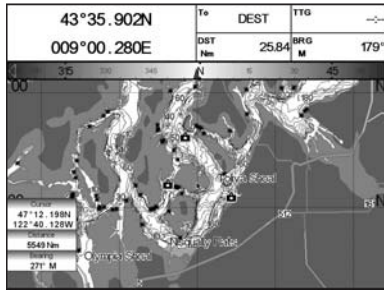

Fig. 3.2 - Example of Normal size font (on the left side) and Large size font (on the right side) settings

## Perspective View

► [MENU] + "Map Options" + [ENTER] + "Perspective View" + [ENTER]

Chart data may be projected in perspective mode during navigation. This function allows setting the panoramic view of the chart. As the upper side of the map is more compressed than the lower side, a wider map area is visible. The perspective view allows showing more chart information immediately ahead and around the cursor.

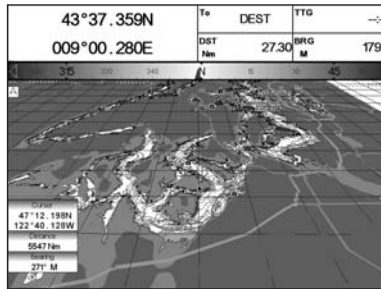

Fig. 3.2a - Perspective View

## Dynamic Nav-Aids

► [MENU] + "Map Options" + [ENTER] + "Dynamic Nav-Aids" + [ENTER]

This function allows settings blinking lights on Nav-Aids. The blinking period and color of each Nav-aid is read from the Nav-Aid attributes available on the data cartridge. When the ship is inside the Nav-Aid nominal range, the light of the Nav-Aid will start blinking.

**NOTE** When Dynamic Nav-Aids option is set to On, when the flashing light is Off, or when fix position is out of the sector, the light color is displayed by using a faint light color.

## Map Orientation

► [MENU] + "Map Options" + [ENTER] + "Map Orientation" + [ENTER]

The possible choices are listed in the table below:

<b>North Up</b>	: The map is shown with North upwards.
<b>Head Up</b>	: The map is shown with the ship's current heading upwards. If Head Up is selected, it is possible to set the Map Orientation Resolution angle in the range [5, 60] degrees.
<b>Track Up</b>	: The map is shown with the currently selected course leg upwards. If Track Up is selected, it is possible to set the Map Orientation Resolution angle in the range [5, 60] degrees.



- U. Zoom: red when the chart is under-zoomed out more than twice normal scale, gray otherwise.
- O. Zoom: red when the chart is over-zoomed in more than twice normal scale, gray otherwise.
- C. Lock: red when the chart is zoomed in more than twice normal scale, gray otherwise.

## 2 Best Map

Red when a more detailed chart is available under the cursor position.

## 3 Data Off

Red when at least one of the following objects or layers is turned off (by the user): Depths/soundings; Wrecks/obstructions; Tracks/routes; Attention areas; Nav-Aids.

## 4 Declutter

Displays red when clearing overlapping objects.

## 5 Dangers

Red when "Guardian Technology" detects one of the following objects: Land, Intertidal, Depth Area, Rocks, Obstructions, Shoreline Constructions, Fishing Facility, Wrecks, Draggled area, Diffusion area, Mooring facilities, Pingos and Production installations.

## 6 Cautions

Red when "Guardian Technology" detects cautionary or restricted area.

## Palette

➤ [MENU] + "Map Options" + [ENTER] + "Palette" + [ENTER]

It is possible to set the palette used to enhance the visibility of the screen depending on the surrounding light condition. The possible choices are listed in the table below:

<b>Normal</b>	: It is recommended when the chart plotter is not exposed to the direct sunlight. When this mode is set the maps are displayed in order to use colors as similar as possible to the ones used in the original paper charts.
<b>Sunlight</b>	: It is designed to enhance the visibility of the screen when the chart plotter is exposed to the sunlight. The maps are much brighter than in the other modes and the depth areas are filled with white color so different depth areas are not easily distinguishable.
<b>Night Vision</b>	: It is recommended when the environment is dark in order to reduce the glare of the display. The chart plotter displays maps and screen in darker colors.
<b>NOAA</b>	: Allows setting NOAA paper chart colors presentation.

## Satellite Imagery

➤ [MENU] + "Map Options" + [ENTER] + "Satellite Imagery" + [ENTER]

It is possible to overlay the Satellite image for background map. When it is set On, the Palette is set to Normal to display the proper colors.

## Currents Prediction

➤ [MENU] + "Map Options" + [ENTER] + "Currents Prediction" + [ENTER]

A window is shown on the low-left side of the chart. It is possible to see the variation of the Tidal arrows on the selected area at any given time. Press the dedicated Soft Keys to set the date and time manually (press [Set]<sup>1</sup>), to decrease time (press [Decr]<sup>1</sup>) and to increase time (press [Incr]<sup>1</sup>), to exit (press [Exit]<sup>1</sup>).

**NOTE<sup>1</sup>** For SEAWAVE<sup>3</sup>, press [1, Set], [2, Decr] or [3, Incr] and [4, Exit].

### 3.3 OTHER MAP CONFIGURATIONS

➤ [MENU] + "Map Options" + [ENTER] + "Other Map Configurations" + [ENTER]  
 Allows the user to customize the following selections and is divided into: Marine Settings, Depth Settings, Land Settings, Chart Settings and Underwater Settings.

#### Display Mode

➤ [MENU] + "Map Options" + [ENTER] + "Other Map Configurations" + [ENTER] + "Display Mode" + [ENTER]

Selects from a predefined table what cartographic objects are displayed and which display options are set. Pre-programmed settings are user selectable from Full, Medium, Low, Radar, Tides, Custom. The table below shows the selections for each mode:

Setting	Full	Medium	Low	Radar	Tides	Custom (Default values)
Place Names	On	On	On	On	On	On
Name Tags	On	Off	Off	Off	Off	Off
Nav Aids & Light Sectors	On	No Sector	No Sector	No Sector	Off	On
Attention Areas	On	On	Off	Off	Off	On
Tides & Currents	On	Off	Off	Off	On	On
Seabed Type	On	Off	Off	Off	Off	On
Ports & Services	On	On	Off	On	Off	On
Tracks & Routes	On	Off	Off	Off	Off	On
Depth Range Min	0 Mt	0 Mt	0 Mt	0 Mt	0 Mt	0 Mt
Depth Range Max	9999 Mt	9999 Mt	9999 Mt	9999 Mt	9999 Mt	10 Mt
Land Elevations	On	On	Off	Off	Off	On
Land Elevation Values	On	Off	Off	Off	Off	On
Roads	On	Off	Off	Off	Off	On
POI	On	Off	Off	Off	Off	On
Lat/Lon Grid	On	Off	Off	Off	Off	On
Chart Boundaries	On	Auto	Off	Off	Off	Off
Value-Added Data	On	Off	Off	Off	Off	On
Chart Lock	On	On	On	On	On	On
Underwater Objects Limit	304 Mt	10 Mt	10 Mt	10 Mt	10 Mt	10 Mt
Rocks	Icon+Depth	Icon	Icon	Icon	Icon	Icon
Obstructions	Icon+Depth	Icon	Icon	Icon	Icon	Icon
Diffusers	Icon+Depth	Icon	Icon	Icon	Icon	Icon
Wrecks	Icon+Depth	Icon	Icon	Icon	Icon	Icon

#### Marine Settings

To control the display on the map of the marine features.

<b>Place Names</b>	: Sets On/Off the displaying of the Names (local area names).
<b>Name Tags</b>	: Sets On/Off the displaying of a tag for particular chart objects that either includes the Name of the chart object or the Depth of an Underwater chart object. Available for Buoys, Towers, Beacons and Port Marinas.
<b>Nav-Aids &amp; Light Sectors:</b>	Sets On/Off/No Sector the graphical presentation of Lights, Signals, Buoys and Beacons. If No Sector is selected Nav-Aids are shown, Light Sectors are hidden
<b>Attention Areas</b>	: Sets On/Off the displaying of Attention Areas (areas in which special attention by the mariner is required, because of natural or man-made hazards, or sailing regulations and restrictions. Moreover a special symbol (!) is placed inside the area selecting On option. This is valid also for the categories: FISHING FACILITY, MARINE FARM/CULTURE, MILITARY PRACTICE AREA, RESTRICTED AREA, SEAPLANE LANDING AREA. When the area is small, it is identified only by the boundary).
<b>Tides &amp; Currents</b>	: Sets On/Off the displaying of the Tides and Currents. When data/time is available, Tidal stream arrows are shown on the charts, indicating the direction and strength of the Tide. If no data/time is available from the GPS or the chart plotter is not in Simulation mode, the icon on the map is generic one. The color of the arrow denotes the strength of the current as follows:

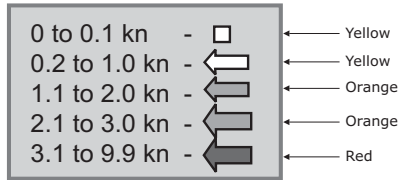

When the chart plotter receives a valid position fix, the Tide icons are shown on the charts on the basis of the current date and time: the screen displays and changes arrows as date/time changes.

<b>Seabed Type</b>	: Sets On/Off the displaying of the Seabed Type.
<b>Ports &amp; Services</b>	: Sets On/Off the displaying of the Ports and Services (areas along shore with facilities for mooring, downloading and uploading of ships, generally sheltered from waves and winds. Port installations are piers, wharves, pontoons, dry docks, cranes...).
<b>Tracks &amp; Routes</b>	: Sets On/Off the displaying of the Tracks and Routes (recommended and established routes for ships at sea, including traffic separation schemes, deep water routes).

## Depth Settings

To control the display on the map of the depth informations.

<b>Depth Range Min</b>	: Sets a minimum reference for the Depth Areas. The default setting is 0 Mt.
<b>Depth Range Max</b>	: Sets a maximum reference for the Depth Areas. The default setting is 9.999 Mt.

## Land Settings

To control the display on the map of the terrestrial features.

<b>Land Elevations</b>	: Sets On/Off the Land Elevation display.
<b>Land Elevations Values</b>	: Sets On/Off the displaying of the Land Elevations Values.
<b>Roads</b>	: Sets On/Off the displaying of the Roads.
<b>POIs</b>	: Sets On/Off the displaying of Points Of Interest.

## Chart Settings

To control the display on the map of the chart features.

<b>Lat/Lon Grid</b>	: Sets On/Off the displaying of the grid of parallels (of Latitude) and meridians (of Longitude) drawn on the map.
<b>Chart Boundaries</b>	: Sets On/Off the displaying of the Chart Boundaries, which represents the boundaries of the charts available on the chart plotter. Selecting Auto instead, if we are in background charts only the first chart levels contained in the DATA MEDIA are displayed, if we are in a charts level contained in the DATA MEDIA the next four charts level are displayed.
<b>Value-Added Data</b>	: Sets On/Off the displaying of the Value Added Data (VAD), a collection of additional cartographic objects which are not present on the original paper chart (from which the electronic chart derives).. These objects have been obtained from other sources and then merged to the electronic charts in order to provide more information useful for the navigation. VAD object can be any cartographic objects and it can be distinguished from the official-chart-objects from the Quick Info. A dedicated icon is shown on the Quick Info window to indicate that the object queried is a VAD. The same icon is also shown on the Full Info page and in addition the extended text Value Added Data is shown on the details of the VAD object.
<b>Chart Lock (*)</b>	: Sets On/Off the Chart Lock option. When Chart Lock is On, the available zoom scales are only the ones containing cartographic data. Instead when Chart Lock is Off, it is possible to zoom down into zoom scales not covered by cartographic data after the last available zoom scale covered by cartographic data. The DSI window, if present, will show "NO CHART", when an empty level is entered in the location of map expansion mode.

**NOTE\*** *When an empty level is entered, the message "No cartographic coverage" is shown on a window in a corner of the map display. The warning message is always displayed as long as the current zoom has no data coverage.*

## Underwater Objects Settings

To control the display on the Underwater Objects.



<b>Underwater Objects Limit</b>	: Selects the max depth value to display Underwater Objects. If value is set to 0 Mt, the Underwater Objects are not shown on the charts. If value is more than 0 Mt (i.e. 10 Mt), in the Range from 0 Mt to the selected value the Underwater Objects are displayed according to their default setting (shown here below). The default setting is 10 Mt.
<b>Rocks</b>	: Sets Off/Icon/Icon+Depth* the displaying of the Rocks. The default setting is Icon.
<b>Obstructions</b>	: Sets Off/Icon/Icon+Depth* the displaying of the Obstructions. The default setting is Icon.
<b>Diffusers</b>	: Sets Off/Icon/Icon+Depth* the displaying of Diffusers. The default setting is Icon.
<b>Wrecks</b>	: Sets Off/Icon/Icon+Depth* the displaying of Wrecks. The default setting is Icon.

**NOTE\*** Choose the options: *OFF (the object is not visible independently of the selected "Underwater Object Depth Value"); ICON (the object icon is visible without tags, in the range selected from "Underwater Object Depth Value" option); ICON+DEPTH (the object icon and tag is visible, in the range selected from "Underwater Object Depth Value" option).*

### 3.4 DISPLAY OPTIONS MENU

To allow you to change how the chart plotter displays information.

➤ **[MENU] + "Display Options" + [ENTER]**

<b>Auto Info</b>	: Displays information on cartographic object when the cursor is placed on it. The Automatic Info On Points shows information when the cursor is placed on points (as Port Services, Tides, lights, wrecks, rocks, buoys, beacons, obstructions, land markers, etc.). The Automatic Info On All shows information when the cursor is placed on points, on lines (as Depth contours, Traffic Separation, Territorial Sea, Cartographic Lines etc.) on areas (Depth, Built-up, Sea, Attention, Restricted etc.) and on names (on the beginning of the text -hot spot- or on any of the characters of the name -name message box-). The details on Land, Source of Data, Cartographic Area and Spot Soundings are not shown.
<b>Screen Amplifier</b>	: In Home mode the Screen Amplifier (Look Ahead) function sets up the charts on the navigation direction (course) in order to display more map details in front of the vessel's position.
<b>Course Line</b>	: Selects the value among Off/2/10/30 Min/1/2 hours/Infinite. The Course Line is a graphical indication of the direction in which the Vessel is heading. The Course Line origin is the vessel's position so the time line movement is synchronized with the vessels icon. Course Line "course" is given by the value of COG (Course Over Ground) and its length is proportional to the SOG (Speed Over Ground).
<b>Ship Icon Mode</b>	: Sets the Ship Icon Mode between Steady or Blinking. When Ship Icon Mode is Blinking, the ship icon (and the heading line) blinks every 1 second, otherwise when it is Steady the Ship Icon (and the heading line) does not blink.
<b>Coordinate System</b>	: Selects the Coordinate System among ddd mm ss (degrees, minutes and seconds), ddd mm.mm (degrees, minutes and hundredths of minute), ddd mm.mmm (degrees, minutes and thousandths of minute), UTM, OSGB, TD (allows conversion from GPS coordinates in Loranc coordinates and vice versa). If TD is selected as Coordinate System, a new menu appears on the screen to set Chain, Pair, ASF 1/2, Alternate Solution.
<b>Map Datum</b>	: Selects any Geodetic Datum reference from the over 100 available on the chart plotter. Map Datum selection switches to the selected reference datum applying the datum offsets stored with the charts.
<b>Fix Datum</b>	: Sets the datum reference used by the GPS receiver connected to (or integrated in) the chart plotter so that the chart plotter converts the position received from the GPS to the Map Datum currently selected in the menu in order to match the position from the GPS with the position on the charts. You must know what datum reference is used by the GPS and set it in the Fix Datum option.
<b>External WPT<sup>1</sup></b>	: The coordinates of a Waypoint, received from a GPS connected to the chart plotter, can be stored into the chart plotter, if the GPS is NMEA-0183 protocol compatible and support the \$BWC sentence (this symbol remains on the screen for 30 seconds). You may save it by placing a Waypoint or a Mark onto that symbol. As soon as the chart plotter receives another \$BWC sentence with the coordinates of a new Waypoint, the symbol moves to the new point.
<b>User Points</b>	: Sets On (icon + label), Off or Icon (only icon) the displaying of User Point.
<b>Symbol Size</b>	: Sets Normal or Small the icon of User Point.
<b>Event Handler Type<sup>2</sup></b>	: Selects the type as Normal or By Key. Selecting Normal allows placing the Event with a default name; selecting By Key allows setting the desire number for the Event. The default setting is Normal.
<b>Data Window Mode</b>	: Customizes the Text Area layout: it is possible to customize the Text Area layout among Full

Screen, Vertical, Text Area with 5 boxes and Text Area with 8 boxes (for Text Area with 5 boxes and Text Area with 8 boxes you can select between Small or Large boxes size).

---

<b>Cursor Window</b>	: Enables or disables the display of the cursor window on the screen.
<b>Position Symbol<sup>2</sup></b>	: Selects the icon of the fix position displayed on the screen between Boat and Standard. The default setting is Boat.
<b>Visual COG Bar</b>	: Enables or disables the display of the COG Bar, that shows the COG like a traditional compass.

---

**NOTE<sup>1</sup>** *NOT AVAILABLE FOR MARLIN/SEAWAVE<sup>3</sup>.*

**NOTE<sup>2</sup>** *AVAILABLE FOR MARLIN/SEAWAVE<sup>3</sup>.*

## SW701e/SW701i/SW701ce/SW701ci/SW1101/MARLIN/SEAWAVE<sup>3</sup>: 3.5 VIDEO MODE

This function allows to see a video input picture on the chart plotter screen. This is allowed only if an external video signal source is connected to the chart plotter.

**NOTE** *Once the Video Mode is active use the following keys to adjust video settings: press and immediately release [POWER], use the [Contr+]/[Contr-] and [Bright+]/[Bright-] soft keys to adjust contrast and backlight. **FOR SEAWAVE<sup>3</sup>**, use the [3, Contr+]/[4, Contr-] and [1, Bright+]/[2, Bright-] function keys to adjust contrast and backlight. Move the cursor up/down to adjust brightness and left/right to adjust colors, press [ZOOM IN]/[ZOOM OUT] to adjust hue phase. Pressing any other key exits from Video Mode.*

### 3.5.1 Add Video menu

➤ [MENU] + "Add Video" + [ENTER]

---

**Video 1:** Shows the image from the video camera 1 on a rectangular window, by moving the cursor keys you could select where this window is placed.

---

**Video 2 :** Shows the image from the video camera 2 on a rectangular window, by moving the cursor keys you could select where this window is placed.

---

**NOTE<sup>1</sup>** *FOR SW701i/SW701e/SW701ci/SW701ci: it is available only one video camera, so after selecting Add Video, the screen shows the image from the video camera on a window.*

### 3.5.2 Video Input menu

SW1101/SEAWAVE<sup>3</sup>:

➤ [PAGE] + "Video Input" + [ENTER]

MARLIN:

➤ [DATA] + "Video Input" + [ENTER]

---

<b>Full Screen Video 1</b>	: Shows the image from the video camera 1 at full screen.
<b>Full Screen Video 2</b>	: Shows the image from the video camera 2 at full screen.
<b>Full Screen Video 1 + Video 2</b>	: Shows the image from the video camera 1 at full screen and the image from the video camera 2 on a window which can be moved up/down and/or left/right using the cursor key, to select where the window is placed.
<b>Full Screen Video 2 + Video 1</b>	: Shows the image from the video camera 2 at full screen and the image from the video camera 1 on a window which can be moved up/down and/or left/right using the cursor key, to select where the window is placed.
<b>Radar/FF/Chart/Video 1</b>	: Shows the image from the video camera 1 on a rectangular window, in the left top corner, with Radar, Fish Finder and Chart.
<b>Radar/FF/Chart/Video 2</b>	: Shows the image from the video camera 2 on a rectangular window, in the left top corner, with Radar, Fish Finder and Chart.

---

SW701i/SW701e/SW701ci/SW701ci:

➤ [MENU] + "PAGE" + [ENTER] + "Video Input" + [ENTER]

---

<b>Full Screen Video</b>	: Shows the image from the video camera at full screen.
<b>Chart / Video</b>	: Shows the chart at full screen and the image from the video camera on a window which can be moved up/down and/or left/right using the cursor key, to select where

---

the window is placed.

---

**Radar/FF/Chart/Video** : Shows the image from the video camera on a rectangular window, in the left top corner, with Radar, Fish Finder and Chart.

---

## 3.6 ADVANCED OPTIONS MENU

- [MENU] + "Advanced Options" + [ENTER]

The Advanced Options are arranged in sub-menus.

### 3.6.1 Input/Output menu

#### WARNING

*After every software upgrade the RAM is cleared and the chart plotter re starts with the usual default settings. Please go to the Input/output menu and set the proper input format once again.*

**SW501e/SW501ce/SW701e/SW701ce/SW1101/SEAWAVE<sup>3</sup>/MARLIN/EXPLORER<sup>3</sup>:**

#### GPS Connection

Connect the GPS to the GPS Port (serial Port 3). To choose your preferred setting follow the procedure:

- [MENU] + "Advanced Options" + [ENTER] + "Input/Output" + [ENTER] + "Port 3 Input" + [ENTER] + "NMEA-4800-N81-N" + [ENTER]

#### GPS Setup Menu

To set your preferred configuration for the connected GPS.

---

<b>Internal GPS<sup>1</sup></b>	: Enables or disables the Internal GPS.
<b>Restart GPS</b>	: Restarts all GPS processes. Once executed, the message "Done" is shown.
<b>Diff. Corr. Source</b>	: Sets what kind of Differential Correction will be used by the GPS between WAAS and RTCM (beacon correction).
<b>Navigation Speed</b>	: Sets the Navigation Speed among Low Speed, Medium Speed and High Speed.

---

**NOTE<sup>1</sup>** AVAILABLE FOR SW501i/SW501ci/SW701i/SW701ci.

**SW501ce/SW501ci/SW701ce/SW701ci:**

#### Fish Finder Transmission

The internal Fish Finder is connected directly to the Port 2. To switch the internal Fish Finder transmission On/Off follow the procedure:

- [MENU] + "Advanced Options" + [ENTER] + "Input/Output" + [ENTER] + "FF Transmission" + [ENTER] + "On"/"Off" + [ENTER]

#### Autopilot Connection

Connect the Autopilot to the serial Port n:

- [MENU] + "Advanced Options" + [ENTER] + "Input/Output" + [ENTER] + "Port n Output" + [ENTER]. Then choose your preferred setting among the NMEA available settings NMEA 0183 4800-N81-N, NMEA 0180, NMEA 0180/CDX) and press [ENTER] to confirm.

Where:

- n = 1/2/3 for **SW501e/SW501i**
- n = 1/3 for **SW501ce/SW501ci**
- n = 1/2/3/4/5 for **SW701e/SW701i/SW1101/SEAWAVE<sup>3</sup>/MARLIN/EXPLORER<sup>3</sup>**
- n = 1/3/4/5 for **SW701ce/SW701ci**

#### External NMEA Connection

Connect the External NMEA to the serial Port n:

- [MENU] + "Advanced Options" + [ENTER] + "Input/Output" + [ENTER] + "Port n Input" + [ENTER]. Then choose your preferred setting among the NMEA available settings NMEA 1200-N81-N, NMEA 4800-N81-N, NMEA 4800-N82-N, NMEA 9600-N81-N, NMEA 38400-N81-N and press [ENTER] to confirm.

Where:

- n = 1/2/3 for SW501e/SW501i
- n = 1/3 for SW501ce/SW501ci
- n = 1/2/3/4/5 for SW701e/SW701i/SW1101/SEAWAVE<sup>3</sup>/MARLIN/EXPLORER<sup>3</sup>
- n = 1/3/4/5 for SW701ce/SW701ci

## C-COM GSM Plus Connection

To connect the modem C-COM to the chart plotter follow the procedure:

- [MENU] + "Advanced Options" + [ENTER] + "Input/Output" + [ENTER] + "Port 1 Input" + [ENTER] + "C-COM" + [ENTER]

The modem C-COM can be connected also to the Port 2 (except for SW501ce/SW501ci/SW701ce/SW701ci), Port 3 and Port 4/5 (except for SW501e/SW501i/SW501ce/SW501ci), in this case select the format on the used port.

**NOTE** *The connection is valid for the C-COM IR and C-COM RS232 too.*

## Output Sentences

The chart plotter allows customizing the NMEA-0183 sentence transmitted on each port. Each port can transmit a different set of sentences among: GLL, VTG, BOD, XTE, BWC, RMA, RMB, RMC, APB, WCV, GGA, HSC, HDG, MWV:

- [MENU] + "Advanced Options" + [ENTER] + "Input/Output" + [ENTER] + "Port n Output Sentences" + [ENTER]

Where:

- n = 1/2/3 for SW501e/SW501i
- n = 1/3 for SW501ce/SW501ci
- n = 1/2/3/4/5 for SW701e/SW701i/SW1101/SEAWAVE<sup>3</sup>/MARLIN/EXPLORER<sup>3</sup>
- n = 1/3/4/5 for SW701ce/SW701ci

## NMEA-0183 Output Talker ID

The Talker Id is the 2 characters following the "\$" char (Start of sentence) in a NMEA-0183 sentence that identifies the type of instrument that sends the string. The chart plotter allows selecting one of the following Talker identifier: II (Integrated Instrument); GP (GPS); EC (Electronic Chart System-ECS); RA (Radar and/or Radar Plotting); SD (Sounder Depth). The selected Talker ID is applied to all sentences sent by the chart plotter from all Ports.

To select the Talker ID follow the procedure:

- [MENU] + "Advanced Options" + [ENTER] + "Input/Output" + [ENTER] + "NMEA-0183 Output Talker ID" + [ENTER] + "II/GP/EC/RA/SD" + [ENTER]

SW701e/SW701i/SW701ce/SW701ci/SW1101/SEAWAVE<sup>3</sup>/MARLIN/EXPLORER<sup>3</sup>:

## External Signal

Sets the External Output:

- [MENU] + "Advanced Options" + [ENTER] + "Input/Output" + [ENTER] + "External Signal" + [ENTER]

Then choose your preferred setting among External Alarm (when activated, this pin goes to GND level. It is used to command an external buzzer), External Power (it is command switch for the Radar. It must be used in conjunction with the Radar Junction box device) and Off.

## Cable Wiring pages

This menu allows you select the Cable Wiring page preferred:

- [MENU] + "Advanced Options" + [ENTER] + "Input/Output" + [ENTER] + "Cable Wiring" + [ENTER]

---

<b>Power I/O Cable Wiring</b> <sup>1</sup>	: Shows a window containing the Power I/O cable wiring.
<b>Quick Disconnect Cable Wiring</b> <sup>2</sup>	: Shows a window containing the quick disconnect bracket cable wiring.
<b>GPS Cable Wiring</b> <sup>1</sup>	: Shows a window containing the GPS cable wiring.
<b>AUX In I/O Cable Wiring</b> <sup>2</sup>	: Shows a window containing the AUX IN I/O cable wiring.
<b>I/O Port 1-2</b> <sup>4</sup>	: Shows a window containing the Port 1 and 2 cable wiring.
<b>I/O Port 4-5</b> <sup>4</sup>	: Shows a window containing the Port 4 and 5 cable wiring.
<b>I/O Port 3 - GPS</b> <sup>4</sup>	: Shows a window containing the Port 3 - GPS cable wiring.

---

**NOTE**<sup>1</sup> *AVAILABLE FOR SW1101/SEAWAVE<sup>3</sup>/EXPLORER<sup>3</sup>.*

**NOTE**<sup>2</sup> *AVAILABLE FOR SW701e/SW701i/SW701ce/SW701ci/SW1101.*

**NOTE**<sup>3</sup> *AVAILABLE FOR SW501e/SW501i/SW501ce/SW501ci/SW701e/SW701i/SW701ce/SW701ci/SEAWAVE<sup>3</sup>/EXPLORER<sup>3</sup>.*

**NOTE**<sup>4</sup> *AVAILABLE FOR MARLIN.*

## Send/Receive Routes & Marks

Sets the desired port used for transferring User Points and Routes functions:

- [MENU] + "Advanced Options" + [ENTER] + "Input/Output" + [ENTER] + "Send/Rec Rts & Mrks" + [ENTER] + "Port n" + [ENTER]

Where:

- n = 1/2/3 for **SW501e/SW501i**
- n = 1/3 for **SW501ce/SW501ci**
- n = 1/2/3/4/5 for **SW701e/SW701i/SW1101/SEAWAVE<sup>3</sup>/MARLIN/EXPLORER<sup>3</sup>**
- n = 1/3/4/5 for **SW701ce/SW701ci**

### 3.6.2 C-Link menu

Select the Primary or Secondary Station (see the dedicated Chapter):

- [MENU] + "Advanced Options" + [ENTER] + "C-Link" + [ENTER] + "Secondary Station/Primary Station" + [ENTER]

### 3.6.3 Fix & Compass menu

To handle the functions related to navigation and to set the reference heading information such as bearing angles (True or Magnetic), the Magnetic Variation source and to enter Compass Calibration values.

- [MENU] + "Advanced Options" + [ENTER] + "Fix & Compass" + [ENTER]

---

<b>Fix Correction</b>	: Turns On/Off the Correction from the positioning system. If the new Correction is calculated, but the Correction is not enabled, the ship's position is not changed.
<b>Compute Correction</b>	: Corrects fixes from the positioning instrument. By placing the cursor on the ship's real position and selecting this option, the error is calculated and internally memorized for appropriate correction, but not applied.
<b>Correction Offset</b>	: Manual correction of fix position.
<b>Static Navigation</b> <sup>1</sup>	: Sets up a threshold for the speed. When the speed received from the positioning device is under that threshold, the chart plotter displays zero speed.
<b>Position Filter</b>	: Turns On/Off the Position Filter. In case of a jittering fix this option makes the ship's position more stable and the track smoother.
<b>Speed Filter</b>	: Turns On/Off the Speed Filter. When it is On, you can filter the speed of the ship, to optimize it.
<b>Bearing</b>	: Selects either degrees magnetic, Auto Mag, or True. If magnetic readings are selected the variation is computed automatically for every zone as soon as the chart is displayed.
<b>Magnetic Variation</b>	: It is possible to calculate the Magnetic Variation in an Automatic or manual mode, by inserting the step for calculation of Magnetic Variation.
<b>Calibrate Compass</b>	: The variation table is used to match magnetic value readout on the chart plotter comparable

---

with the value given by the compass of the boat. In other words, since the compass of the boat must be compensated (due to the iron masses, ...), we use the same values given by the chart plotter. This means that, for example, if the BRG to the next Waypoint readout in the chart plotter display is "X" Mag degree, if you steer the boat reading "X" Mag degree from the compass, you are driving well toward the next Waypoint.

---

**NOTE<sup>1</sup>** *AVAILABLE FOR SW1101/SEAWAVE<sup>3</sup>/MARLIN/EXPLORER<sup>3</sup>.*

## 3.7 AIS

AIS is an Automatic Identification System. It has been introduced to improve the safety of navigation by assisting in the efficient operation of ship-to ship, ship reporting and VTS applications. The system should enable operators to obtain information from the ship automatically, requiring a minimum of involvement of ship's personnel, and should have a high level of availability. AIS transponders installed on IMO vessels use VHF frequencies to:

- ◆ Transmit details of their own vessel
- ◆ Receive details from other vessels or navigation aids within VHF range.

Information being transmitted from vessels over 300 tons that, due to recent worldwide legislation, are required to fit Class "A" AIS transponders.

Connecting to the chart plotter an AIS receiver (please contact your local dealer), vessels with AIS transponder within VHF range are displayed on screen giving the skipper or navigator a visual interpretation of the data of nearby vessels. This improves safety, and specifically for collision avoidance reasons.

### 3.7.1 AIS System Definitions

- ◆ **Target**  
It is a vessel equipped with AIS. Information about the Targets is being received by AIS Receiver and displayed on the screen.
- ◆ **CPA**  
Closest Point of Approach is the closest distance that will be achieved between your vessel and the tracked Target, based on your vessel's speed and direction and the Target's speed and direction.
- ◆ **CPA Limit**  
This is the distance from your vessel that a Target may reach before a Target is deemed a threat.
- ◆ **CPA Alarm**  
Occurs if CPA is less or equal to CPA Limit. This test is done for active Targets only.
- ◆ **TCPA**  
Time to closest Point of Approach is the time remaining until the CPA will occur.
- ◆ **TCPA Limit**  
This is the time remaining before the CPA is reached.
- ◆ **TCPA Alarm**  
Occurs if TCPA is less or equal to TCPA Limit. This test is done for active Targets only and if CPA value is less or equal to CPA Limit.
- ◆ **Radio Call Sign**  
International call sign assigned to vessel, often used on voice radio.
- ◆ **Name**  
Name of ship, 20 characters.
- ◆ **MMSI**  
Maritime Mobile Service Identity.
- ◆ **MMSI number**  
A unique 9 digit number that is assigned to a DSC radio station. It prima-

rily registers the boat information in the U.S. Coast Guard's national distress database for use in emergency situations.

- ♦ **Active Target**  
Target located within the Activation Range. Active Target is represented by oriented triangle with COG and Heading vectors. Rate of turn may also be displayed.
- ♦ **Dangerous Target**  
Target detected by CPA or TCPA Alarm. Dangerous Target is Active Target by definition. For better visibility Dangerous Target symbol is flashing.
- ♦ **Sleeping Target**  
Target located outside the Activation Range. Sleeping Target is represented by a small oriented triangle.
- ♦ **Lost Target**  
When the AIS info is not received from that vessel for 3.5 minutes. The presentation will be a flashing black triangle with a cross through.
- ♦ **Activation Range**  
Range around your boat where Targets become active. AIS Target become active within this range. Activation Range should be greater than CPA Limit by definition.

**NOTE** *A Target is removed from the screen if data is not received for 10 minutes. The maximum number of tracked Targets is 200. Depending on the scale the presentation of the Targets change to remove clutter on the screen. This information is updated every 3 seconds to 6 minutes depending on speed and rate of turn, enabling the track of the vessels in range to be plotted.*





TARGET STATUS	DESCRIPTION	SYMBOL
ACTIVE TARGET	Target located within the Activation Range.	
DANGEROUS TARGET	Target detected by CPA or TCPA Alarm. Dangerous Target is Active Target by definition.	
SLEEPING TARGET	Target located outside the Activation Range.	
LOST TARGET	Ais info is not received from that vessel for 3.5 minutes.	

Fig. 3.7.1 - AIS Symbols

### 3.7.2 To set the chart plotter for receiving AIS

Make sure that the AIS receiver is properly connected to the chart plotter.

The chart plotter reads the AIS NMEA message VMD, type 1, 2, 3 and 5.

Select the used serial port and transmission speed by following the procedure:

- [MENU] + "Advanced Options" + [ENTER] + "Input/Output" + [ENTER] + "Port n Input" + [ENTER] + "AIS 38400" + [ENTER]

Where:

- n = 1/2/3 for **SW501e**
- n = 1/2 for **SW501i**
- n = 1/3 for **SW501ce**
- n = 1 for **SW501ci**
- n = 1/2/3/4/5 for **SW701e/SW1101SEAWAVE<sup>3</sup>/MARLIN/EXPLORER<sup>3</sup>**
- n = 1/2/4/5 for **SW701i**
- n = 1/3/4/5 for **SW701ce**
- n = 1/4/5 for **SW701ci**

### 3.7.3 AIS Menu

To configure the chart plotter to receive AIS data, follow the procedure:

- [MENU] + "AIS" + [ENTER]

## SW1101:

➤ [DATA] + "AIS" + [ENTER]

<b>Display</b>	: Turns Off the display of AIS targets overlay on the cartography or defines the range from the fix within which the AIS Target becomes active. The values allowed are from 0.1 to 20 Nm. The default setting is 5 Nm.
<b>CPA Alarm</b>	: Turns Off the alarm or defines the CPA Limit (the values allowed are from 0.1 to 10 Nm). The default setting is Off.
<b>TCPA Alarm</b>	: Turns Off the alarm or defines the TCPA Limit (The values allowed are from 1 to 30 min). The default setting is Off.
<b>AIS Report</b>	: Shows the AIS List page which contains basic information of the Target ship with the ability to select a Target ship and locate it on the chart.

**NOTE** *The AIS menu could be selected only if the AIS has been selected as external device, see the previous Par. 3.7.2.*

### 3.7.4 Quick Info on AIS Target

By placing the cursor over a AIS Target icon, the following information is displayed:

- **Vessel Name**
- **MMSI number**
- **Radio Call Sign**
- **SOG**
- **COG**
- **CPA and TCPA values**

**NOTE** *The selected AIS Target icon is surrounded by a square frame when user places the cursor over the icon.*

## 3.8 C-WEATHER SERVICE

C-Weather Service is an innovative meteorological forecasting system with the ability to visualize the weather forecast, overlaying it on cartography. The weather data is held on Jeppesen Marine's weather server, which can be accessed via a C-COM modem connected to the chart plotter or by using the PC Planner (or the DPS - Dealer Programming System) saving the weather data on a USER MEDIA. The weather data are overlaid on a map page as layers. The Weather format data available are:







Data Type	Display
WIND (Speed & Dir)	- 0 ➔
WAVE (Height & Dir)	- 1 ➔
TEMPERATURE (C°)	18°
HUMIDITY (%)	30
VISIBILITY (m)	20
WEATHER TYPE: Sun	
WEATHER TYPE: Rain	
WEATHER TYPE: Fog	
WEATHER TYPE: Snow	
WEATHER TYPE: Clouds	
WEATHER TYPE: Partly Cloudy	
WEATHER TYPE: Thunderstorm	

Fig. 3.8 - Weather data package

**NOTE** *Refer to Par. 3.1 General Options menu for selecting the desired unit of measure.*



### 3.8.1 C-WEATHER SERVICE Menu

To select the menu:

- [MENU] + "C-Weather" + [ENTER]

SW1101:

- [DATA] + "C-Weather" + [ENTER]

It opens a sub-menu with the following options.

- ◆ Copy from USER MEDIA
- ◆ Download
- ◆ Forecast
- ◆ Real Time View
- ◆ Type of Data

#### Copy from USER MEDIA

- [MENU] + "C-Weather" + [ENTER] + "Copy from USER MEDIA" + [ENTER]

SW1101:

- [DATA] + "C-Weather" + [ENTER] + "Copy from USER MEDIA" + [ENTER]

Allows the whole data package C-Weather loading from the USER MEDIA.

#### Download

- [MENU] + "C-Weather" + [ENTER] + "Download" + [ENTER]

SW1101:

- [DATA] + "C-Weather" + [ENTER] + "Download" + [ENTER]

Allows to connect the software to the Jeppesen Marine weather server and to download Jeppesen Marine weather data directly via C-COM. It activates the following sub-menu:

<b>Select Country to Call</b>	: Allows the selection of the country to call.
<b>Telephone Number</b>	: Allows the insertion of the number.
<b>SIM Pin</b>	: Allows inserting of the PIN of the SIM.
<b>Download Area</b>	: Allows the weather download: a squared grey area, where the weather data will be downloaded, is centered on cursor position. See the following picture.

Area of coverage of downloaded data is located by default with its centre on the cursor position

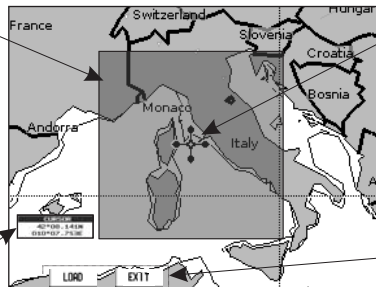

Cursor is locked to the grey area. Moving the cursor also moves the grey area allowing locating it over the area where the user wants to download the Meteo forecast.

Indicates the LAT/LON position of the cursor

Soft Keys to manage the download procedure

Fig. 3.8.1 - Download Area

**Press [Load]<sup>1</sup> to activate the C-Weather Download:** the whole data package (see the previous "Weather data package" table) are downloaded. At the end of the operation press [Exit]<sup>1</sup> to close the window.

**NOTE<sup>1</sup>** FOR SEAWAVE<sup>2</sup>, press [1, Load] or [2, Exit].

#### Forecast

- [MENU] + "C-Weather" + [ENTER] + "Forecast" + [ENTER]

SW1101:

- [DATA] + "C-Weather" + [ENTER] + "Forecast" + [ENTER]

Allows selecting the Layer of specific weather data to be displayed on the screen and to change date and time of the forecast preview.

The following functions are available:

- **Panning:** default usage of the cursor key is the normal panning function.
- **Zoom in/out:** zoom in/out functions are allowed as usual by using [ZOOM IN]/[ZOOM OUT].
- **Set of date and time:** [Date/Time]<sup>1</sup> to modify date and time values.
- **Layer selection:** [Type]<sup>1</sup> to cycle of the weather layers.
- **Exit:** [Exit]<sup>1</sup> or [CLEAR] to close the weather prediction page.

**NOTE<sup>1</sup>** For SEAWAVE<sup>3</sup>, press [1, Type], [2, Date/Time] or [3, Exit].

## Real Time View

- [MENU] + "C-Weather" + [ENTER] + "Real Time View" + [ENTER]

SW1101:

- [DATA] + "C-Weather" + [ENTER] + "Real Time View" + [ENTER]

The following selections are available:

- **Real Time View On:** the data is shown (the area of the download) at the current date and time (received from the GPS).
- **Real Time View Off:** the Weather data is not displayed.

The layer displayed is the one selected into the previous menu item.

## Type of Data

- [MENU] + "C-Weather" + [ENTER] + "Type od Data" + [ENTER]

SW1101:

- [DATA] + "C-Weather" + [ENTER] + "Type od Data" + [ENTER]

Allows selecting the type of data, see the previous Fig. 3.8.

SW701e/SW701i/SW701ce/SW701ci/SW1101/SEAWAVE<sup>3</sup>/MARLIN/  
EXPLORER<sup>3</sup>:

## 3.9 DSC

### WARNING

*The chart plotter must be interfaced with a DSC VHF radio.*

The DSC (*Digital Selective Calling*) is a method of establishing a VHF radio call; it is used to announce urgent maritime safety information broadcasts. This system allows mariners to instantly send Distress Call or/and Position Request to the other vessels equipped with a DSC transceiver within range of the transmission. The Distress Call, that allows to receive a position of the vessel in distress, and the Position Request, a great feature for anyone wanting to know the location of another vessel - for example you buddy that is catching fish, or finding the location of a person you are cruising with, are performed by an external device, the DSC VHF radio. The chart plotter interfaced with a DSC VHF radio prompts the user to see the GPS position of the vessel in distress and also allows for easy navigation to the vessel.

The Distress Call and the Position Request icons that are displaying on the screen, are shown in the following table.

**NOTE** *The label can be the MMSI or the corresponding vessel's name. If in the DSC Directory the MMSI has been associated to its relative vessel name, the vessel's name is shown in the label instead of the MMSI.*



DESCRIPTION	SYMBOL
Position Request icon	
Distress Call icon	

Fig. 3.9 - Distress Call and Position Request icons

### 3.9.1 Distress Call and Position Request

During a distress situation, a vessel that is equipped with a DSC VHF radio and connected to a GPS, has the capability to transmit a DSC Distress Call with GPS Position.

When the VHF radio receives a DSC Distress Call, the position information of the vessel in distress is transferred to the chart plotter. The chart plotter logs the Distress Call into the DSC Log and also marks the position of the vessel in distress on the Chart page. A pop-up screen advises the user that a Distress Call has been received. Within the pop-up screen it asks the user if he would like to view the call on the Chart page or exit the pop-up screen. By selecting the item "VIEW ON CHART" and press **[ENTER]** two options are shown:

- ◆ **GoTo Vessel**  
Activates the navigation to the Distress Call or Position Request icon. The chart plotter changes the map scale to allow showing the Distress Call (or Position Request) icon and the vessel's icon simultaneously on the screen. The chart plotter then verifies if there are obstructions (land or low water) between the two positions. If obstructions are found the chart plotter shows a pop-up screen saying that the navigation to the Distress Call cannot be set automatically and the user must define a route to avoid the obstacles.
- ◆ **Stay on View**  
Exits the pop-up screen and remains on the selected map screen.

### 3.9.2 DSC Log page

To select the DSC Log page:

- **[PAGE] + "DSC" + [ENTER] + select the DSC Log page + [ENTER]**

**MARLIN:**

- **[DATA] + "DSC" + [ENTER] + select the DSC Log page + [ENTER]**

**EXPLORER<sup>3</sup>:**

- **[MENU] + "Page" + [ENTER] + select the DSC Log page + [ENTER]**

Selecting Log shows the Distress Call Log page or Position Request Log page (it depends which of the two was selected).

DATE TIME	LAT LONG	NAME MMSI	SHOWN
03-03-01 08:31 PM	33°30.505 N 118°18.529 W	0080457645	NO
03-04-01 00:11 PM	33°34.157 N 118°21.864 W	ROY 0023244524	YES
03-04-01 08:31 PM	33°31.211 N 118°29.151 W	BOBI 0086477743	NO
ENTER to change mode POSITION REQUEST			
(LOCATE)	(CLR-ONE)	(CLR-ALL)	(HIDE)

Fig. 3.9.2 - Example of DSC Log page



Pressing **[ENTER]** it is possible, by selecting "DELETE" deletes the DSC icon from the DSC Log page, otherwise by selecting "DSC LOG" the DSC Log page is shown.

### 3.10 FISH FINDER

The chart plotter combined with the sonar performance of the Fish Finder is one of the most advanced marine navigation system available.

To select the Fish Finder menu, first select one of the pages related to the Fish Finder:

- **[PAGE] + "Fish Finder" + [ENTER] + select the desired page + [ENTER]**

**MARLIN:**

- **[DATA] + "Fish Finder" + [ENTER] + select the desired page + [ENTER]**

**EXPLORER<sup>3</sup>:**

- **[MENU] + "Fish Finder" + [ENTER] + select the desired page + [ENTER]**

Once the Fish Finder page is selected, access the Fish Finder menu by pressing:

- **[MENU]**

For more information see the specific User Manual (or Chapter 5).

**NOTE** *The Fish Finder display page is available only if the Fish Finder is connected/ internal and turned On.*

**SW701e/SW701i/SW701ce/SW701ci/SW1101/SEAWAVE<sup>3</sup>/MARLIN/  
EXPLORER<sup>3</sup>:**

### 3.11 RADAR

The Radar consists of a scanner unit which illuminates targets with microwave energy and then collects the echoes from those targets. The scanner unit includes the Radar antenna, transmitter, receiver and necessary electronics. The scanner unit is connected to a chart plotter equipped with software capable of displaying the Radar functions.

To select the Radar menu, first select one of the pages related to the Radar:

- **[PAGE] + "Radar" + [ENTER] + select the desired page + [ENTER]**

**MARLIN:**

- **[DATA] + "Radar" + [ENTER] + select the desired page + [ENTER]**

**EXPLORER<sup>3</sup>:**

- **[MENU] + "Radar" + [ENTER] + select the desired page + [ENTER]**

Once the Radar page is selected, access the Radar menu by pressing:

- **[MENU]**

For more information see the specific User Manual.

**NOTE** *The Radar display page is available only if the Radar is connected and powered On.*

### 3.12 SYSTEM INFORMATION

To see details about the software and cartography data installed.

- **[MENU] + "About..." + [ENTER]**

Opens the System Information page.



## 4. C-Link

---

C-Link system is a feature which allows to sharing the same Navigation Data (Route Name, Destination ID & Position, Next Waypoint ID & Position, Total Route length, Fuel Consumption Rate, ETA, TTG etc.) between two chart plotter units linked via serial I/O port.

### 4.1 C-LINK SERIAL CONNECTION

The two chart plotters should be connected via serial ports. Any of the available ports can be used, the software will recognize automatically the serial ports used. A typical connection is as follows:

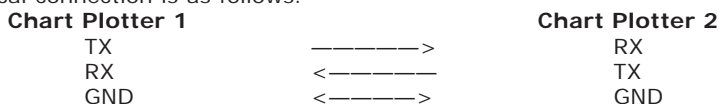

### 4.2 C-LINK NAVIGATION DATA TRANSFER

The chart plotters can be set to operate in two modes:

- ♦ MASTER mode (Primary Chart Plotter)
- ♦ SLAVE mode (Secondary Chart Plotter)

When the navigation is activated on the Master chart plotter, the C-Link navigation data will be continuously sent to the Slave until the navigation is active.

If the Master is navigating to a Single Destination, the Slave will show the Destination position and activate the navigation to it.

If the Master is navigating to a Route, the Slave will show the Route Leg composed by the Destination and the Waypoint after the Destination (Next Waypoint) and activate the navigation to it.

Any variation to the current C-Link Navigation Data will be transferred from the Master to the Slave. The Slave will be provided with a dedicated page to show the C-Link Navigation Data received from the Master, selected from the Route menu:

➤ [MENU] + "Route" + [ENTER] + "Report" + [ENTER]

SW1101:

➤ [DATA] + "Route" + [ENTER] + "Report" + [ENTER]

A data page (different from the Route Data Report page) appears on the screen, that shows the C-Link Navigation Data sent from the Master.

### 4.3 OPERATIONS

#### INTRODUCTIVE ELEMENTS

It is important remark, once more, that this function does not transfer the whole route but just the information relative to the navigation. Such information will be removed from the Slave chart plotter as soon as the navigation is terminated.

C-Link navigation data is exchanged by using two NMEA-0183 C-MAP proprietary sentences: \$PCMPN,1 and \$PCMPN,2.

When the navigation is activated on the Master, it starts outputting the C-Link Navigation Data. If the Slave is connected, all C-Link Navigation Data received are stored in its memory and the navigation is started.

The information sent by the Master consists of the following values:

- ◆ Navigation mode (To Single Destination/to a Route)
- ◆ Route Name\*
- ◆ Destination ID
- ◆ Destination Position
- ◆ Next Waypoint ID\*
- ◆ Range from Destination to next Waypoint\*
- ◆ Bearing from Destination to next Waypoint\*
- ◆ Route Length\*
- ◆ Distance from Destination to Last Route Waypoint\*
- ◆ Remaining Route Legs\*
- ◆ Planned Cruising Speed
- ◆ Average Fuel Consumption
- ◆ Initial Fuel Load

Values identified by \* are sent only for Route Following navigation.

The Destination Icon, Navigation leg (Fix Position to Destination), the Next Waypoint Icon and all other relevant C-Link Navigation Data will be shown on the Slave chart plotter. Any variation of the C-Link Navigation Data on the Master will be communicated to the Slave so to keep data aligned on both devices.

## MASTER CHART PLOTTER

### Operating mode

To select the Master mode follow the procedure:

- [MENU] + "Advanced Options" + [ENTER] + "C-Link" + [ENTER] + "Primary Station" + [ENTER]

Master mode is the default factory setting. All regular chart plotters functions are allowed. As soon as the Destination is placed, the Master chart plotter will start transmitting all C-Link Navigation Data.

In Master mode the C-Link Navigation Data received from the NMEA port is ignored. So, if the two chart plotters are both operating in Master mode, the C-Link Navigation Data sent by the other chart plotter never processed.

Under such condition if the navigation is activated on one of the two chart plotters, a warning message will be shown to notify that the C-Link navigation data will be ignored by the other chart plotter.

## SLAVE CHART PLOTTER

### Operating mode

To select the Slave mode follow the procedure:

- [MENU] + "Advanced Options" + [ENTER] + "C-Link" + [ENTER] + "Secondary Station" + [ENTER]

When Slave mode is set, the chart plotter cannot manipulate the C-Link Navigation Data anymore.

It is necessary to disable the Internal GPS on the Slave chart plotter before start to work with the C-Link system:

- [MENU] + "Advanced Options" + [ENTER] + "Input/Output" + [ENTER] + "GPS Configuration" + [ENTER] + "GPS Antenna" + [ENTER] + "No" + [ENTER]

### Stop current navigation

If the navigation was already active, it will be disabled as soon as Slave mode is set. An appropriate warning message will be shown to notify that the Navigation is already active and to confirm whether Slave mode can be set.



### Inhibit Navigation operation

As soon as Slave mode is set, the Destination cannot be placed anymore either the C-Link Navigation Data is received from the Master or not. Also, when the C-Link Navigation Data is received from the Master, it will not be allowed to deactivate the Navigation.

### Inhibit Route following

While navigating to the route received from the Master and the Destination is reached the Destination will be moved to the next Waypoint on the route.

### MOB handling

If the Navigation to the external Destination is active and **[MOB]** is pressed on the Slave chart plotter, the MOB is placed but the navigation to the MOB is not activated.

**Note** *While navigating to the external Destination the operating mode is switched to Master, the navigation to the external Destination will be terminated.*

## C-LINK NAVIGATION DATA: ACQUISITION AND DISPLAY

As soon as the C-Link Navigation Data is received, the Slave parses the information received and executes the relative actions depending on its current working status.

**Note** *When the Navigation to the external Destination is activated, the Slave Chart Plotter will show all relevant C-Link Navigation Data exactly like when the Destination is not the external one (Destination Name, DST and BRG to Destination, calculate XTE, calculate TTG etc). These values will be displayed all places where required and they will be used to format NMEA-0183 output data.*

## GRAPHICAL REPRESENTATION ON MAP DISPLAY



DESCRIPTION	SYMBOL
External Destination - RED Icon	
Next Waypoint - GREEN Icon	
Navigation Leg - RED Line	

Fig. 4.3 - Graphical Displaying

## ROUTE DATA REPORT

On the Slave chart plotter, when the navigation to the External route is received, it is possible to display the information related to the External route by entering the Route Data Report:

➤ **[MENU] + "Route" + [ENTER] + "Report" + [ENTER]**

**SW1101:**

➤ **[DATA] + "Route" + [ENTER] + "Reporto" + [ENTER]**

External Route: <b>ROUTE001</b>				
Cruising Speed:	<b>12.5 kn</b>	Fuel Consumption Rate:	<b>8.0 l/h</b>	
Total Route length:	<b>71.19 Nm</b>	Total Fuel Consumption:	<b>45.5 l</b>	
Waypoints in Route:	<b>4</b>	Initial Fuel Load:	<b>255 l</b>	
Remaining Waypoints:	<b>4</b>	Remaining Fuel:	<b>209 l</b>	
	<b>DST</b> (nm)	<b>TTG:</b> (hh:mm)	<b>ETA:</b> (hh:mm)	<b>Cons</b> Lit
To Dest	<b>11.93</b>	<b>00:57</b>	<b>11:54 AM</b>	<b>7.4</b>
To Next Wpt	<b>15.97</b>	<b>01:16</b>	<b>1:10 PM</b>	<b>12.3</b>
To Last Wpt	<b>83.12</b>	<b>05:41</b>	<b>6:54 PM</b>	<b>54.4</b>

Fig. 4.3a - External route on Route Data Report

- External Route : Name of the External Route (from \$PCMPN,0)
- Cruising Speed : Planned Cruising Speed (from \$PCMPN,1)
- Total Route length : Length from First to Last Wpt (from \$PCMPN,1)
- Waypoints in Route : No. of Wpts in the Route (from \$PCMPN,1)
- Remaining Waypoints : No. of Wpts from Dest to Last Wpt (from \$PCMPN,1)
- Fuel Consumption Rate : Planned Fuel Consumption Rate (from \$PCMPN,1)
- Total Fuel Consumption : Calculated Fuel consumption to navigate the whole Route
- Initial Fuel Load : Volume of Fuel available before the navigation was started (Liters)
- Remaining Fuel : Volume of Fuel available (Liters)
- Distance to Destination : Distance from Ship to Destination (calculated)
- Distance to Next Wpt : Distance to travel from ship to the Wpt after the Destination (calculated: Distance to Dest + Next Route Leg length)
- Distance to Last Wpt : Distance to travel from ship to the End of the Route (calculated: Distance to Dest +Distance From Dest to last Wpt received from \$PCMPN,1)
- TTG To Destination : Estimated Time to travel the "Distance to Last Wpt" (calculated using Cruising Speed)
- TTG To Next Wpt : Estimated Time to travel the "Distance to Next Waypoint" (calculated using Cruising Speed)
- TTG to Last Wpt : Estimated Time to travel the "Distance to Last Wpt" (calculated using Cruising Speed)
- ETA to Destination : Estimate Time of Arrival to the Destination Point (calculated: Current Time + "TTG To Destination")
- ETA to Next Waypoint : Estimate Time of Arrival to the Waypoint after the Destination (calculated: Current

- ETA to Last Wpt : Time + "TTG To Next Waypoint")  
: Estimate Time of Arrival to the End of the Route (calculated: Current Time + "TTG To Last Wpt")

## 4.4 QUICK INFO

### Route Navigation: Quick Info on the Destination

EXTERNAL Rte [ROUTE001 ]			
	DST (nm)	TTG: {hh:mm}	Cons Lit
Dest	11.93	00:57	7.41
Last	83.12	05:41	54.4
Route Length: 71.19 Nm			

Route Name, DESTINATION ID Wpt1/4

Distance, TTG and Consumption from Ship to Dest  
Distance, TTG and Consumption from Ship to Last Wpt

Fig. 4.4 - Quick Info on Destination

### Quick info on Single Destination

EXTERNAL DESTINATION WPT002	
DST 7.41 Nm	ERG 082° M

Fig. 4.4a - Quick Info on Single Destination



# 5. Fish Finder

SW501ce/SW501ci/SW701ce/SW701ci

---

The Fish Finder consists of a high power transmitter, sensitive receiver and a transducer. The Fish Finder sends an electrical pulse to the transducer which contains an element that converts the pulse into acoustic (sound) wave which is sent through the water. As this wave travels from the transducer to the bottom, it may strike fish, structures, thermoclines (temperature changes in the water). When the wave strikes an object(s) a certain amount of the wave is reflected back to the transducer depending on the composition and shape of the object. When the reflected wave is returned to the transducer it is converted into a voltage and is amplified by the receiver, processed and sent to the display. The speed of sound in water is roughly 4800 ft./sec, so the time lapse between the transmitted signal and the received echo can be measured and the distance to the object determined.

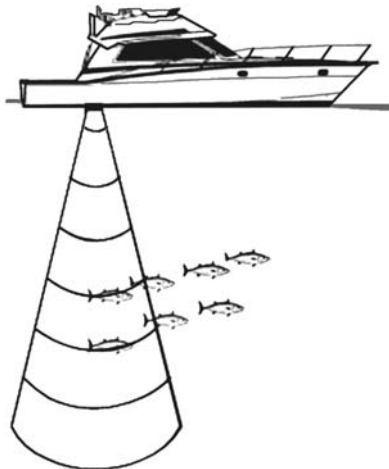

Fig. 5 - Fish Finder working principle

## 5.1 SETTING THE INTERNAL FISH FINDER ON

The Fish Finder driver is embedded on the chart plotter: it is connected directly to the dedicated serial Port2.

To switch the internal Fish Finder transmission On follow the procedure:

- [MENU] + "Advanced Options" + [ENTER] + "Input/Output" + [ENTER] + "FF Transmission" + [ENTER] + "On" + [ENTER]

**NOTE** *It is not possible to connect any external Fish Finder unit to the chart plotter.*

## 5.2 UNDERSTANDING THE FISH FINDER PAGE

The display on chart plotters shows a history of time of the echoes received by the transducer. The chart plotters have a menu that allows adjustments to receiver sensitivity, depth range and scrolling speed of the Fish Finder display.

- ① Warning message
- ② Echogram window
- ③ Color Bar
- ④ Digital Depth
- ⑤ Water temperature
- ⑥ Alarm Bar
- ⑦ Depth ruler
- ⑧ Variable Depth Marker (VDM)
- ⑨ Zoom Bar
- ⑩ A-Scope
- ⑪ Operating Frequency

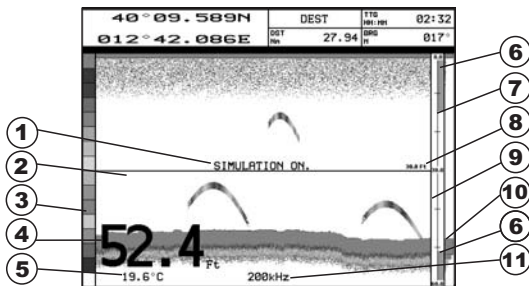

Fig. 5.2 - The Fish Finder page

The following is a short description of terms listed in the previous Fig. 5.2:

- ① **Warning Message**  
Flashing label "Simulation" when the echo sounder is in Simulation mode.
- ② **Echogram window**  
Graphic presentation of sonar soundings recorded as a continuous profile scrolling across the screen from right to left. Such recordings represent the image of the water beneath your boat, items appear as they pass under your transducer; the items on the right side of the screen are closer to you than those on the left. The correct interpretation of the Echogram allows retrieving useful information about what is under the boat. See the following Par. 5.2.2 for more information.
- ③ **Color Bar**  
Colored scale located on the left side of the screen that shows the colors used in the Echogram to represent the echoes strength. The color on the top of the bar represents the maximum sonar strength, while the color on the bottom of the bar represents the minimum sonar strength.
- ④ **Digital Depth**  
Readout of the current bottom depth.
- ⑤ **Water Temperature**  
Readout of the current water temperature returned by the TEMP 1 sensor included into specific transducers.
- ⑥ **Alarm Bar**  
Bar located on the right side of the Depth Ruler, showing the shallow water and deep water alarm values. The alarm is triggered when depth is outside the range.
- ⑦ **Depth Ruler**  
Vertical graduated bar located along the right side of the screen. It is a scale which reflects the depth of the area being displayed.

- ⑧ **Variable Depth Marker (VDM)**  
Horizontal line on to the Echogram window with a depth label. The up/down cursor keys can move it up and down. The label displays the depth of the cursor position. It can be moved to any location pinpointing the depth of a target.
- ⑨ **Zoom Bar**  
Bar located on the left side of the Depth Ruler, showing the portion of the Echogram currently represented in the zoomed window (on the left part of the screen). It is turned On selecting the Echo Sounder Split page.
- ⑩ **A-Scope**  
A real time representation of fish and bottom features passing through the beam of the transducer. It is drawn as horizontal lines whose length and hue is proportional to the sonar strength returned. When the default palette is selected, the strongest sonar returns will be shown as the color displayed of the top of Color Bar while the weakest as the bottom color.
- ⑪ **Operating Frequency**  
Readout of the selected operating frequency.

### 5.2.1 Understanding the Echogram display

The main elements that can be easily distinguished into an Echogram are:

- ① Fishes
- ② Thermoclines
- ③ White Line
- ④ Surface Clutter
- ⑤ Structures
- ⑥ Bottom Echo Profile

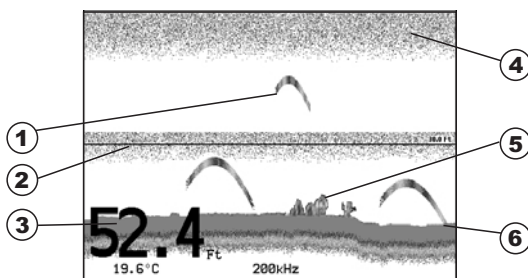

Fig. 5.2.1 - The Fish Finder Echogram

- ① **Fishes**  
Fishes are represented as arcs because of the cone angle of the transducer. In fact as the boat passes over the fish the leading edge of the cone strikes the fish, causing a display pixel to be turned on. As the boat passes over the fish, the distance to the fish decreases turning each pixel on at a shallower depth on the display. When the boat is directly over the fish, the first half of the arch is formed and since the fish is closer to the boat, the signal is stronger and the arch is thicker. As the boat moves away from the fish, the distance increases and the pixels appear at progressively deeper depths forming the remaining half of the arch.
- ② **Thermoclines**  
Are the zones where two layers of different water temperatures meet. The greater the temperature differential, the thicker the thermocline is shown on the screen. Thermoclines are represented as horizontal stripes of noise. They are very important for fishing since often many species of game fish like to suspend in, just above, or just below the thermoclines.

**3 White Line**

The White Line shows the difference between hard, soft bottoms and even distinguishes between fishes and structures located near the bottom. In this way it is easier to tell the difference between a hard and soft bottom and even to distinguish fishes and structures located nearby the bottom. For example, a soft, muddy or weedy bottom returns a weaker echo that is shown with a narrow white line while a hard bottom returns a strong echo that causes a wide white bottom line.

**4 Surface Clutter**

Appears like noise at the top of the screen extending many feet below the surface. It's caused by many things, including air bubbles, bait fish, plankton and algae.

**5 Structures**

Generally, the term "structure" is used to identify objects like wrecks and weeds rising from the bottom.

**6 Bottom Echo Profile**

Bottom profile recorded by the Fish Finder. When the echo sounder is set in auto-range mode it is automatically kept in the lower half of the screen.

**Other Elements**

Large anchoring cables are returned by the echo sounder as very long and narrow arcs on the screen.

### 5.3 DISPLAYING THE FISH FINDER PAGE

This section will take you through the frequently used operations and assist you to customize the look of the chart plotter using the Fish Finder.

#### 5.3.1 How to select the Fish Finder page

The Page Selection menu allows you to change the Fish Finder page displayed. To access this menu:

- [PAGE] + "Fish Finder" + [ENTER]

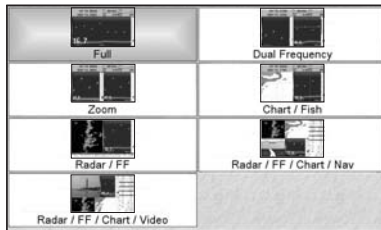

Fig. 5.3.1 - Example of Fish Finder Page selection on SW701ce

The menu now shows the selections related to the Fish Finder. Move the cursor to select the desired item and then press [ENTER].

#### Selection by Soft Key

Any soft key can be assigned any of the Fish Finder pages (see Par. 1.1). In the picture below, the four soft keys are customized to select any Fish Finder pages:



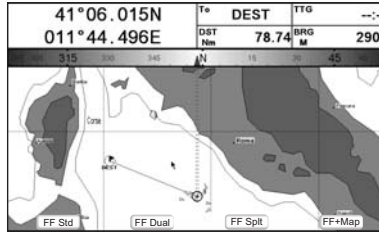

Fig. 5.3.2 - Example of Fish Finder page selection using Soft Keys

### 5.3.2 Fish Finder Full page

To display the Fish Finder Full Page Echogram, follow this procedure:

- [PAGE] + "Fish Finder" + [ENTER] + "Full" + [ENTER]

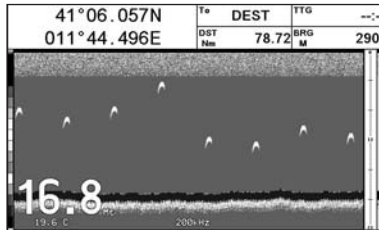

Fig. 5.3.2 - Example of 200kHz Fish Finder Full page

**NOTE** The frequency displayed depends on the selection done in the Frequency item (see Par 5.6.7).

#### The MENU key

Pressing [MENU] activates the Fish Finder Setup menu (see Par. 5.6). Pressing [MENU] subsequent times toggles between the Fish Finder Setup menu and the Functions menu.

#### The Cursor key

Moving the Cursor key up/down adjusts the Variable Depth Marker (VDM) up or down on the screen.

#### The ENTER key

Pressing [ENTER] activates the Sensitivity menu (see Par. 5.6.9) that allows tuning the Gain, the Surface Noise Filter and the STC.

Sensitivity	
Gain	0 %
STC	Off
STC Length	0 Mt
STC Strength	0 %
Surf Noise Filter	Off

Fig. 5.3.2a - Sensitivity sub-menu

Pressing [CLEAR] turns off the Sensitivity menu.

### The CLEAR key

By pressing **[CLEAR]** the Variable Depth Marker (VDM) is hidden.

### The ZOOM IN and ZOOM OUT keys

From this page pressing **[ZOOM IN]** once changes to Zoom 2X, pressing **[ZOOM IN]** twice changes to Zoom 4X, while pressing **[ZOOM OUT]** reverts to Zoom 2X and no zoom.

## 5.3.3 Dual Frequency page

To display the Fish Finder Dual Echogram, follow this procedure:

- **[PAGE]** + "Fish Finder" + **[ENTER]** + "Dual Frequency" + **[ENTER]**

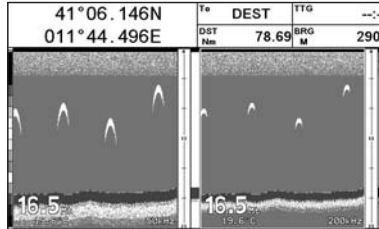

Fig. 5.3.3 - Fish Finder Dual Frequency mode

### The Cursor key

Moving the cursor to the right or the left moves the Variable Depth Marker (VDM) between the 50 and 200kHz displays. Moving the cursor up or down will move the VDM up and down. Press **[CLEAR]** to hide the VDM.

### The ZOOM IN and ZOOM OUT keys

From this page pressing **[ZOOM IN]** once changes to Zoom 2X, pressing **[ZOOM IN]** twice changes to Zoom 4X, while pressing **[ZOOM OUT]** reverts to Zoom 2X and no zoom.

## 5.3.4 Zoom page

To display the zoomed Fish Finder page on the left half of the screen and the unzoomed Fish Finder Echogram on the right half of the screen, follow this procedure:

- **[PAGE]** + "Fish Finder" + **[ENTER]** + "Zoom" + **[ENTER]**

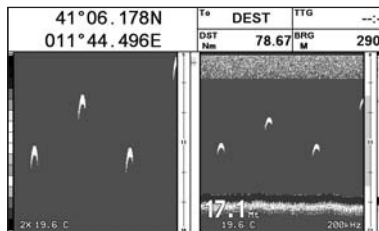

Fig. 5.3.4 - Fish Finder Zoom Page

The Depth Cursor is shown only on the unzoomed Fish Finder Echogram.

### The ZOOM IN and ZOOM OUT keys

When in this page pressing **[ZOOM IN]** changes to Zoom 4X, pressing **[ZOOM OUT]** changes to Zoom 2X.

### 5.3.5 Chart/Fish page

To display the Chart page on the left half of the screen and the Fish Finder Echogram on the right half of the screen, follow this procedure:

- [PAGE] + "Fish Finder" + [ENTER] + "Chart/Fish" + [ENTER]

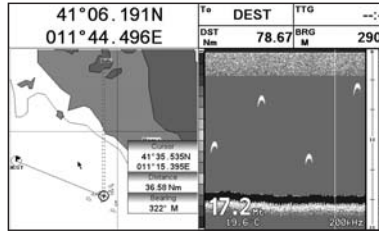

Fig. 5.3.5 - Fish Finder Chart/Fish page

#### The MENU key (to change the active window)

When in Chart/Fish mode pressing [MENU]:

- ◆ if the focus (the active window) is on the Chart, the Functions menu is shown. Pressing again [MENU] opens the Fish Finder Setup menu and moves the focus to the Fish Finder.
- ◆ if the focus (the active window) is on the Fish Finder, the Fish Finder Setup menu is shown. Pressing again [MENU] opens the Functions menu and moves the focus to the Chart.

**NOTE** When focus is on the Chart page, all keys work in cartography standard mode.

SW701ce/SW701ci:

### 5.3.6 Fish Finder and Radar pages

To display the Radar page on the left half of the screen and the Fish Finder Echogram on the right half of the screen, follow this procedure:

- [PAGE] + "Fish Finder" + [ENTER] + "Radar/FF" + [ENTER]

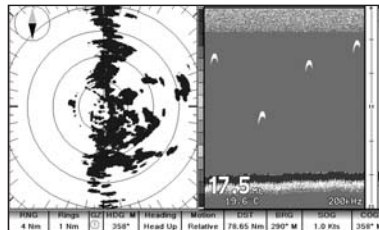

Fig. 5.3.6 - Radar/FF page

Otherwise to display the Radar and Fish Finder Combo pages, follow this procedure:

- [PAGE] + "Fish Finder" + [ENTER] + "Radar/FF/Chart/Nav" + [ENTER]

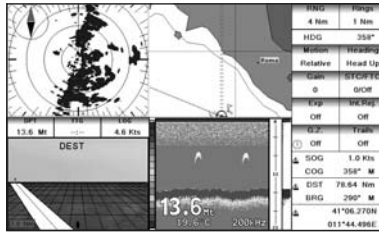

Fig. 5.3.6a - Radar/FF/Chart/Nav page

The other Fish Finder Combo page has the Video window instead of the Navigation window:

- [PAGE] + "Fish Finder" + [ENTER] + "Radar/FF/Chart/Video" + [ENTER]

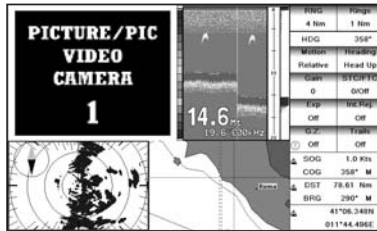

Fig. 5.3.6b - Radar/FF/Chart/Video page

When in Split/Combo pages, the active view is highlighted by a focus (Yellow frame). The keyboard commands are related to that focused view. To move the focus press **[MENU]** twice.

## 5.4 ZOOM MODES

### 5.4.1 The Bottom Lock Zoom

The Bottom Lock Zoom mode is activated when the Fish Finder is in Auto Range or Bottom Lock mode (see Par. 5.6.3) and the Variable Depth Marker (VDM) is not displayed on the screen.

In Bottom Lock Zoom mode the Fish Finder Echogram is automatically moved up/down as to keep the Bottom Line always visible in the lower half of the screen.

**NOTE** *Moving the Cursor key up/down displays the Variable Depth Marker (VDM) switching the Fish Finder in Marker Zoom mode.*

### 5.4.2 The Marker Zoom

The Marker Zoom mode is activated either when the Fish Finder is in Manual Range mode (see Par. 5.6.3) or the Depth Cursor is displayed on the screen.

In Marker Zoom mode the Fish Finder Echogram position is controlled by moving the Variable Depth Marker (VDM) and pressing and holding **[ENTER]** for 1 second on the selected position. Moving the Variable Depth Marker (VDM) over the top or below the bottom of the screen, automatically moves up/down the current zoomed Echogram view and re-position the Variable Depth Marker (VDM) at the center of the screen.

**NOTE** *Pressing [CLEAR] hides the Depth Cursor and if the Fish Finder is in Auto Range or Bottom Lock mode switches into Bottom Lock Zoom mode.*

## 5.5 SOUNDER ADJUSTMENTS WITH SOFT KEYS

When the Fish Finder page is active, by pressing one of the soft keys, the main functions to adjust the Fish Finder are shown on the soft keys labels on the screen. The soft keys labels disappear by pressing **[CLEAR]**.

### The Gain Soft Key

By pressing **[Gain]** the Gain changes between Auto Gain and Manual Gain.

If Manual Gain, use the cursor left/right to adjust it: a bar with the % symbol is displayed on the screen above the **[Gain]** label.

If Auto Gain, use the cursor left/right to adjust the Gain Offset: a bar with the % symbol is displayed on the screen above the **[Gain]** label.

### The STC Soft Key

The **[STC]** changes the STC value between Off/Short/Mid/Long/Custom. The current value of STC is shown on a window right over the **[STC]** label.

### The Range Soft Key

By pressing **[Range]** the window switches to the next Range status: Manual, Bottom Lock and Auto.

If Manual, use the cursor up/down to adjust the Depth value by 10Ft time and use the cursor left/right to adjust the Shift. When in meters the step is 2m and it increases to 10m when the key is pressed for more than 1 second.

If Bottom Lock, use the cursor up/down to adjust the Bottom Range value by 10Ft at a time. If Auto Range, the range value is set automatically and it cannot be changed by the user.

### The Freq Soft Key

Pressing **[Freq]** selects the Frequency to which the Sensitivity parameters are applied.

This option is available in all Fish Finder pages except the Dual Frequency page.

### The Int.Rej. Soft Key

Pressing **[Int.Rej.]** selects a filter to remove interference from other Fish Finders. This option is available only in the Dual Frequency page.

## 5.6 FISH FINDER SETUP MENU

The Fish Finder Setup menu provides access to additional functions, setup and layout/data field options. From the Fish Finder page, access this menu by pressing:

▶ **[MENU]**

Fish Finder Setup	
Preset Mode	Fish
Gain Mode	Manual
Range Mode	Manual
Depth	0.0 Mt
Shift	0.0 Mt
Bottom Range	0.0 Mt
Frequency	200 kHz
Interf Reject	Off
Sensitivity Menu	▶
Display Setup	▶
Transducer Setup	▶
Alarms	▶
Save & Load	▶

Fig. 5.6 - Fish Finder Setup menu

### 5.6.1 Preset Mode

Preset modes are pre-defined settings of the Fish Finder operating parameters. You can use them to quickly set the Fish Finder in the most commonly used operating modes. These are Cruise (sets the Fish Finder in full auto mode with the sensitivity settings optimized for displaying at best the bottom) and Fish (sets the Fish Finder in full auto mode with the sensitivity setting optimized for target searching). See the following table.

➤ [MENU] + "Preset Mode" + [ENTER]

---

<b>Fish</b>	: Gain Mode = Auto, Range Mode = Auto, Frequency = do not change, Shift = 0, STC = Short if Freq=200kHz and Mid if Freq=50kHz, Scrolling Speed = 10, Fish Symbols = Echo, A-Scope = On, Surface Noise Filter = Off.
<b>Cruise</b>	: Gain Mode = Auto, Range Mode = Auto, Frequency = do not change, Shift = 0, STC = Short if Freq=200kHz and Mid if Freq=50kHz, Scrolling Speed = 10, Fish Symbols = Echo, A-Scope = On, Surface Noise Filter = 4.

---

### 5.6.2 Gain Mode

Selects Auto or Manual.

➤ [MENU] + "Gain Mode" + [ENTER]

### 5.6.3 Range Mode

Selects among Manual, Auto Range and Bottom Lock. When in **Manual Range Mode** it is possible to set Shift (the offset from the surface) (see Par. 5.6.5) and Depth (see Par. 5.6.4) on which the Fish Finder shall operate. When in **Auto Range Mode** the Fish Finder determines automatically the range as to keep the bottom visible in the lower left of the screen. In this mode, Shift is always set to 0. In **Bottom Lock Mode** the Fish Finder automatically tracks the range around the bottom specified by the Bottom Range value.

➤ [MENU] + "Range Mode" + [ENTER]

### 5.6.4 Depth

This option is available only when Range Mode is Manual and it is disabled in Auto Range and Bottom Lock Mode.

➤ [MENU] + "Depth" + [ENTER]

### 5.6.5 Shift

This option is available only when Range Mode is Manual and it is disabled in Auto Range and Bottom Lock Mode.

➤ [MENU] + "Shift" + [ENTER]

**NOTE** *The bottom Range, Depth, Shift will apply to the currently selected frequency.*

### 5.6.6 Bottom Range

This option is available when Range Mode is Bottom Lock.

➤ [MENU] + "Bottom Range" + [ENTER]

### 5.6.7 Frequency

Allows you to choose the frequency between Auto, 50 kHz or 200 kHz when single frequency page is selected.

➤ [MENU] + "Frequency" + [ENTER]

### 5.6.8 Interference Rejection

Selects a filter to remove interference from other Fish Finders.

➤ [MENU] + "Interf Reject" + [ENTER]

### 5.6.9 Sensitivity Menu

The Sensitivity menu is accessible both from the Fish Finder Setup menu and by pressing **[ENTER]** when in Fish Finder pages. All settings in the Sensitivity menu are related to the Frequency selected.

➤ **[MENU] + "Sensitivity Menu" + [ENTER]**

<b>Frequency<sup>1</sup></b>	: <b>ONLY IN THE DUAL FREQUENCY PAGE</b> Allows you to select the Frequency to which the Sensitivity parameters are applied.
<b>Gain</b>	: Allows you to control the Gain of the unit's receiver. To see more details on the screen, increase the receiver sensitivity by selecting a higher gain percentage. If there is too much detail or if the screen is cluttered, lowering the sensitivity may increase the clarity of the display.
<b>STC</b>	: Sensitivity Time Constant: it is a time varying gain curve which attenuates the sonar receiver gain in shallow water, increasing the gain gradually as the depth increases. This is for the purpose of filtering out surface clutter.
<b>STC Length</b>	: If STC is Custom, it is possible to change the Length of the Sensitivity Time Constant.
<b>STC Strength</b>	: If STC is Custom, it is possible to change the Strength of the Sensitivity Time Constant.
<b>Surf Noise Filter<sup>2</sup></b>	: This function implements an advanced time varying filter that allows suppressing the surface clutter efficiently while leaving fish targets visible.

**NOTE<sup>1</sup>** *The Frequency value is only displayed: to select the desired frequency see the previous Par. 5.6.7.*

**NOTE<sup>2</sup>** *Thus imposing the capability of the Fish Finder to correctly detect the weakest echoes coming from a very deep bottom.*

### 5.6.10 Display Setup Menu

The Display Setup Menu allows you to change the color scheme of the Fish Finder display, adjusts the chart scrolling rate, enables or disables the White Line and allows determining the graphical representation of fishes.

➤ **[MENU] + "Display Setup" + [ENTER]**

<b>Color Settings</b>	: Allows you to change the color scheme of the Fish Finder display. The available colors are Blue Background, White Background, Black Background, Gray Scale and Reversed Gray Scale.
<b>Scrolling Speed</b>	: Adjusts the chart scrolling rate. Note that the scrolling rate is limited by the sound speed and the depth according with the following relation: the deeper the setting, the slower the scrolling rate. 100% is the maximum possible.
<b>White Line</b>	: Controls how the chart plotter displays information about the bottom type (hard or soft).
<b>Fish Symbols</b>	: Allows determining the graphical representation of underwater suspended targets: Echo/Echo+Icon/Echo+Icon+Depth/Echo+Depth/Icon/Icon+Depth. The Fish icons displayed are among four different shapes depending on the size of the Target (Small, Med, Big, Huge).
<b>Water Temperature</b>	: Allows you to choose the Water Temperature label displayed over the echogram between Primary and External.

### 5.6.11 Transducer Setup Menu

The Transducer Setup menu contains settings that does not require frequent changes.

➤ **[MENU] + "Transducer Setup" + [ENTER]**

<b>Keel Offset</b>	: It is the transducer depth offset from the surface. This makes it possible to measure depth from the surface instead of from the transducer's location.
<b>Calibrate Sound Speed</b>	: Allows calibrating the value of Sound Speed in the water, depending on the water temperature and salinity.
<b>Calibrate Water Speed</b>	: Allows calibrating the value of Water Speed sensor. The calibration value, in the range between -10% to +10%, will be applied to the water speed from the transducer.
<b>Calibrate Water Temperature</b>	: Allows the calibration on the Water Temperature sensor. Using the readings from a precise temperature measuring device, insert here a positive/negative offset to display right value on Fish Finder screens.
<b>Calibrate Aux Temperature</b>	: Allows the calibration of the Aux Temperature sensor. Using the readings from a precise temperature measuring device, insert here a positive/negative offset to display right value on FF screens.
<b>Restore Defaults</b>	: Restores the default values

### 5.6.12 Alarms Menu

The Alarms menu allows you to define additional sonar alarm settings for Fish Alarm, Shallow Alarm, Depth Alarm and Temperature Upper/Lower/Rate.

➤ [MENU] + "Alarms" + [ENTER]

---

<b>Shallow Water</b>	: Triggers an alarm when depth becomes shallower than the value set.
<b>Deep Water</b>	: Triggers an alarm when depth becomes deeper than the value set.
<b>High Water Temp</b>	: Triggers an alarm when the transducer reports a temperature (from TEMP 1 sensor) above the value set.
<b>Low Water Temp</b>	: Triggers an alarm when the transducer reports a temperature (from TEMP 1 sensor) below the value set.
<b>Water Temp Rate</b>	: Triggers an alarm when the transducer reports a temperature (from TEMP 1 sensor) variation rate above the value set.
<b>Fish Alarm</b>	: The options for Fish Alarm set the size of the fishes that, if detected by the unit, switches an alarm to sound. These options are: Off, Small, Medium, Big and Huge. The alarm sounds if the set size (or bigger) is detected.

---

### 5.6.13 Save & Load Menu

Insert the USER MEDIA into the slot, then follow the procedure:

➤ [MENU] + "Save & Load" + [ENTER]

---

<b>Load Settings from USER MEDIA</b>	: Load the complete settings from the USER MEDIA and changes the active menu settings.
<b>Save Settings to USER MEDIA</b>	: This is useful to avoid the user having to retune up Fish Finder after a Clear RAM operation or a software update.
<b>Restore Current Preset Defaults</b>	: Restores the default values only for the current presets (see Par. 5.6.1, Preset Mode) and does not affect the other presets.

---

## 5.7 TRANSDUCERS

The transducer is a device that transmits and receives sound waves into the water. The active component inside the transducer is commonly referred to as an element but actually is a piezoelectric ceramic material.

Please refer to your dealer and/or installer to choose your transducer. Seiwa suggest **AIRMAR** transducers.



# 6. GPS

---

For centuries, sailors have been searching for a reliable and precise method of travelling the world's waterways. From celestial navigating to the modern navigation techniques as Loran, Decca Navigator, Omega or Transit Satnav, each system has had its problems with weather, range and reliability. Without doubt, the "Global Positioning System", or GPS for short, is the most significant advance in navigation: it gives the navigator a position 24 hours a day, 365 days a year in any weather condition.

GPS is a satellite based navigation system which provides suitably equipped users with accurate position, velocity and time data.

Originally the GPS, developed by the U.S. Department of Defence, was conceived for military purposes, but now it is used in a host of civilian applications.

GPS navigation uses satellite signals to determine your position in relation to a set of satellites orbiting the earth. The GPS constellation of satellites continuously send radio signals, containing the precise position for each satellite back to earth. By knowing the position of 3 or 4 satellites and calculating various time differences between transmitted signals, the GPS receiver can determine its present position anywhere on earth, and thanks to continuous updates, calculate speed and course information.

## 6.1 HOW GPS WORKS

Currently, the GPS constellation consists of 26 orbiting satellites (including 3 spares), but this number will increase in the future.

The GPS receiver computes an accurate position by calculating the distance to the GPS satellites that orbit the earth. Signals are required from 3 satellites for two dimensional (2D) position calculation whilst 4 satellites are required for three dimensional (3D) position calculation.

As mentioned earlier, GPS satellites are not geostationary, but they are orbiting the earth as illustrated on the following figure:

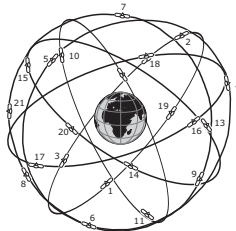

Fig. 6.1 - The GPS constellation

Note that position is repeatedly fixed through the following three steps while any 3 satellites are in line of sight.

The position calculation procedure is indicated in the following three steps:

1. GPS satellites continuously transmit their own precise orbital data and the GPS receiver computes their locations by receiving this data.
2. In this receiving process, the GPS receiver measures very accurate distances to the satellites, using the "Spread Spectrum Modulation"

method. Excellence in GPS's position-fixing accuracy is mainly due to this technology.

3. When the satellite locations and their distances are known, the GPS receiver fixes its own position by triangulation:

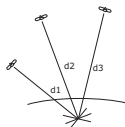

Fig. 6.1a - The GPS position calculation

As illustrated in the previous figure, the position is calculated as the meeting point of three spheres which are drawn around the three satellites with diameters  $d_1$ ,  $d_2$  and  $d_3$ .

### 6.1.1 Position Fixing Accuracy: HDOP

The GPS fix accuracy is due to the locations of 3 satellites in the sky. High accuracy is obtainable when the satellites are widely scattered in the sky; on the contrary, accuracy is reduced when the satellites have gathered in a narrow space. In the following figure, in both cases it is possible to obtain the GPS fix, but in the left case the accuracy will be higher than the right:

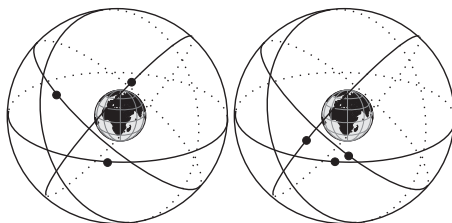

Fig. 6.1.1 - HDOP

The index for position-fixing accuracy is called HDOP (*"Horizontal Dilution Of Precision"*). The smaller the HDOP value, the more accurately the position can be fixed.

# 7. Maintenance

---

This chapter gives information on routine maintenance and problem solving associated with the chart plotter.

## 7.1 SYSTEM TEST

If you have connected your position-finding device according to the instructions, and chosen the proper menu selection for your device, and are still having problems with your chart plotter, the extended auto-test should help determine the problem. Make sure the chart plotter is turned Off. While pressing and holding any other key, turn the chart plotter On. A new menu will appear on the display. Use the cursor key to select the desired test: this will display in reverse video. To choose the test press **[ENTER]**. To exit from any submenu press **[CLEAR]**. To exit from the System Test turn Off the chart plotter.

### 7.1.1 RAM Menu

**RAM clear:** Clears internal memory. If the chart plotter exhibits unusual behaviour, or appears to be malfunctioning, it may be possible to correct the problem by clearing RAM. This operation will erase all Marks, Routes, stored Track plots and destinations. It will also return all selections (Input Data Format, Autopilot selection, etc.) to original default values. Before this step, you have the option of saving user Marks, Track history and Routes to a User MEDIA (this is an optional purchase from your dealer). To confirm to clear RAM press **[ENTER]** again (but if this time you do not wish to clear RAM press **[CLEAR]**).

### 7.1.2 DIM Menu

**Contrast:** Each time you press the cursor key to right, the screen will decrease brightness, when you press the left key the brightness will increase.

**Backlight:** Sets the backlight. It operates in similar mode as Contrast.

### 7.1.3 Media

**Data Base Test:** Tests the Worldwide Background.

**MEDIA Test:** Tests the MEDIA. There are four possible situations:

- ◆ If there is a MEDIA inserted in the slot and there is not a malfunction, the name of the MEDIA zone and the message "OK" are shown
- ◆ If there is a MEDIA inserted in the slot, but it is damaged MEDIA, the name of the MEDIA zone and/or the message "Faulty" are shown
- ◆ If there is not any MEDIA inserted in the slot, the message "not present" is shown
- ◆ If there is a USER MEDIA inserted in the slot, the message "USER MEDIA" is shown

**MEDIA Connector:** While a MEDIA is inserted in the slot, if the counter increases, there is a malfunction reading it.

### 7.1.4 Modem test

Checks the Modem connections. Press **[ENTER]** to select the desired Port related to the connections made, to the Port to which the Modem C-COM is connected.

### 7.1.5 Serial Ports

**Change parameters:** Changes the parameters of the serial interface. This menu allows to select the **Port** (Signal Source), the **Baud Rate** between 300 or 115200, the **Data Bits** (Word Length) between 7 or 8, the **Parity** between even, odd or none, the **Stop Bits** between 1 or 2.

**Input Data Display:** Allows the chart plotter to act as a computer terminal and display the incoming data exactly as it is received. If the data displayed on the screen is unrecognizable, you may have selected the wrong input parameters for your particular receiver. Check your receiver manual to be sure that you have selected the proper interface format. If the screen is blank, the connection may be interrupted, and no data is being received. Use **[PAGE]** to stop (or continue after pause) data displaying, **[ENTER]** to show data in hex or ASCII mode (normal or small) and **[CLEAR]** to exit.

**SW701e/SW701i/SW701ce/SW701ci/SW1101/SEAWAVE<sup>3</sup>/MARLIN/EXPLORER<sup>3</sup>:**

### 7.1.6 External Alarm

To check the External Alarm signal.

# Terms

---

- ♦ **ALT = Altitude**  
Altitude of GPS Antenna on the medium sea level.
- ♦ **Alter = Alternate Solution (TD Coordinates System)**  
Parameter selected by the user that is applied in the conversion of TD values to geographical coordinates Lat/Lon. It defines which of the two possible solutions can be used.
- ♦ **Arrival Time**  
Estimated time of day you will reach your destination, based on your current Speed and Track from GPS.
- ♦ **ASF = Additional Secondary phase Factor (TD Coordinates System)**  
Correction to TD values which can be inserted by the user.
- ♦ **Azimuth**  
Angular measurement from the horizon to a satellite or another object.
- ♦ **AWD = Apparent Wind Direction**  
Direction from which the Wind appears to blow relative to a moving point (also called Relative Wind Direction).
- ♦ **AWS = Apparent Wind Speed**  
Speed at which the Wind appears to blow relative to a moving point (also called Relative Wind Speed).
- ♦ **Beacon**  
A prominent, specially constructed object forming a conspicuous vertical mark as a fixed aid to navigation.
- ♦ **Buoy**  
A floating object moored to the sea bottom in a particular (charted) place, as an aid to navigation.
- ♦ **Buoys and Beacons**  
Buoys and Beacons are used to indicate to mariners recommended or established routes, underwater dangers, restrictions and regulations. They can be lighted or not and are colored according to their international code.
- ♦ **BRG = Bearing**  
Angle between the North (True or Magnetic) and a destination. The horizontal direction of one terrestrial point from another referring to the North (True or Magnetic). It is often used to indicate the direction to follow to reach the destination.
- ♦ **Chain (Loran-C GRI)**  
Groups of transmitting stations that use timed radio pulse transmissions. In each of these chains there is a master station and two or more slave or secondary stations. Stations belonging to a same chain transmit pulses in timing groups: a different time base identifies each chain. The time base of each chain is the Group Repetition Interval or GRI. This GRI identifies the chain in unique mode. For example the GRI = 4990 identifies the chain of Central Pacific zone.
- ♦ **COG = Course Over Ground**  
Direction of the path over ground actually followed by a vessel.
- ♦ **Course Line (Time Line)**  
Graphical indication of the direction in which the Vessel is heading. The Course Line origin is the vessel's position so the time line movement is synchronized with the vessels Icon. Course Line "course" is given by the value of COG

(Course Over Ground) and its length is proportional to the SOG (Speed Over Ground).

- ◆ **CTS = Course To Steer**

Optimum direction the boat should be steered in order to efficiently make headway back to the courseline while also proceeding toward the destination Waypoint.

- ◆ **Cultural Features**

Any man-made topographic feature as built-up area, buildings, roads.

- ◆ **Datum**

The Latitude and Longitude lines printed on any map are based on certain models of the shape of the earth: these models are called Datum or Coordinate Systems. There are many different Datum in use, each one gives different Lat/Lon positions for an identical point on the surface of the earth (see also Map Datum and Fix Datum).

- ◆ **Dead Reckoning**

Procedure to determine the current position of a vessel by applying to the last known position the way that has been made (since the last known position was received). This procedure is normally based on the last received GPS position, Speed and Course or to the last received GPS position, Log Speed and Heading.

- ◆ **Default**

Original factory setting for any menu selection. The default values are set after a Master Reset (RAM Clear).

- ◆ **Depth Area**

Sea areas included in the user selectable range of minimum and maximum depth limits. The sea area that is **beyond** the selected range is filled by a uniform white color, the sea area that is **inside** the selected range is filled by ordinary multicolor shading. The Spot Soundings and Depth Contours are displayed on the range only.

- ◆ **Depth Line**

(Also called Bathymetric Line) Imaginary line connecting points of equal water depth.

- ◆ **Destination**

In order to tag on the chart the point, towards which the ship is Heading, you can use a special mark, called destination. When the destination is placed, all navigation data referred to this point.

- ◆ **DGPS = Differential GPS**

Provides even greater positioning accuracy than standard GPS.

- ◆ **DPT = Depth from Transducer**

Water Depth below the Transducer. The Distance from the Depth Transducer to the ground.

- ◆ **DST = Distance**

Geographical distance between two points on the map. It is possible to select the unit among Nm, Sm and Km.

- ◆ **ETA = Estimated Time of Arrival**

Predicted time of reaching a destination or Waypoint

- ◆ **File**

Collection of information (of the same type) stored on a USER MEDIA. Each file must have a unique name, ideally one that describes its contents. Filenames are kept in a directory on each USER MEDIA.

- ◆ **Fix**

Current position of the vessel provided by the GPS (connected to the chart plotter or built-in) or other positioning systems.

- ◆ **Fix Status**  
Indicates the quality of the position fix signal.
- ◆ **Fuel Consumption Rate**  
Estimated fuel consumption rate (per hour) of an engine boat referred to its relative estimated cruising speed.
- ◆ **GNSS = Global Navigation Satellite System**  
Any single or combined navigation system based on satellites. The current available satellites systems are: GPS, GLONASS and the combined GPS and GLONASS.
- ◆ **Goto**  
Function that defines the destination point and activates the navigation to it. The destination can be placed on any location of the map, an existing Mark point or on a predefined Route.
- ◆ **GPS = Global Positioning System**  
Satellite based navigation system operated by the US Department of Defence. It gives the navigator a position 24 hours a day, 365 days a year under any weather conditions.
- ◆ **HDG = Heading**  
Horizontal direction in which a ship actually points or heads in any moment (see also COG).
- ◆ **HDOP = Horizontal Dilution Of Precision**  
Precision of the positioning system (GPS). The smaller HDOP value indicates higher position accurately.
- ◆ **Home mode**  
All operations refer to the ship's position.
- ◆ **Landmarks**  
Landmarks are any prominent object such as monument, building, silo, tower, mast, ..., on land which can be used in determining a location or a direction.
- ◆ **Latitude**  
Angular distance North or South of the equator measured by lines encircling the earth parallel to the equator in degrees from 0° to 90°.
- ◆ **LAT/LON**  
Coordinate system using Latitude and Longitude coordinates to define a position on earth.
- ◆ **Lat/Lon Grid**  
Grid of parallels (of Latitude) and meridians (of Longitude) drawn on the map.
- ◆ **LOG Speed**  
Speed of the vessel relative to the water, provided by an instrument with a submerged transducer for measuring the distance/speed travelled by the vessel.
- ◆ **Longitude**  
Angular distance East or West of the prime meridian (Greenwich meridian) as measured by lines perpendicular to the parallels and converging at the poles from 0° to 180°.
- ◆ **Loran**  
Positioning system which determines the current position of the vessel by measuring the difference in the times of reception of synchronized radio pulse signals transmitted by two or more fixed stations.
- ◆ **Magnetic Deviation**  
Value, expressed in degrees East or West that indicates the direction in which the north indicator on the compass card is offset from the magnetic north (the difference expressed in degrees East or West between the compass north and the magnetic north).
- ◆ **Magnetic Variation**  
Angle between the magnetic and geographic meridians at any place, expressed

in degrees West or East to indicate the direction of magnetic North from true North. It changes from point to point, and (at the same point) with time.

- ♦ **Mark**

Reference point related to cursor position. Typically it represents by an icon and label under Mark.

- ♦ **Natural Features**

Any topographic feature formed by the action of natural processes: coastlines, relief, glaciers.

- ♦ **Navigate mode**

Operating mode (called also Home mode): all operations refer to the ship's position. Navigate or Navigation mode is also used to indicate that the destination is placed.

- ♦ **NMEA-0183**

The NMEA-0183 Data Interface Standard was developed by the National Marine Electronics Association of America. It is an international standard that enables equipment from many different manufactures to be connected together and share information.

- ♦ **OSGB = Ordnance Survey of Great Britain**

Coordinate system describing only Great Britain charts. Generally used with GBR36 datum, which also describes only Great Britain charts. This coordinate system cannot be used in any other part of the world.

- ♦ **Pair**

The two selectable secondary stations, of a Loran-C chain, which are used to calculate the TD (Time Difference) position of a point in the map area covered by the selected Loran-C chain.

- ♦ **Pictures & Diagrams**

The MAX data format allows assigning one or more image to any cartographic object. These *Pictures* are typically used to facilitate the identification of cartographic objects or places around the map: they can be the landscape layout nearby a harbour, the shape of a bridge or of a buoy etc. On some objects, such as bridges, the image associated can represent the *Diagram* representing the shape of the objects and the various characteristics (length, height, type of bridge etc.).

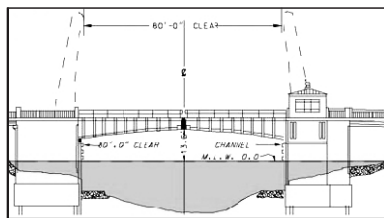

- ♦ **Port Info**

Port Info function is a combination of a Port Info database containing all the relevant Safety and Navigational information normally found in good pilot books and a presentation software which displays special Port Facility Symbols.

- ♦ **Ports & Services**

Areas along shore with facilities for mooring, downloading and uploading of ships, generally sheltered from waves and winds. Port installations are piers, wharves, pontoons, dry docks, cranes... .

- ♦ **Route**

Sequence of Waypoints connected by segments (Route Legs). Among the available Routes, only one is the Active Route, which is shown by a straight line and



- arrows to indicate the direction.
- ◆ **RTCM = Radio Technical Commission for Maritime Services**  
Data format created by the Radio Technical Commission Maritime to transmit Differential GPS corrections.
  - ◆ **SCALE**  
Allows the display of Map Scale (magnitude of the reference scale expressed in the actual unit of measure) and the current Map Datum.
  - ◆ **SNR = Signal to Noise Ratio**  
Ratio between the magnitude of a radio signal and the magnitude of the noise (that is, the interferences). The SRN is expressed in decibels and it is associated to the GPS satellites signal quality.
  - ◆ **SOG = Speed Over Ground**  
Current velocity at which the vessel is travelling, relative to a ground location. The SOG is normally provided by the GPS sensor.
  - ◆ **Spot Sounding**  
Depth of the water in a specific and charted position. It is represented on the map by its own value expressed in the current depth unit.
  - ◆ **STR = Steering**  
Difference between COG and CTS. If COG is 25° and CTS is 30°, then STR is 5° Right.
  - ◆ **STW = Speed Through Water**  
Speed of the vessel relative to the water.
  - ◆ **TD = Time Difference**  
Loran positions are determined by precise timing of the intervals between reception of pulses transmitted by pairs of stations in the selected chain. Between any two stations a ship must be located somewhere along a line of possible positions where the measured Time Difference, TD, between arrival of pulses from those stations would be observed. The TD is measured from the time of reception of the master station signal to the time of reception of the slave station signal (see also Pair).
  - ◆ **Tide**  
Periodic rise and fall of the surface of oceans, bays, etc., due principally to the gravitational interactions between the Moon and Earth.
  - ◆ **Tide Info**  
Calculates the tide heights for any past or future date and as a by-product of this calculation will also display the Maximum and Minimum Tide height and time for the day selected plus the times of Sunrise and Sunset. At some chart levels, the chart plotter will display a new Tide Diamond Symbol for every Port or tide point in the database covered by that particular DATA MEDIA.
  - ◆ **Tracks & Routes**  
Recommended and established routes for ships at sea, including traffic separation schemes, deep water routes.
  - ◆ **TRN = Turning**  
Difference between COG and BRG. If COG is 80° and BRG is 75°, TRN is 5° Left.
  - ◆ **TTG = Time To Go**  
Estimated time needed to reach your destination, based on your current speed and the distance to destination.
  - ◆ **TWD = True Wind Direction**  
Direction of the Wind relative to a fixed point on the earth.
  - ◆ **TWS = True Wind Speed**  
Velocity of the Wind relative to a fixed point on the earth.
  - ◆ **Underwater Objects**  
Objects like obstruction, wreck, cable...

- ◆ **User Point**  
Object you place on the chart identified by its coordinates and displayed on the screen with a reference symbol (see Mark, Waypoint).
- ◆ **UTC = Universal Time Coordinated**  
Time scale based on the rotation of the earth that is used by most broadcast time services.
- ◆ **UTM = Universal Transverse Mercator**  
Metric Grid system used on most large and intermediate scale land topographic charts and maps.
- ◆ **Variation**  
Angle between the magnetic and geographic meridians at any place, expressed in degrees West or East to indicate the direction of magnetic North from true North. It changes from point to point, and (at the same point) with time.
- ◆ **VMG= Velocity Made Good**  
Destination closing Velocity. The VMG is calculated using the current speed of the vessel (SOG) and the difference between the current vessel course and the bearing to the destination.
- ◆ **WAAS = Wide Area Augmentation System**  
The Federal Aviation Administration (FAA), in cooperation with other DOT organizations and DOD, is augmenting the GPS/SPS with a satellite-based augmentation system, the WAAS. It will provide a signal-in-space to WAAS users to support en route through precision approach navigation. After achieving initial operational capability, the WAAS will then be incrementally improved over the next years to expand the area of coverage, increase the availability of precision approaches, increase signal redundancy and reduce operational restrictions.
- ◆ **Waypoint**  
Any point to which one intends to navigate. A sequence of Waypoints makes up a Route plan.
- ◆ **WGS-84 = World Geodetic System 1984**  
Coordinates System or Datum developed by the Defence Mapping Agency (DMA). It is the default geodetic Datum used by the chart plotter and the GPS.
- ◆ **Zoom-In**  
Shows more detail in a smaller area.
- ◆ **Zoom-Out**  
Operates similarly to zoom -in, but in the reverse, showing a wider but less detailed view.
- ◆ **XTE = Cross Track Error**  
Distance from the ship's present position to the closest point on a line between the origin and destinations Waypoints of the navigation.

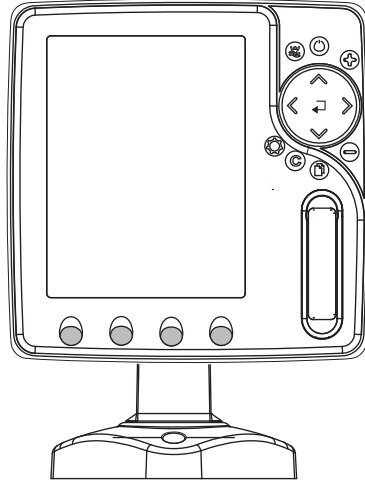

## FEATURES & FUNCTIONS

- ◆ Direct sunlight viewable color 5" LCD vertical display
- ◆ Worldwide Built-in Cartography showing C-MAP By JEPPESEN detail up to 2.0 NM
- ◆ "C-MAP By JEPPESEN" MAX electronic charts, object-oriented chart system with enhanced functionality including:
  - Guardian alarm, Safety Status Bar, Safe Route Checking
  - Perspective View
  - Satellite Image Coverage
  - Turbo and Smooth Zoom
  - Multilanguage
  - Enhanced Port Information database
  - Tides & Currents data
  - Photos & Diagrams
  - Automatic Information on all chart objects and User Points
  - Find function for Ports Services, Ports By Name, Ports By Distance, Tide Stations, Wrecks, Obstructions, Lakes Information, Lakes By Name, Points Of Interest, Cursor, Coordinates and User Points
- ◆ Positional information from GPS
- ◆ Depth Graph pages
- ◆ Navigation Data page
- ◆ 3D Road page
- ◆ GPS Status page
- ◆ Gauges pages
- ◆ AIS Report List page
- ◆ Fish Finder pages<sup>1</sup>
- ◆ 5000 Waypoints/Marks and 25 Routes (5000 Waypoints max per Route)

- ◆ 5000 Track Points
- ◆ Create, Move, Insert, Edit, Delete, Send, Receive Waypoint
- ◆ Create, Move, Edit, Delete, Send, Receive Mark/Event
- ◆ Navigation to Goto
- ◆ Create, Save, Name, Edit, Delete, Send, Receive or Follow a Route
- ◆ Route Data Report and User Points (Marks/Waypoints) List pages
- ◆ Display vessel's position, direction and Track
- ◆ Alarms Handling (Auto Off, Arrival Alarm, XTE Alarm, Anchor Alarm, Depth Alarm, HDOP Alarm, Heading Alarm, Grounding Alarm)
- ◆ Man OverBoard (MOB) to navigate back to a missing person or object
- ◆ C-Link and C-Weather Service
- ◆ R-B function
- ◆ Simulation Mode with cursor control

**NOTE<sup>1</sup>** *If Fish Finder connected.*

## TECHNICAL SPECIFICATIONS

- ◆ Operating Voltage : 10 - 35 Volt dc
- ◆ Power consumption : 0.6A max @ 12V (7.2W Max)
- ◆ Interface : NMEA-0183
- ◆ Autopilot Interface : NMEA-0180, NMEA-0180/CDX, NMEA-0183
- ◆ Display : Sun Light Viewable Color LCD (*active area 5"*)
- ◆ Display Resolution : 240 x 320 pixels
- ◆ MEDIA : SD Card
- ◆ Cartography : C-MAP BY JEPPESEN DATA MEDIA
- ◆ Operating temperature range : 32/131 °F (0/+55 °C)
- ◆ Memory : Non volatile
- ◆ Keyboard : Silicon rubber, backlight
- ◆ Weight : 580 gr. (sw501i)  
560 gr. (sw501e)

When the package containing the chart plotter is opened for the first time after purchase, please make sure that the following contents are present (if any item is missing, please contact your local dealer):

- ◆ Quick Disconnect Bracket
- ◆ Chart plotter's protective cover
- ◆ Fuse 2 Amp. + fuseholder
- ◆ User Manual
- ◆ Flush mounting kit (OPTIONAL) + Cutting template (sw501e)
- ◆ Smart DGPS WAAS Receiver with cable 15 mt/45 feet (sw501e)

## INSERTING/REMOVING PROCEDURE

### Inserting the MEDIA

Open the door. Hold the MEDIA by the short side. Gently push the MEDIA into the slot; press the MEDIA in as far as it will go to hold fixed into the slot.

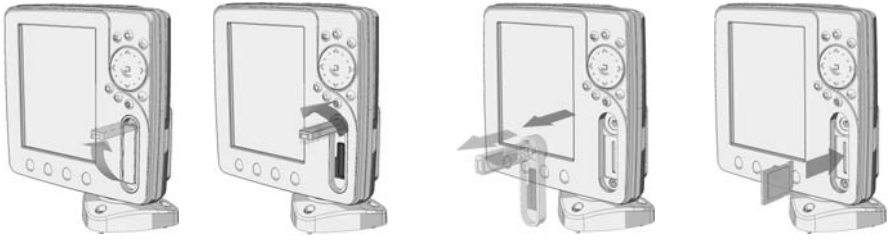

## Removing the MEDIA

Open the door, press in on the MEDIA and remove the MEDIA out of the slot.

## CHART PLOTTER DIMENSIONS

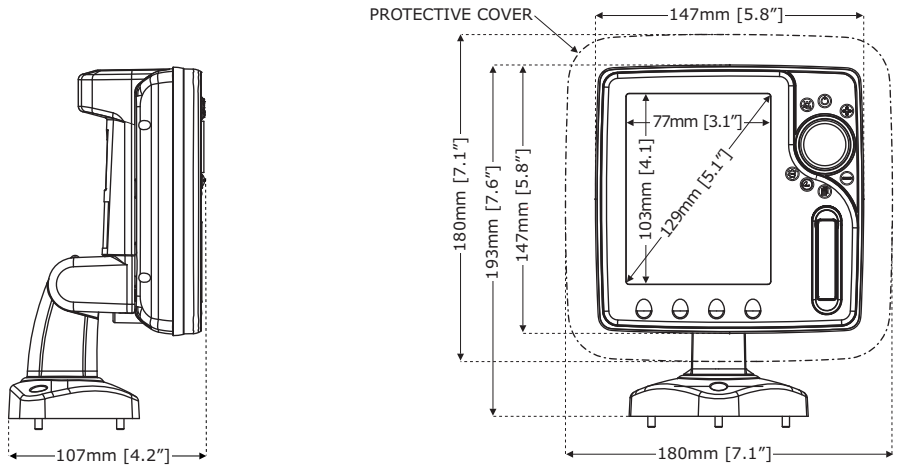

## INSTALLATION AND REMOVING

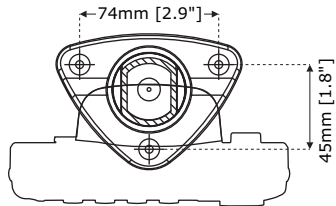

Bracket installation

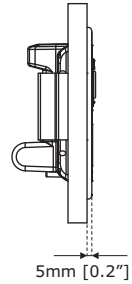
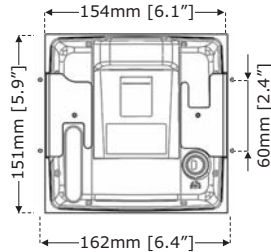
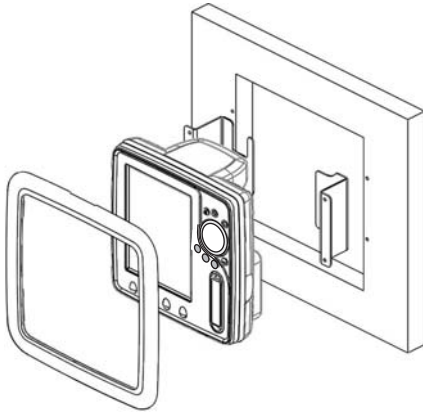

Flush mount installation

## EXTERNAL WIRING

QUICK DISCONNECT BRACKET CABLE		
WIRE COLOR	DESCRIPTION	FUNCTION
BLACK	GND/COMMON	POWER SUPPLY GND
RED	POWER+ 10-35Vdc	POWER SUPPLY+
WHITE	INPUT 1+	NMEA0183/C-COM
GREEN	SIGNAL RETURN-	SIGNAL RETURN
YELLOW	OUTPUT 1+	NMEA0183/180/180CDX/C-COM
BROWN	INPUT 2+	NMEA0183/C-COM
GRAY	OUTPUT 2+	NMEA0183/180/180CDX/C-COM
ORANGE	INPUT 3+ (*)	NMEA0183/C-COM
PINK	OUTPUT 3+ (*)	NMEA0183/180/180CDX/C-COM
BLUE	SIGNAL RETURN-	SIGNAL RETURN

(\*) Available on Chart Plotter with External GPS

External Wiring

## TYPICAL CONNECTIONS

QUICK DISCONNECT BRACKET CABLE		
WIRE COLOR	DESCRIPTION	FUNCTION
BLACK	GND/COMMON	POWER SUPPLY GND
RED	POWER +10-35Vdc	POWER SUPPLY+
WHITE	INPUT1+	NMEA0183/C-COM
GREEN	SIGNAL RETURN-	SIGNAL RETURN
YELLOW	OUTPUT1+	NMEA0183/180/180CDX/C-COM
BROWN	INPUT2+	NMEA0183/C-COM
GRAY	OUTPUT2+	NMEA0183/180/180CDX/C-COM
ORANGE	INPUT3+	NMEA0183/C-COM
PINK	OUTPUT3+	NMEA0183/180/180CDX/C-COM
BLUE	SIGNAL RETURN-	SIGNAL RETURN

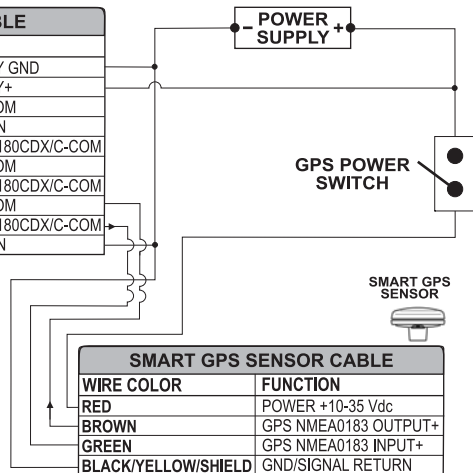

GPS Connection on Port 3 for SW501e

QUICK DISCONNECT BRACKET CABLE		
WIRE COLOR	DESCRIPTION	FUNCTION
BLACK	POWER GND	POWER SUPPLY GND
RED	POWER +10-35Vdc	POWER SUPPLY+
WHITE	INPUT1+	NMEA0183/C-COM
GREEN	SIGNAL RETURN-	SIGNAL RETURN
YELLOW	OUTPUT1+	NMEA0183/180/180CDX/C-COM
BROWN	INPUT2+	NMEA0183/C-COM
GRAY	OUTPUT2+	NMEA0183/180/180CDX/C-COM
ORANGE	INPUT3+	NMEA0183/C-COM
PINK	OUTPUT3+	NMEA0183/180/180CDX/C-COM
BLUE	SIGNAL RETURN-	SIGNAL RETURN

AUTOPILOT DEVICE	
FUNCTION	
NMEA0183/180/180CDX/INPUT+	
SIGNAL RETURN	

Autopilot Connection on Port 2

QUICK DISCONNECT BRACKET CABLE		
WIRE COLOR	DESCRIPTION	FUNCTION
BLACK	POWER GND	POWER SUPPLY GND
RED	POWER +10-35Vdc	POWER SUPPLY+
WHITE	INPUT1+	NMEA0183/C-COM
GREEN	SIGNAL RETURN-	SIGNAL RETURN
YELLOW	OUTPUT1+	NMEA0183/180/180CDX/C-COM
BROWN	NC	
GRAY	NC	
ORANGE	INPUT3+	NMEA0183/C-COM
PINK	OUTPUT3+	NMEA0183/180/180CDX/C-COM
BLUE	SIGNAL RETURN-	SIGNAL RETURN

NMEA0183 DEVICE	
FUNCTION	
NMEA0183 OUTPUT+	
NMEA0183 INPUT+	
SIGNAL RETURN	

External NMEA Connection on Port 1

## C-COM Connection

To connect the modem C-COM to the chart plotter with quick disconnect bracket follow the procedure:

1. Cut the C-COM cable about 5 cm from the "T" connector:

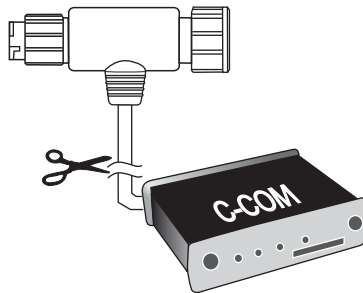

C-COM cable cutting procedure

2. Connect the wires to the quick disconnect bracket cable as follows:

QUICK DISCONNECT BRACKET CABLE		
WIRE COLOR	DESCRIPTION	FUNCTION
BLACK	POWER GND	POWER SUPPLY GND
RED	POWER +10-35Vdc	POWER SUPPLY+
WHITE	INPUT1+	C-COM
GREEN	SIGNAL RETURN-	SIGNAL RETURN
YELLOW	OUTPUT1+	C-COM

C-COM GSM Plus CABLE	
WIRE COLOR	FUNCTION
BLACK	GND
RED	POWER SUPPLY+
WHITE	C-COM TX+
GREEN	C-COM TX-
YELLOW	C-COM RX+



C-COM Connection on Port 1





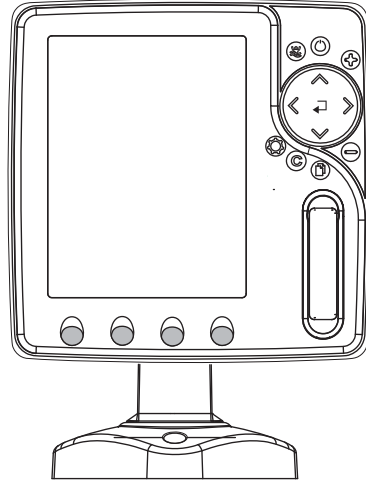

## FEATURES & FUNCTIONS

- ◆ Direct sunlight viewable color 5" LCD vertical display
- ◆ Worldwide Built-in Cartography showing C-MAP By JEPPESEN detail up to 2.0 NM
- ◆ "C-MAP By JEPPESEN" MAX electronic charts, object-oriented chart system with enhanced functionality including:
  - Guardian alarm, Safety Status Bar, Safe Route Checking
  - Perspective View
  - Satellite Image Coverage
  - Turbo and Smooth Zoom
  - Multilanguage
  - Enhanced Port Information database
  - Tides & Currents data
  - Photos & Diagrams
  - Automatic Information on all chart objects and User Points
  - Find function for Ports Services, Ports By Name, Ports By Distance, Tide Stations, Wrecks, Obstructions, Lakes Information, Lakes By Name, Points Of Interest, Cursor, Coordinates and User Points
- ◆ Positional information from GPS
- ◆ Depth Graph pages
- ◆ Navigation Data page
- ◆ 3D Road page
- ◆ GPS Status page
- ◆ Gauges pages
- ◆ AIS Report List page
- ◆ Fish Finder pages
- ◆ 5000 Waypoints/Marks and 25 Routes (5000 Waypoints max per Route)

- ◆ 5000 Track Points
- ◆ Create, Move, Insert, Edit, Delete, Send, Receive Waypoint
- ◆ Create, Move, Edit, Delete, Send, Receive Mark/Event
- ◆ Navigation to Goto
- ◆ Create, Save, Name, Edit, Delete, Send, Receive or Follow a Route
- ◆ Route Data Report and User Points (Marks/Waypoints) List pages
- ◆ Display vessel's position, direction and Track
- ◆ Alarms Handling (Auto Off, Arrival Alarm, XTE Alarm, Anchor Alarm, Depth Alarm, HDOP Alarm, Heading Alarm, Grounding Alarm)
- ◆ Man OverBoard (MOB) to navigate back to a missing person or object
- ◆ C-Link and C-Weather Service
- ◆ R-B function
- ◆ Simulation Mode with cursor control
- ◆ Internal Fish Finder

## TECHNICAL SPECIFICATIONS

- ◆ Operating Voltage : 10 - 35 Volt dc
- ◆ Power consumption : 12W average; 24W peak (with FF on)
- ◆ Interface : NMEA-0183
- ◆ Autopilot Interface : NMEA-0180, NMEA-0180/CDX, NMEA-0183
- ◆ Display : Sun Light Viewable Color LCD (*active area 5"*)
- ◆ Display Resolution : 240 x 320 pixels
- ◆ MEDIA : SD Card
- ◆ Cartography : C-MAP By JEPPESEN DATA MEDIA
- ◆ Operating temperature range : 32/131 °F (0/+55 °C)
- ◆ Memory : Non volatile
- ◆ Keyboard : Silicon rubber, backlight
- ◆ Weight : 700 gr. (SW501ci)  
680 gr. (SW501ce)

## FF MODULE 600W-50-200KHZ TECHNICAL SPECIFICATIONS

- ◆ Power Output : 600W (4800Wpp), 50/200KHz Dual Frequency
- ◆ Max Depth : 213m (700ft) at 200kHz, 457m(1500ft) at 50kHz
- ◆ Automatic Recognition of the AIRMAR "X-DUCER ID" transducers for best performance
- ◆ Advanced Digital Signal Processing
- ◆ Speed & Temperature Sensor (if available on transducer)
- ◆ Alarms (shallow water, depth, Fish, temp)
- ◆ Trip Log, Fish Symbols
- ◆ STC, Interference Rejection, Automatic noise reduction
- ◆ A-scope, White Line, Zoom x2/x4
- ◆ Auto range/gain/frequency/shift/ping rate

When the package containing the chart plotter is opened for the first time after purchase, please make sure that the following contents are present (if any item is missing, please contact your local dealer):

- ◆ Quick Disconnect Bracket
- ◆ Chart plotter's protective cover
- ◆ Fuse 3 Amp. + fuseholder
- ◆ User Manual
- ◆ Flush mounting kit (OPTIONAL) + Cutting template
- ◆ Smart DGPS WAAS Receiver with cable 15 mt/45 feet (SW501ce)

## INSERTING/REMOVING PROCEDURE

### Inserting the MEDIA

Open the door. Hold the MEDIA by the short side. Gently push the MEDIA into the slot; press the MEDIA in as far as it will go to hold fixed into the slot.

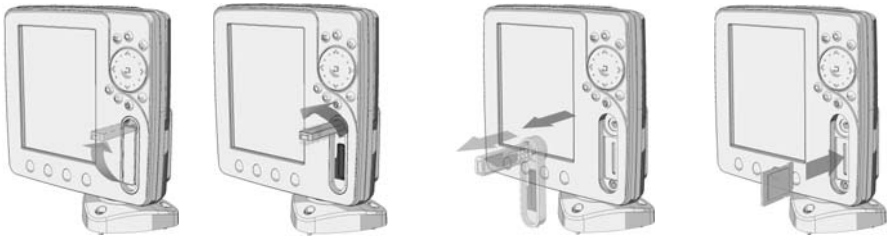

### Removing the MEDIA

Open the door, press in on the MEDIA and remove the MEDIA out of the slot.

## CHART PLOTTER DIMENSIONS

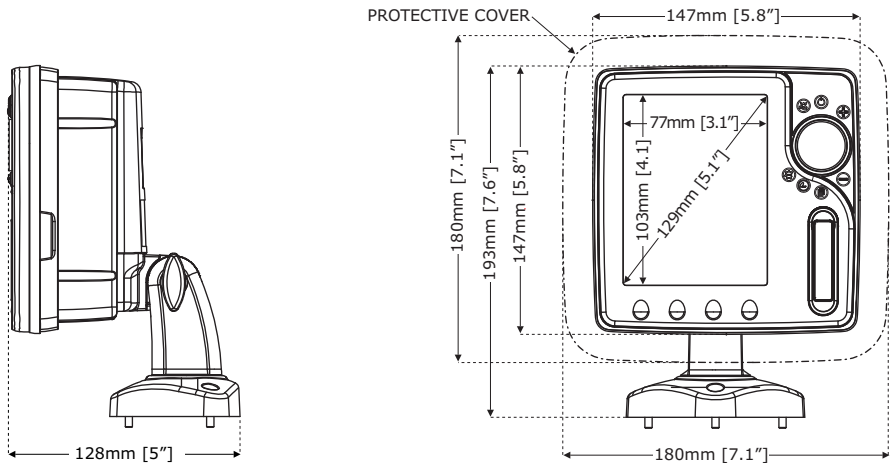

## INSTALLATION AND REMOVING

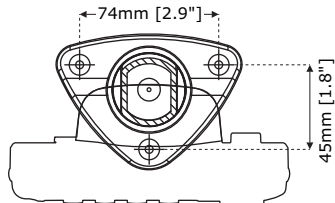

Bracket installation

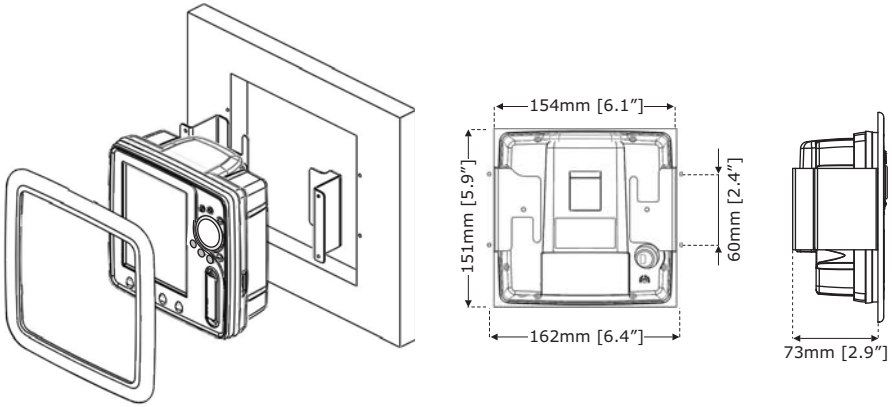

Flush mount installation

## EXTERNAL WIRING

QUICK DISCONNECT BRACKET CABLE		
WIRE COLOR	DESCRIPTION	FUNCTION
BLACK	GND/Common	POWER SUPPLY GND
RED	POWER +10-35Vdc	POWER SUPPLY+
WHITE	INPUT1+	NMEA0183/C-COM
GREEN	SIGNAL RETURN-	SIGNAL RETURN
YELLOW	OUTPUT1+	NMEA0183/180/180CDX/C-COM
BROWN	NC	
GRAY	NC	
ORANGE	INPUT3+ (*)	NMEA0183/C-COM
PINK	OUTPUT3+ (*)	NMEA0183/180/180CDX/C-COM
BLUE	SIGNAL RETURN-	SIGNAL RETURN

(\*) Available on Chart Plotter with External GPS

External Wiring

## TYPICAL CONNECTIONS

QUICK DISCONNECT BRACKET CABLE		
WIRE COLOR	DESCRIPTION	FUNCTION
BLACK	GND/Common	POWER SUPPLY GND
RED	POWER +10-35Vdc	POWER SUPPLY+
WHITE	INPUT1+	NMEA0183/C-COM
GREEN	SIGNAL RETURN-	SIGNAL RETURN
YELLOW	OUTPUT1+	NMEA0183/180/180CDX/C-COM
BROWN	NC	
GRAY	NC	
ORANGE	INPUT3+	NMEA0183/C-COM
PINK	OUTPUT3+	NMEA0183/180/180CDX/C-COM
BLUE	SIGNAL RETURN-	SIGNAL RETURN

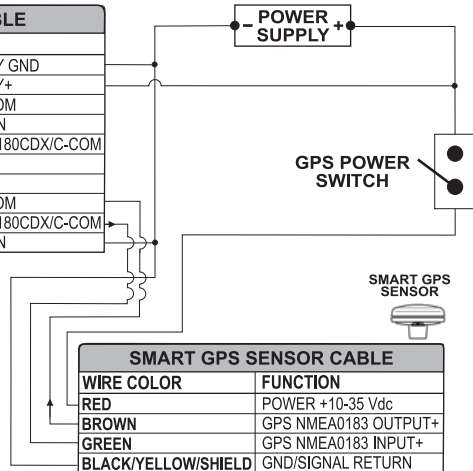

GPS Connection on Port 3 for SW501ce

QUICK DISCONNECT BRACKET CABLE		
WIRE COLOR	DESCRIPTION	FUNCTION
BLACK	POWER GND	POWER SUPPLY GND
RED	POWER +10-35Vdc	POWER SUPPLY+
WHITE	INPUT1+	NMEA0183/C-COM
GREEN	SIGNAL RETURN-	SIGNAL RETURN
YELLOW	OUTPUT1+	NMEA0183/180/180CDX/C-COM
BROWN	NC	
GRAY	NC	
ORANGE	INPUT3+	NMEA0183/C-COM
PINK	OUTPUT3+	NMEA0183/180/180CDX/C-COM
BLUE	SIGNAL RETURN-	SIGNAL RETURN

AUTOPILOT DEVICE	
FUNCTION	
NMEA0183/180/180CDX/INPUT+	
SIGNAL RETURN	

Autopilot Connection on Port 1

QUICK DISCONNECT BRACKET CABLE		
WIRE COLOR	DESCRIPTION	FUNCTION
BLACK	POWER GND	POWER SUPPLY GND
RED	POWER +10-35Vdc	POWER SUPPLY+
WHITE	INPUT1+	NMEA0183/C-COM
GREEN	SIGNAL RETURN-	SIGNAL RETURN
YELLOW	OUTPUT1+	NMEA0183/180/180CDX/C-COM
BROWN	NC	
GRAY	NC	
ORANGE	INPUT3+	NMEA0183/C-COM
PINK	OUTPUT3+	NMEA0183/180/180CDX/C-COM
BLUE	SIGNAL RETURN-	SIGNAL RETURN

NMEA0183 DEVICE	
FUNCTION	
NMEA0183 OUTPUT+	
NMEA0183 INPUT+	
SIGNAL RETURN	

External NMEA Connection on Port 1

## C-COM Connection

To connect the modem C-COM to the chart plotter with quick disconnect bracket follow the procedure:

1. Cut the C-COM cable about 5 cm from the "T" connector:

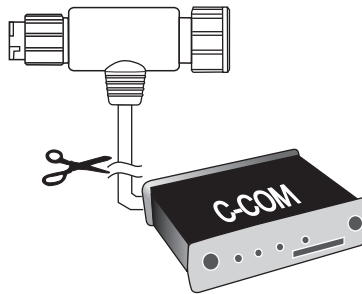

C-COM cable cutting procedure

2. Connect the wires to the quick disconnect bracket cable as follows:

QUICK DISCONNECT BRACKET CABLE		
WIRE COLOR	DESCRIPTION	FUNCTION
BLACK	POWER GND	POWER SUPPLY GND
RED	POWER +10-35Vdc	POWER SUPPLY+
WHITE	INPUT1+	C-COM
GREEN	SIGNAL RETURN-	SIGNAL RETURN
YELLOW	OUTPUT1+	C-COM

C-COM GSM Plus CABLE	
WIRE COLOR	FUNCTION
BLACK	GND
RED	POWER SUPPLY+
WHITE	C-COM TX+
GREEN	C-COM TX-
YELLOW	C-COM RX+



C-COM Connection on Port 1



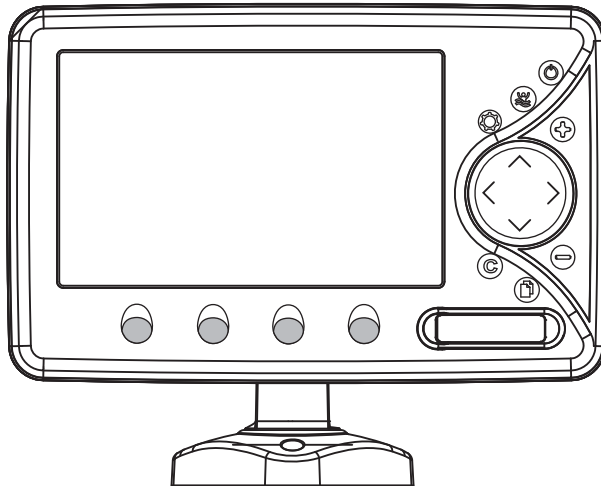

## FEATURES & FUNCTIONS

- ◆ Direct sunlight viewable color LCD 16/9 display WVGA (800x480) resolution
- ◆ Worldwide Built-in Cartography showing C-MAP By JEPPESEN detail up to 2.0 NM
- ◆ "C-MAP By JEPPESEN" MAX electronic charts, object-oriented chart system with enhanced functionality including:
  - Guardian alarm, Safety Status Bar, Safe Route Checking
  - Perspective View
  - Satellite Image Coverage
  - Turbo and Smooth Zoom
  - Multilanguage
  - Enhanced Port Information database
  - Tides & Currents data
  - Photos & Diagrams
  - Automatic Information on all chart objects and User Points
  - Find function for Ports Services, Ports By Name, Ports By Distance, Tide Stations, Wrecks, Obstructions, Lakes Information, Lakes By Name, Points Of Interest, Cursor, Coordinates and User Points
- ◆ Positional information from GPS
- ◆ Depth Graph pages
- ◆ Navigation Data page
- ◆ 3D Road page
- ◆ GPS Status page
- ◆ Wind Data page
- ◆ Gauges page
- ◆ DSC Log and DSC Directory pages
- ◆ AIS Report List page
- ◆ Fish Finder/Radar/Video Input pages<sup>1</sup>
- ◆ 10000 Waypoints/Marks and 50 Routes (10000 Waypoints max per Route)

- ◆ 10000 Track Points
- ◆ Create, Move, Insert, Edit, Delete, Send, Receive Waypoint
- ◆ Create, Move, Edit, Delete, Send, Receive Mark/Event
- ◆ Navigation to Goto
- ◆ Create, Save, Name, Edit, Delete, Send, Receive or Follow a Route
- ◆ Route Data Report and User Points (Marks/Waypoints) List pages
- ◆ Display vessel's position, direction and Track
- ◆ Alarms Handling (Auto Off, Arrival Alarm, XTE Alarm, Anchor Alarm, Depth Alarm, HDOP Alarm, Heading Alarm, Grounding Alarm, External Alarm)
- ◆ Man OverBoard (MOB) to navigate back to a missing person or object
- ◆ C-Link and C-Weather Service
- ◆ R-B function
- ◆ Simulation Mode with cursor control
- ◆ Video Input option

**NOTE<sup>1</sup>** *If Fish Finder/Radar/Video Camera connected.*

## TECHNICAL SPECIFICATIONS

- ◆ Operating Voltage : 10 - 35 Volt dc
- ◆ Power consumption : 10W average; 12W max *(the power consumption is measured with VCAM connected and active)*
- ◆ Interface : NMEA-0183
- ◆ Autopilot Interface : NMEA-0180, NMEA-0180/CDX, NMEA-0183
- ◆ Video Input : PAL or NTSC video signals automatically selected
- ◆ Display : Color Sunlight Viewable LCD *(active area 7")*
- ◆ Display Resolution : 800 x 480 pixels
- ◆ MEDIA : SD Card
- ◆ Cartography : C-MAP BY JEPPESEN DATA MEDIA
- ◆ Operating temperature range: 0/+55°C (32/+131°F)
- ◆ Memory : Non volatile
- ◆ Keyboard : Silicon rubber, backlight
- ◆ Weight : 1150 gr. (**SW701i**)  
1100 gr. (**SW701e**)

When the package containing the chart plotter is opened for the first time after purchase, please make sure that the following contents are present (if any item is missing, please contact your local dealer):

- ◆ Quick Disconnect Bracket
- ◆ AUX IN I/O cable 1,5 mt/5.9 feet
- ◆ Video Input cable
- ◆ Chart plotter's protective cover
- ◆ Fuse 3.15 Amp. + fuseholder
- ◆ User Manual
- ◆ Flush mounting kit (OPTIONAL) + cutting template
- ◆ Smart DGPS WAAS Receiver with cable 15 mt/45 feet (**SW701e**)

## INSERTING/REMOVING PROCEDURE

### Inserting the MEDIA

Open the door. Hold the MEDIA by the short side. Gently push the MEDIA into the slot; press the MEDIA in as far as it will go to hold fixed into the slot.



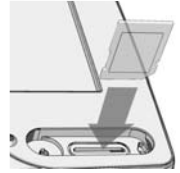
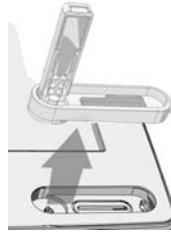
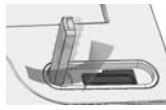

## Removing the MEDIA

Open the door, press in on the MEDIA and remove the MEDIA out of the slot.

## CHART PLOTTER DIMENSIONS

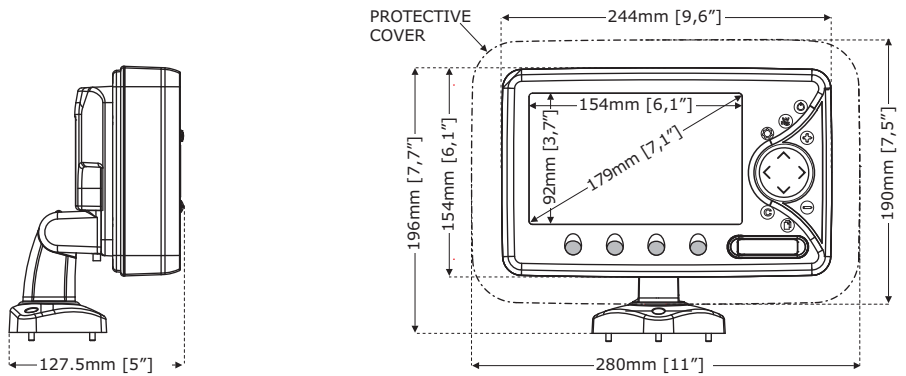

## INSTALLATION AND REMOVING

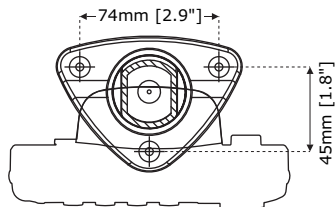

*Bracket Installation*

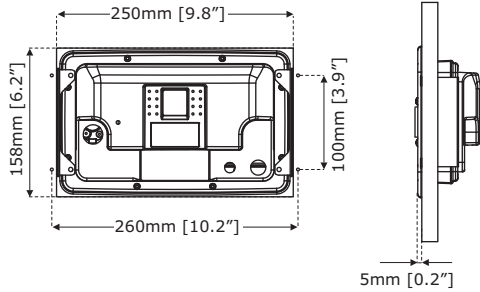
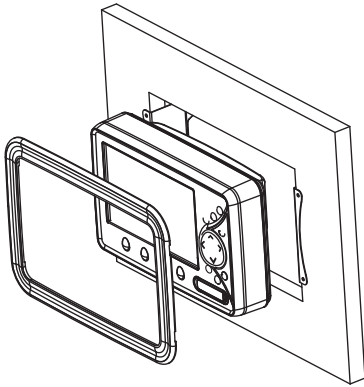

Flush Installation

## EXTERNAL WIRING

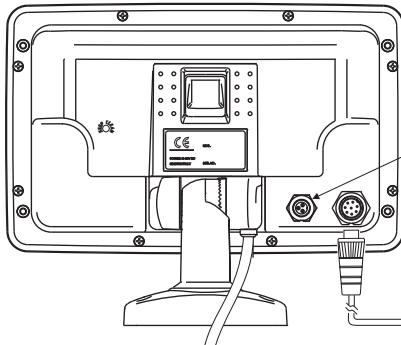

### VIDEO INPUT

CAM CONNECTORS  
PIN-OUT  
(ON UNIT)

1=GND COMMON  
2=POWER+ (10-35Vdc)  
3=SIGNAL

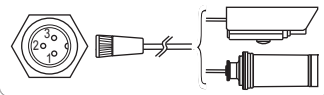

QUICK DISCONNECT BRACKET CABLE		
WIRE COLOR	DESCRIPTION	FUNCTION
BLACK	GND/COMMON	POWER SUPPLY GND
RED	POWER +10-35Vdc	POWER SUPPLY+
WHITE	INPUT1+	NMEA0183/C-COM
GREEN	SIGNAL RETURN-	SIGNAL RETURN
YELLOW	OUTPUT1+	NMEA0183/180/180CDX/C-COM
BROWN	INPUT2+	NMEA0183/C-COM
GRAY	OUTPUT2+	NMEA0183/180/180CDX/C-COM
ORANGE	INPUT3+ (*)	NMEA0183/C-COM
PINK	OUTPUT3+ (*)	NMEA0183/180/180CDX/C-COM
BLUE	SIGNAL RETURN-	SIGNAL RETURN

### AUX-IN I/O CABLE

PIN	WIRE COLOR	FUNCTION
1	BLACK	GND COMMON
2	RED	POWER OUTPUT+ (10-35 Vdc)
3	WHITE	INPUT 4+
4	GREEN	GND
5	GRAY	OUTPUT 5+
6	YELLOW	OUTPUT 4+
7	BROWN	INPUT 5+
8	BLUE	EXT. ALARM SIGNAL (to GND when ON)

(\*) Available on Chart Plotter with External GPS

External Wiring

# TYPICAL CONNECTIONS

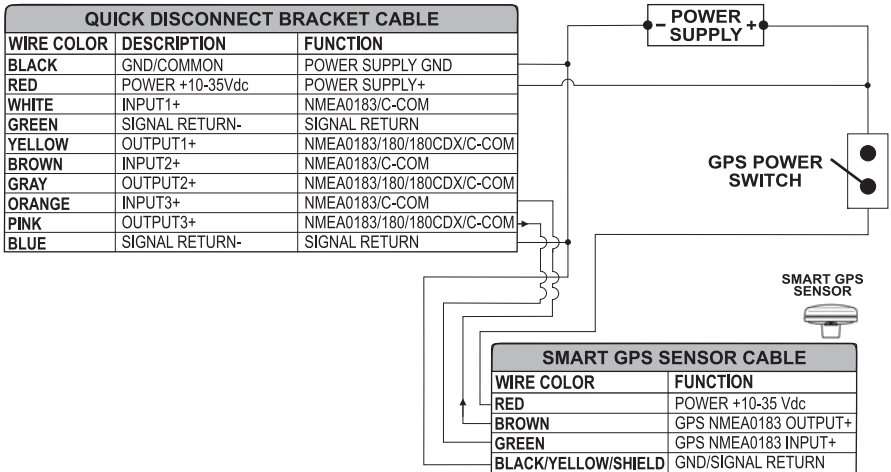

GPS Connection on Port 3 for *SW701e*

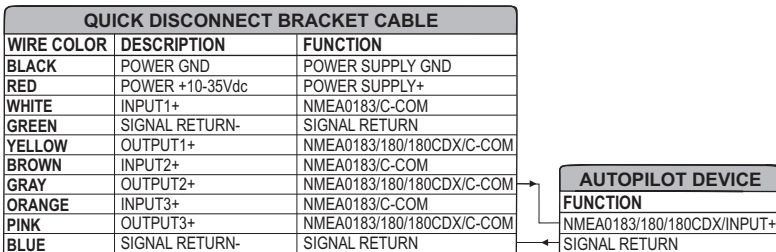

Autopilot Connection on Port 2

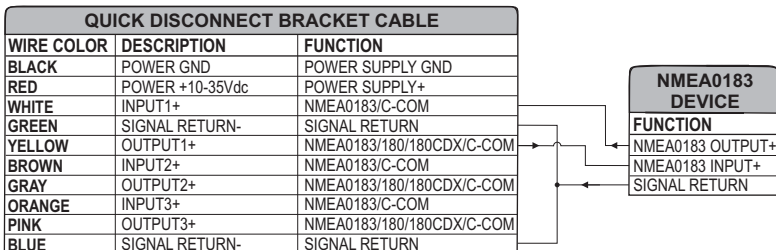

External NMEA Connection on Port 1

## C-COM Connection

To connect the modem C-COM to the chart plotter with quick disconnect bracket follow the procedure:

1. Cut the C-COM cable about 5 cm from the "T" connector:

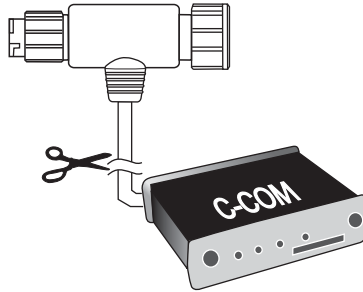

*C-COM cable cutting procedure*

2. Connect the wires to the quick disconnect bracket cable as follows:

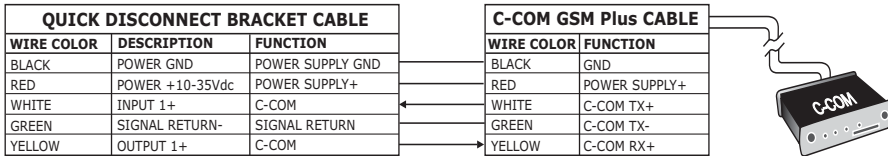

*C-COM Connection on Port 1*

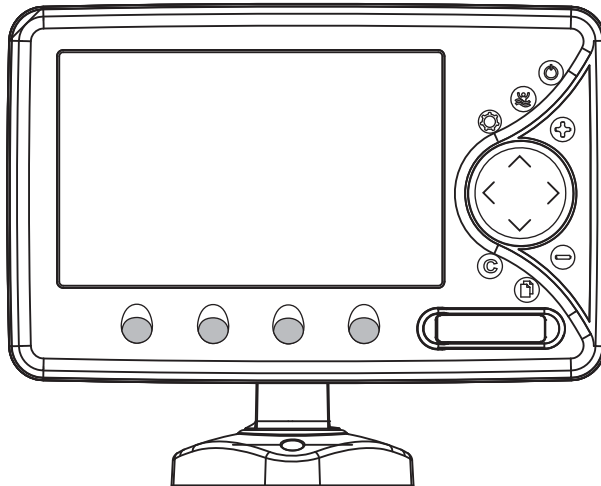

## FEATURES & FUNCTIONS

- ◆ Direct sunlight viewable color LCD 16/9 display WVGA (800x480) resolution
- ◆ Worldwide Built-in Cartography showing C-MAP By JEPPESEN detail up to 2.0 NM
- ◆ "C-MAP By JEPPESEN" MAX electronic charts, object-oriented chart system with enhanced functionality including:
  - Guardian alarm, Safety Status Bar, Safe Route Checking
  - Perspective View
  - Satellite Image Coverage
  - Turbo and Smooth Zoom
  - Multilanguage
  - Enhanced Port Information database
  - Tides & Currents data
  - Photos & Diagrams
  - Automatic Information on all chart objects and User Points
  - Find function for Ports Services, Ports By Name, Ports By Distance, Tide Stations, Wrecks, Obstructions, Lakes Information, Lakes By Name, Points Of Interest, Cursor, Coordinates and User Points
- ◆ Positional information from GPS
- ◆ Depth Graph pages
- ◆ Navigation Data page
- ◆ 3D Road page
- ◆ GPS Status page
- ◆ Wind Data page
- ◆ Gauges page
- ◆ DSC Log and DSC Directory pages
- ◆ AIS Report List page
- ◆ Fish Finder/Radar/Video Input pages<sup>1</sup>
- ◆ 10000 Waypoints/Marks and 50 Routes (10000 Waypoints max per Route)

- ♦ 10000 Track Points
- ♦ Create, Move, Insert, Edit, Delete, Send, Receive Waypoint
- ♦ Create, Move, Edit, Delete, Send, Receive Mark/Event
- ♦ Navigation to Goto
- ♦ Create, Save, Name, Edit, Delete, Send, Receive or Follow a Route
- ♦ Route Data Report and User Points (Marks/Waypoints) List pages
- ♦ Display vessel's position, direction and Track
- ♦ Alarms Handling (Auto Off, Arrival Alarm, XTE Alarm, Anchor Alarm, Depth Alarm, HDOP Alarm, Heading Alarm, Grounding Alarm, External Alarm)
- ♦ Man OverBoard (MOB) to navigate back to a missing person or object
- ♦ C-Link and C-Weather Service
- ♦ R-B function
- ♦ Simulation Mode with cursor control
- ♦ Video Input option
- ♦ Internal Fish Finder

**NOTE<sup>1</sup>** *If Radar/Video Camera connected.*

## TECHNICAL SPECIFICATIONS

- ♦ Operating Voltage : 10 - 35 Volt dc
- ♦ Power consumption : 12W average; 27W max peak
- ♦ Interface : NMEA-0183
- ♦ Autopilot Interface : NMEA-0180, NMEA-0180/CDX, NMEA-0183
- ♦ Video Input : PAL or NTSC video signals automatically selected
- ♦ Display : Color Sunlight Viewable LCD (*active area 7"*)
- ♦ Display Resolution : 800 x 480 pixels
- ♦ MEDIA : SD Card
- ♦ Cartography : C-MAP BY JEPPESEN DATA MEDIA
- ♦ Operating temperature range: 0/+55°C (32/+131°F)
- ♦ Memory : Non volatile
- ♦ Keyboard : Silicon rubber, backlight
- ♦ Weight : 1310 gr. (**SW701ci**)  
1260 gr. (**SW701ce**)

## FF MODULE 600W-50-200KHZ TECHNICAL SPECIFICATIONS

- ♦ Power Output : 600W (4800Wpp), 50/200KHz Dual Frequency
- ♦ Max Depth : 213m (700Ft) at 200kHz, 457m(1500Ft) at 50kHz
- ♦ Automatic Recognition of the AIRMAR "X-DUCER ID" transducers for best performance
- ♦ Advanced Digital Signal Processing
- ♦ Speed & Temperature Sensor (if available on transducer)
- ♦ Alarms (shallow water, depth, Fish, temp)
- ♦ Trip Log, Fish Symbols
- ♦ STC, Interference Rejection, Automatic noise reduction
- ♦ A-scope, White Line, Zoom x2/x4
- ♦ Auto range/gain/frequency/shift/ping rate

When the package containing the chart plotter is opened for the first time after

purchase, please make sure that the following contents are present (if any item is missing, please contact your local dealer):

- ◆ Quick Disconnect Bracket
- ◆ AUX IN I/O cable 1,5 mt/5.9 feet
- ◆ Video Input cable
- ◆ Chart plotter's protective cover
- ◆ Fuse 3.15 Amp. + fuseholder
- ◆ User Manual
- ◆ Flush mounting kit (OPTIONAL) + cutting template
- ◆ Smart DGPS WAAS Receiver with cable 15 mt/45 feet (SW701ce)

## INSERTING/REMOVING PROCEDURE

### Inserting the MEDIA

Open the door. Hold the MEDIA by the short side. Gently push the MEDIA into the slot; press the MEDIA in as far as it will go to hold fixed into the slot.

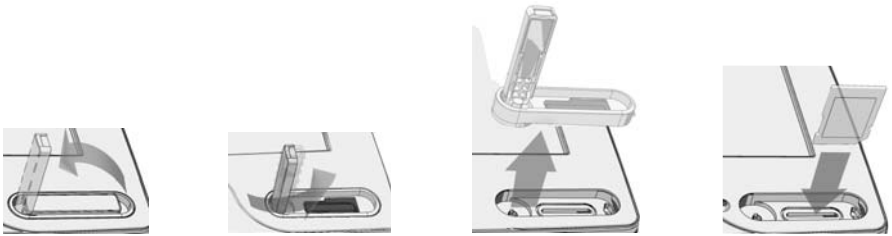

### Removing the MEDIA

Open the door, press in on the MEDIA and remove the MEDIA out of the slot.

## CHART PLOTTER DIMENSIONS

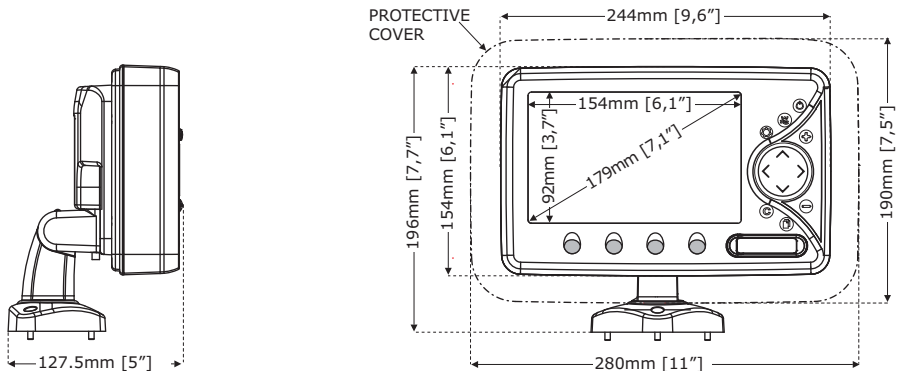

# INSTALLATION AND REMOVING

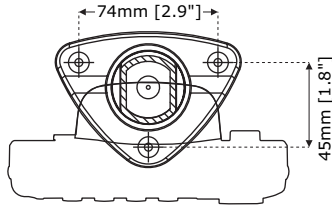

Bracket Installation

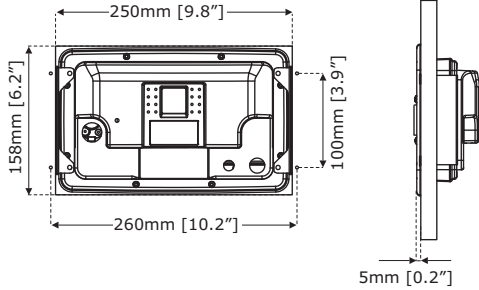
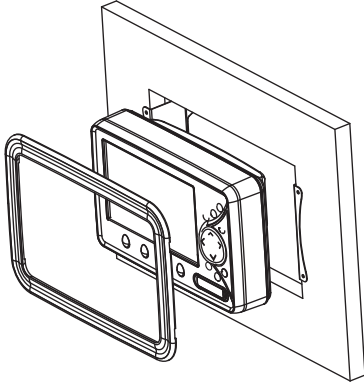

Flush Installation

## EXTERNAL WIRING

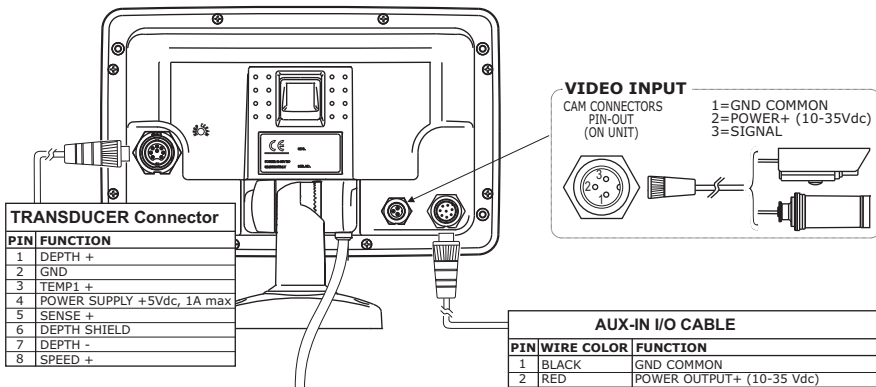

**QUICK DISCONNECT BRACKET CABLE**

WIRE COLOR	DESCRIPTION	FUNCTION
BLACK	GND/COMMON	POWER SUPPLY GND
RED	POWER +10-35Vdc	POWER SUPPLY+
WHITE	INPUT1+	NMEA0183/C-COM
GREEN	SIGNAL RETURN-	SIGNAL RETURN
YELLOW	OUTPUT1+	NMEA0183/180/180CDX/C-COM
BROWN	NC	
GRAY	NC	
ORANGE	INPUT3+ (*)	NMEA0183/C-COM
PINK	OUTPUT3+ (*)	NMEA0183/180/180CDX/C-COM
BLUE	SIGNAL RETURN-	SIGNAL RETURN

**AUX-IN I/O CABLE**

PIN	WIRE COLOR	FUNCTION
1	BLACK	GND COMMON
2	RED	POWER OUTPUT+ (10-35 Vdc)
3	WHITE	INPUT 4+
4	GREEN	GND
5	GRAY	OUTPUT 5+
6	YELLOW	OUTPUT 4+
7	BROWN	INPUT 5+
8	BLUE	EXT. ALARM SIGNAL (to GND when ON)

(\*) Available on Chart Plotter with External GPS

External Connection



# TYPICAL CONNECTIONS

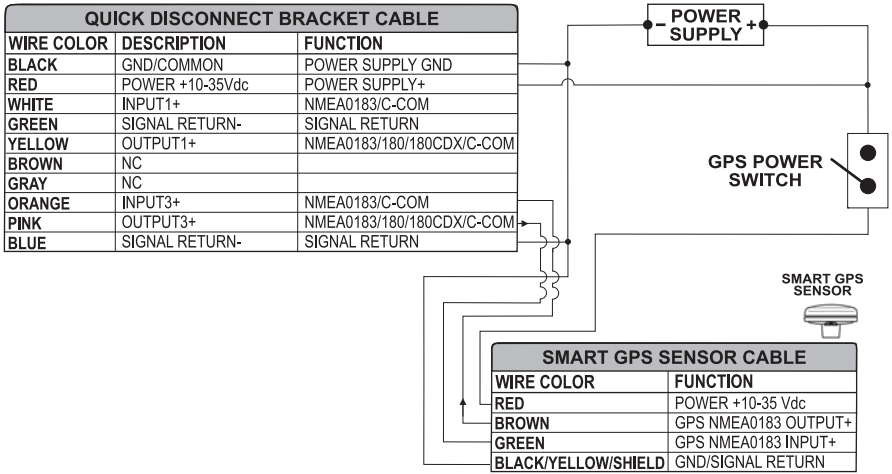

GPS Connection on Port 3 for *SW701ce*

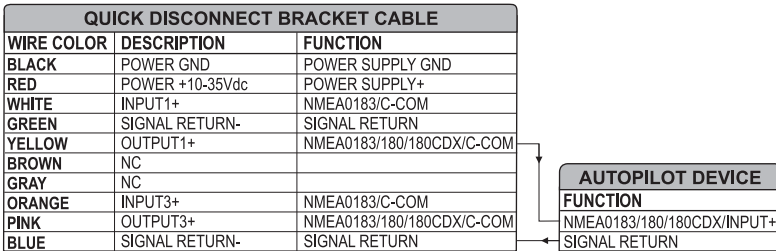

Autopilot Connection on Port 1

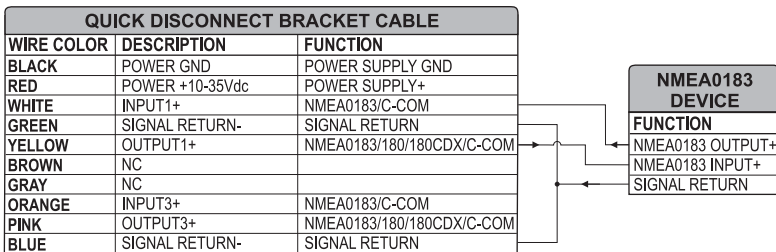

External NMEA Connection on Port 1

## C-COM Connection

To connect the modem C-COM to the chart plotter with quick disconnect bracket follow the procedure:

1. Cut the C-COM cable about 5 cm from the "T" connector:

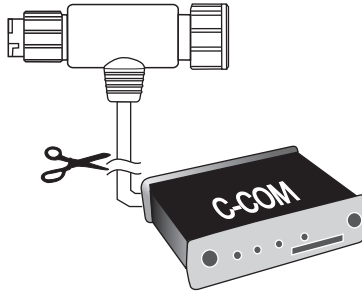

*C-COM cable cutting procedure*

2. Connect the wires to the quick disconnect bracket cable as follows:

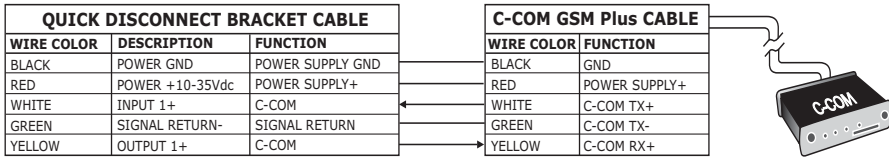

*C-COM Connection on Port 1*

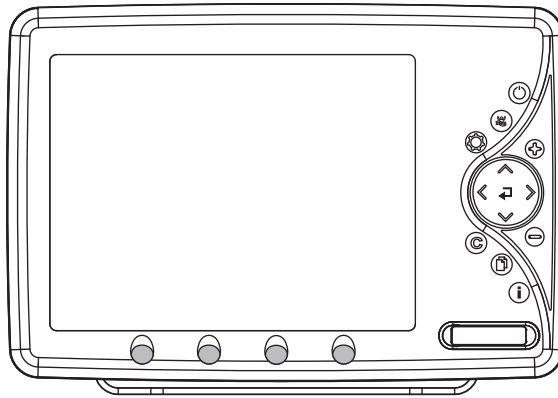

## FEATURES & FUNCTIONS

- ◆ Direct sunlight viewable color 11" LCD display
- ◆ Worldwide Built-in Cartography showing C-MAP By JEPPESEN detail up to 2.0 NM
- ◆ "C-MAP By JEPPESEN" MAX electronic charts, object-oriented chart system with enhanced functionality including:
  - Guardian alarm, Safety Status Bar, Safe Route Checking
  - Perspective View
  - Satellite Image Coverage
  - Turbo and Smooth Zoom
  - Multilanguage
  - Enhanced Port Information database
  - Tides & Currents data
  - Photos & Diagrams
  - Automatic Information on all chart objects and User Points
  - Find function for Ports Services, Ports By Name, Ports By Distance, Tide Stations, Wrecks, Obstructions, Lakes Information, Lakes By Name, Points Of Interest, Cursor, Coordinates and User Points
- ◆ Positional information from GPS
- ◆ Depth Graph pages
- ◆ Navigation Data page
- ◆ 3D Road page
- ◆ GPS Status page
- ◆ Wind Data page
- ◆ Gauges page
- ◆ DSC Log and DSC Directory pages
- ◆ AIS Report List page
- ◆ Fish Finder/Radar/Video Input pages<sup>1</sup>
- ◆ 10000 Waypoints/Marks and 50 Routes (10000 Waypoints max per Route)

- ◆ 10000 Track Points
- ◆ Create, Move, Insert, Edit, Delete, Send, Receive Waypoint
- ◆ Create, Move, Edit, Delete, Send, Receive Mark/Event
- ◆ Navigation to Goto
- ◆ Create, Save, Name, Edit, Delete, Send, Receive or Follow a Route
- ◆ Route Data Report and User Points (Marks/Waypoints) List pages
- ◆ Display vessel's position, direction and Track
- ◆ Alarms Handling (Auto Off, Arrival Alarm, XTE Alarm, Anchor Alarm, Depth Alarm, HDOP Alarm, Heading Alarm, Grounding Alarm, External Alarm)
- ◆ Man OverBoard (MOB) to navigate back to a missing person or object
- ◆ C-Link and C-Weather Service
- ◆ R-B function
- ◆ Simulation Mode with cursor control
- ◆ Video Input option
- ◆ Video Output option

**NOTE<sup>1</sup>** *If Fish Finder/Radar/Video Camera connected.*

## TECHNICAL SPECIFICATIONS

- ◆ Power consumption : 1.3A max @ 12V
- ◆ Power consumption : 1.5A max @ 12V (with camera connected)
- ◆ Interface : NMEA0183
- ◆ Autopilot Interface : NMEA-0180, NMEA-0180/CDX, NMEA-0183
- ◆ Video Input : PAL or NTSC video signals automatically selected
- ◆ Video Output : VGA compatible
- ◆ Display : TFT transmissive LCD (*active area 10.4"*)
- ◆ Display Resolution : 800 x 600 pixels
- ◆ MEDIA : SD Card
- ◆ Cartography : C-MAP BY JEPPESEN DATA MEDIA
- ◆ Operating temperature range : 32/131 °F (0/+55 °C)
- ◆ Memory : Non volatile
- ◆ Keyboard : Silicon rubber, backlight
- ◆ Weight : 1,6 Kg

When the package containing the chart plotter is opened for the first time after purchase, please make sure that the following contents are present (if any item is missing, please contact your local dealer):

- ◆ External bracket and I/O cable 1,5 mt/5.9 feet
- ◆ AUX IN I/O cable 1,5 mt/5.9 feet
- ◆ Video Input cable (2 pcs)
- ◆ Video Output cable
- ◆ Chart plotter's protective cover
- ◆ Fuse 2 Amp. + fuseholder
- ◆ User Manual
- ◆ Flush mounting kit + cutting template
- ◆ Smart DGPS WAAS Receiver with cable 15 mt/45 feet

# INSERTING/REMOVING PROCEDURE

## Inserting the MEDIA

Open the door. Hold the MEDIA by the short side. Gently push the MEDIA into the slot; press the MEDIA in as far as it will go to hold fixed into the slot.

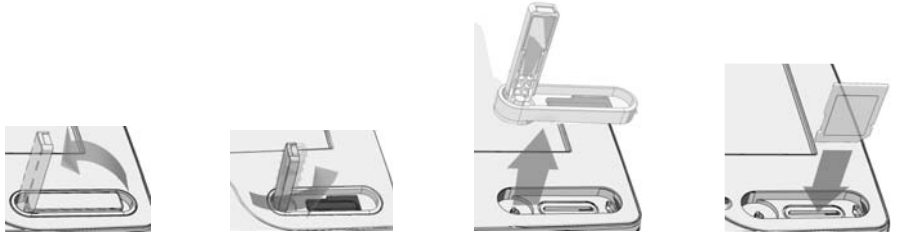

## Removing the MEDIA

Open the door, press in on the MEDIA and remove the MEDIA out of the slot.

## CHART PLOTTER DIMENSIONS

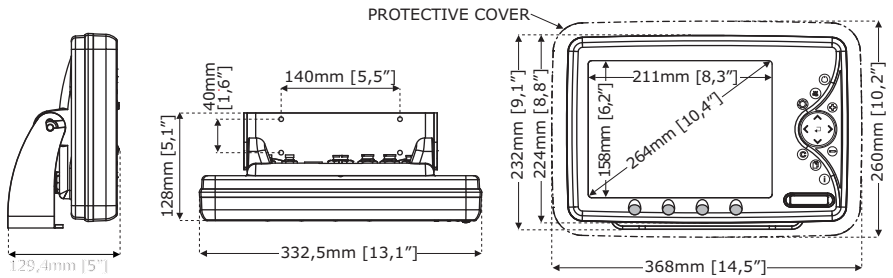

## INSTALLATION AND REMOVING

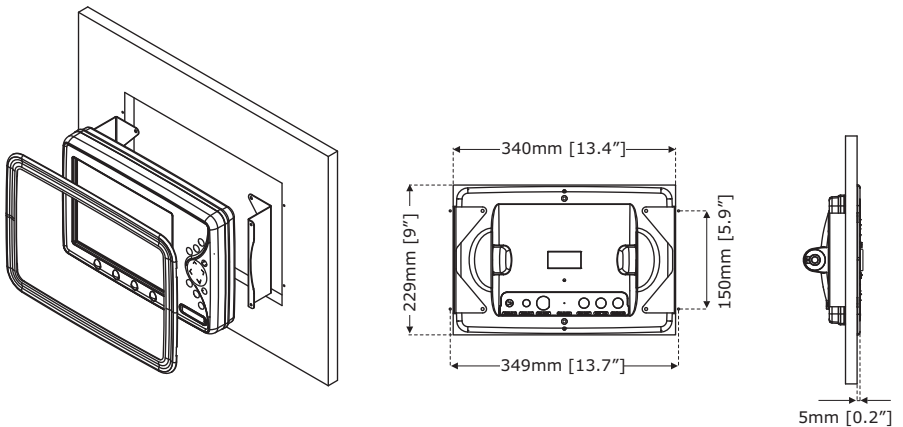

# EXTERNAL WIRING

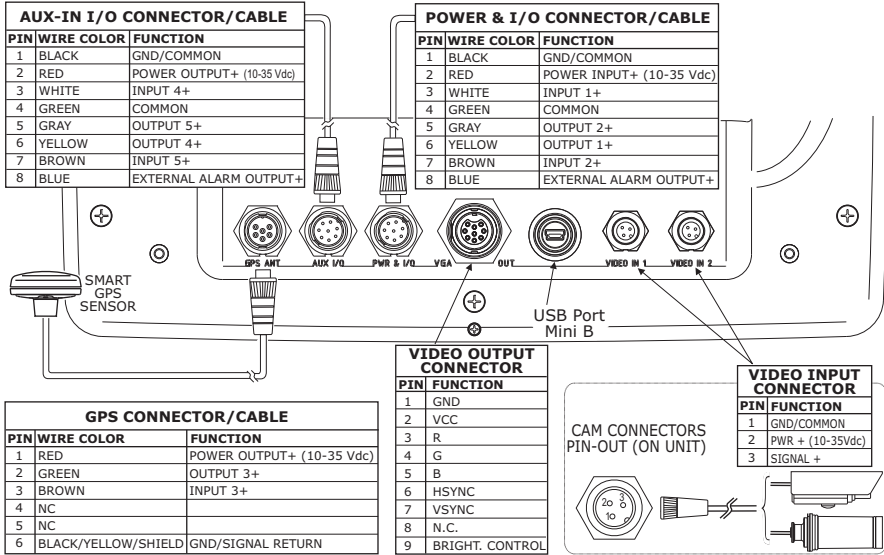

## TYPICAL CONNECTIONS

### GPS Connection

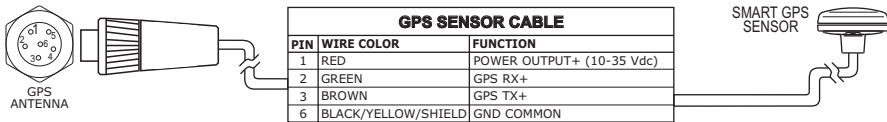

GPS on Port 3

### Autopilot Connection

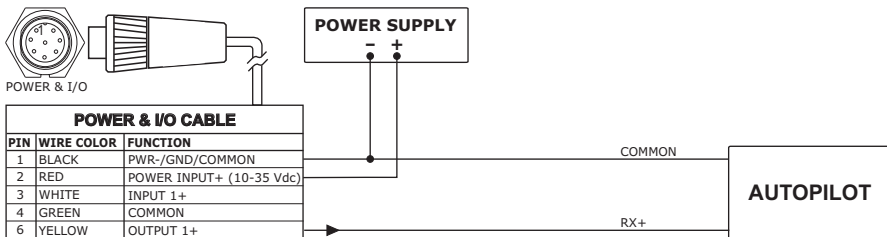

Autopilot on Port 1

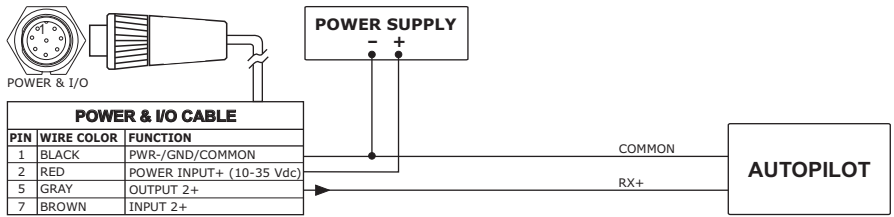

## External NMEA Connection

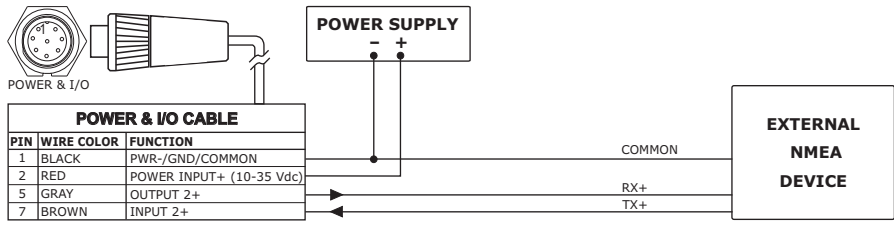
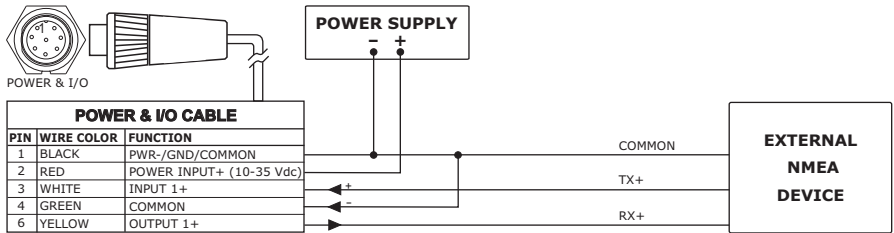

## External Alarm Connection

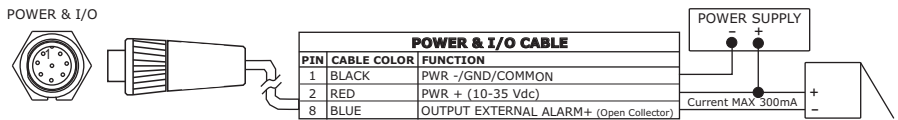

# C-COM GSM PLUS Connection

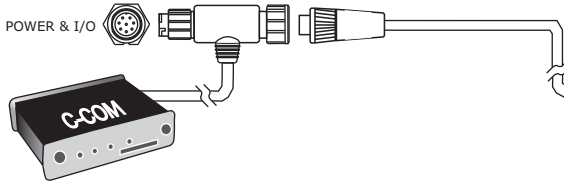

POWER & I/O CONNECTOR		
PIN	CABLE COLOR	FUNCTION
1	BLACK	PWR-/GND/COMMON
2	RED	PWR+ (10-35 Vdc)
3	WHITE	Used by C-COM
4	GREEN	Used by C-COM
5	GRAY	OUTPUT2+
6	YELLOW	Used by C-COM
7	BROWN	INPUT2+
8	BLUE	OUTPUT EXTERNAL ALARM+

C-COM Connection



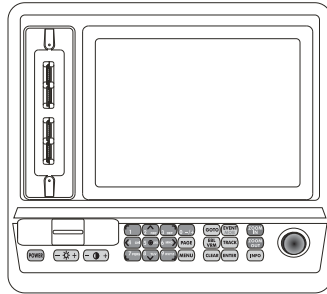

## FEATURES & FUNCTIONS

- ◆ Direct sunlight viewable color LCD 12.1" TFT Color, polarized display
- ◆ Worldwide Built-in Cartography showing C-MAP By JEPPESEN detail up to 2.0 NM
- ◆ "C-MAP By JEPPESEN" MAX electronic charts, object-oriented chart system with enhanced functionality including:
  - Guardian alarm, Safety Status Bar, Safe Route Checking
  - Perspective View
  - Satellite Image Coverage
  - Turbo and Smooth Zoom
  - Multilanguage
  - Enhanced Port Information database
  - Tides & Currents data
  - Photos & Diagrams
  - Automatic Information on all chart objects and User Points
  - Find function for Ports Services, Ports By Name, Ports By Distance, Tide Stations, Wrecks, Obstructions, Lakes Information, Lakes By Name, Points Of Interest, Cursor, Coordinates and User Points
- ◆ Positional information from GPS
- ◆ Depth Graph pages
- ◆ Navigation Data page
- ◆ 3D Road page
- ◆ GPS Status page
- ◆ Gauges page
- ◆ DSC Log and DSC Directory pages
- ◆ AIS Report List page
- ◆ Fish Finder/Radar/Video Input pages<sup>1</sup>
- ◆ 10000 Waypoints/Events/Marks
- ◆ Dynamic handling of User Points & Routes (the number of Routes and Waypoints per Route is dynamic, for example 10000 Routes with 1 Waypoint each or 1 Route with 10000 Waypoints).
- ◆ 10000 Track Points
- ◆ Create, Move, Insert, Edit, Delete, Send, Receive Waypoint
- ◆ Create, Move, Edit, Delete, Send, Receive Mark/Event
- ◆ Navigation to Goto
- ◆ Create, Save, Name, Edit, Delete, Send, Receive or Follow a Route

- ◆ Route Data Report and User Points (Marks/Events/Waypoints) List pages
- ◆ Display vessel's position, direction and Track
- ◆ Alarms Handling (Auto Off, Arrival Alarm, XTE Alarm, Anchor Alarm, Depth Alarm, HDOP Alarm, Heading Alarm, Timer Alarm, Grounding Alarm, External Alarm)
- ◆ Man OverBoard (MOB) to navigate back to a missing person or object
- ◆ C-Link and C-Weather Service
- ◆ EBL-VRM and A-B functions
- ◆ Simulation Mode with cursor control
- ◆ Video Input option
- ◆ Video Output option

**NOTE<sup>1</sup>** *If Fish Finder/Radar/Video Camera connected.*

## TECHNICAL SPECIFICATIONS

- ◆ Power consumption : 1.6A @10V
- ◆ Power supply : 10 - 35 Volt dc, 16 Watt
- ◆ Interface : NMEA0183
- ◆ Autopilot Interface : NMEA-0180, NMEA-0180/CDX, NMEA-0183
- ◆ Video Input : PAL or NTSC video signals automatically selected
- ◆ Video Output : VGA compatible (with adapter cable)
- ◆ Display : LCD 12.1" TFT Color, polarized
- ◆ Display Resolution : 800 x 600 pixels
- ◆ MEDIA : C-Card
- ◆ Cartography : C-MAP By JEPPESEN DATA MEDIA
- ◆ Auxiliary Memory : SD-Card 16 MB or more
- ◆ Operating temperature range : 32/131 °F (0/+55 °C)
- ◆ Memory : Non volatile with battery back-up
- ◆ Keyboard : Silicon rubber, backlight
- ◆ Weight : 6,2 Kg

When the package containing the chart plotter is opened for the first time after purchase, please make sure that the following contents are present (if any item is missing, please contact your local dealer):

- ◆ Power supply and I/O 8 pins cable 1,5 mt./5.9 feet; cable code CBCOFS0804
- ◆ Desktop brackets kit
- ◆ Two I/O 6 pins cables 1 mt./3.9"; cable code CBCOFS0603
- ◆ Fuse 2 Amp. + fuseholder (2pcs)
- ◆ External packaging
- ◆ User Manual

## INSERTING/REMOVING PROCEDURE

### Inserting the MEDIA

Hold the MEDIA by the short inclined side so that you can see the C-MAP By JEPPESEN label. Gently push the MEDIA into one of the two slots (1); push the MEDIA in as far as it will go, then move it to the right (2) to hold fixed into the slot (3).

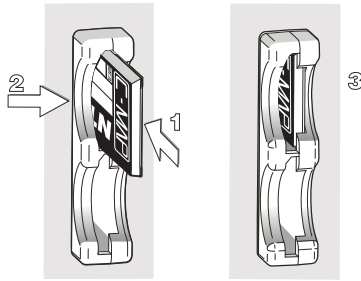

The new cartography information will be displayed when you move the cursor into an area covered by the new charts making pan or zoom operations. The boundary of each chart digitized in the current MEDIA is shown as a rectangle.

### Removing the MEDIA

Press lightly the MEDIA you wish to remove (1) and move it to the left (2) until you hear a click: the MEDIA will ejected out of the slot (3).

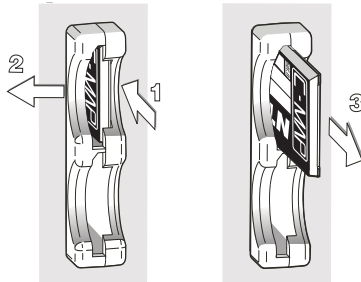

## CHART PLOTTER DIMENSIONS

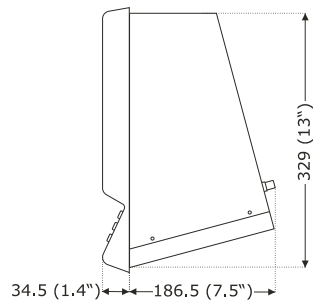
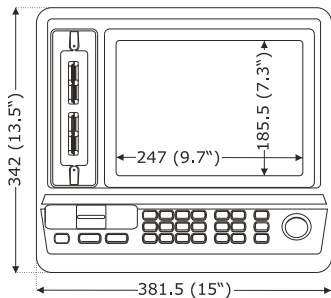

# INSTALLATION AND REMOVING

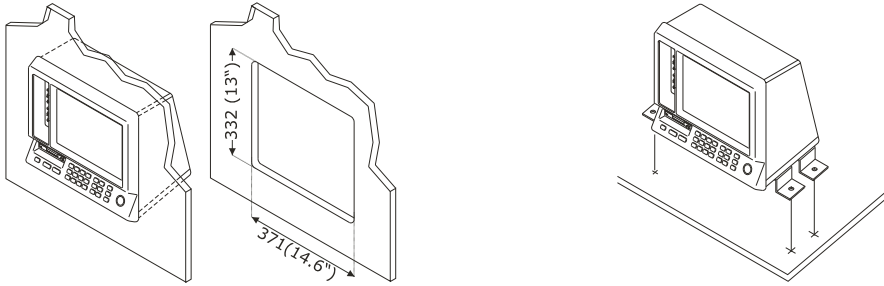

## EXTERNAL CONNECTIONS

### Power & I/O and Autopilot Connection

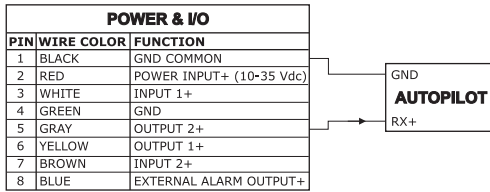

### External Alarm Connection

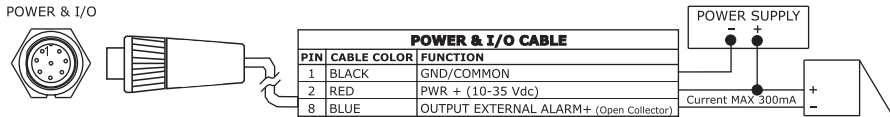

### GPS Connection

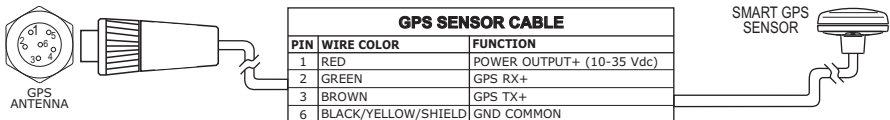

## AUX IN I/O and External NMEA Connection

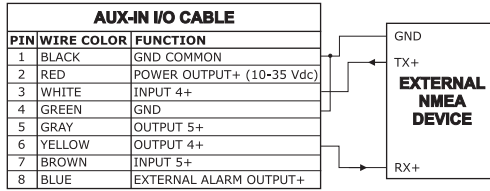

## Video Input Connector

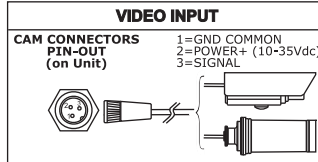

## Video Output Connector

VIDEO OUTPUT	
PIN	FUNCTION
1	GND
2	VCC
3	R
4	G
5	B
6	HSYNC
7	VSYNC
8	N.C.
9	BRIGHTNESS CONTROL

## C-COM Connector

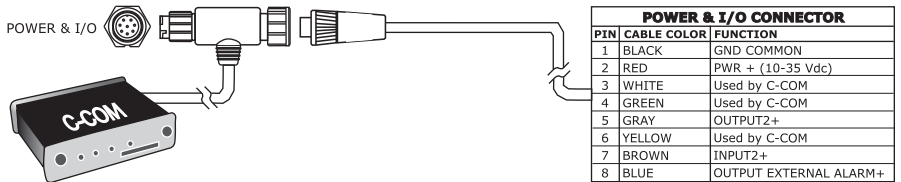



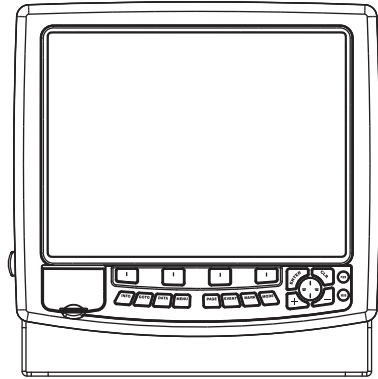

## FEATURES & FUNCTIONS

- ◆ Color 15" LCD Display
- ◆ Worldwide Built-in Cartography showing C-MAP detail up to 2.0 NM
- ◆ "C-MAP BY JEPPESEN" MAX electronic charts, object-oriented chart system with enhanced functionality including:
  - Guardian alarm, Safety Status Bar, Safe Route Checking
  - Perspective View
  - Satellite Image Coverage
  - Turbo and Smooth Zoom
  - Multilanguage
  - Enhanced Port Information database
  - Tides & Currents data
  - Photos & Diagrams
  - Automatic Information on all chart objects and User Points
  - Find function for Ports Services, Ports By Name, Ports By Distance, Tide Stations, Wrecks, Obstructions, Lakes Information, Lakes By Name, Points Of Interest, Cursor, Coordinates and User Points
- ◆ Positional information from GPS
- ◆ Depth Graph pages
- ◆ Navigation Data page
- ◆ 3D Road page
- ◆ GPS Status page
- ◆ Wind Data page
- ◆ Gauges page
- ◆ DSC Log and DSC Directory pages
- ◆ AIS Report List page
- ◆ Fish Finder/Radar/Video Input pages<sup>1</sup>
- ◆ 10000 Waypoints/Events/Marks
- ◆ Dynamic handling of User Points & Routes (the number of Routes and Waypoints per Route is dynamic, for example 10000 Routes with 1 Waypoint each or 1 Route with 10000 Waypoints).
- ◆ 10000 Track Points
- ◆ Create, Move, Insert, Edit, Delete, Send, Receive Waypoint

- Create, Move, Edit, Delete, Send, Receive Mark/Event
- Navigation to Goto
- Create, Save, Name, Edit, Delete, Send, Receive or Follow a Route
- Route Data Report and User Points (Marks/Events/Waypoints) List pages
- Display vessel's position, direction and Track
- Alarms Handling (Auto Off, Arrival Alarm, XTE Alarm, Anchor Alarm, Depth Alarm, HDOP Alarm, Heading Alarm, Timer Alarm, Grounding Alarm, External Alarm)
- Man OverBoard (MOB) to navigate back to a missing person or object
- C-Link and C-Weather Service
- EBL-VRM and A-B functions
- Simulation Mode with cursor control
- Video Input option
- Video Output option

**NOTE<sup>1</sup>** *If Fish Finder/Radar/Video Camera connected.*

## TECHNICAL SPECIFICATIONS

- Power consumption : 3 A max, @ 12 V
- Interface : NMEA0183
- Autopilot Interface : NMEA-0180, NMEA-0180/CDX, NMEA-0183
- Video Input : PAL or NTSC video signals automatically selected
- Video Output : VGA compatible
- Display : TFT transmissive LCD (*active area 15"*)
- Display Resolution : 1024 x 768 pixels
- MEDIA : C-Card
- Cartography : C-MAP BY JEPPESEN DATA MEDIA
- Operating temperature range : 32/131 °F (0/+55 °C)
- Memory : Internal non volatile for user data backup
- Keyboard : Silicon rubber, backlight
- Weight : 4,5 Kg

When the package containing the chart plotter is opened for the first time after purchase, please make sure that the following contents are present (if any item is missing, please contact your local dealer):

- External bracket and I/O cable 1,5 mt/5.9 feet
- AUX IN I/O cable 1,5 mt/5.9 feet (2 pcs)
- Video Input cable (2 pcs)
- Video Output cable
- Chart plotter's protective cover
- Fuse 5 Amp. + fuseholder
- User Manual
- Flush mounting kit + cutting template
- Smart DGPS WAAS Receiver with cable 15 mt/45 feet

## INSERTING/REMOVING PROCEDURE

### Inserting the MEDIA

Hold the MEDIA by the short inclined side so that you can see the C-MAP BY JEPPESEN label. Open the door, gently push the MEDIA into one of the two slots; push the MEDIA in as far as it will go, then close the door to hold fixed into the slot.



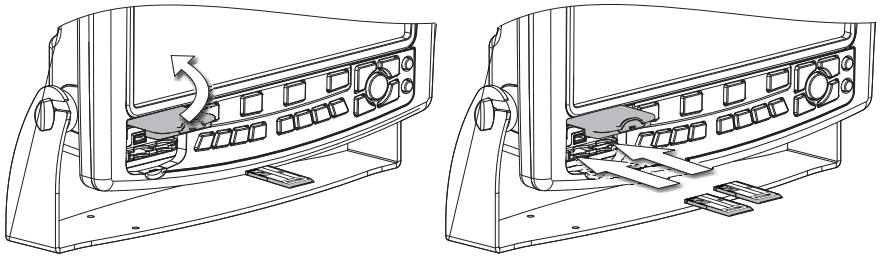

## Removing the MEDIA

Open the door and remove the MEDIA out of the slot.

## CHART PLOTTER DIMENSIONS

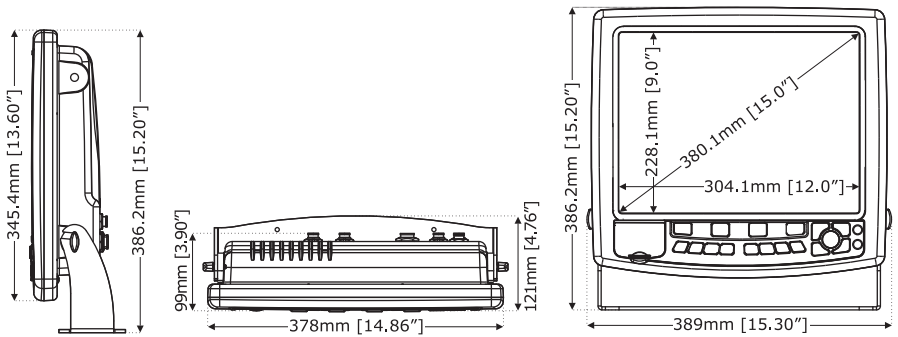

## INSTALLATION AND REMOVING

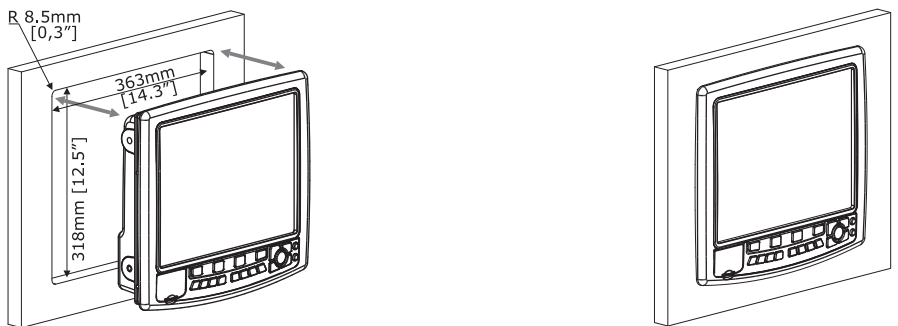

# EXTERNAL WIRING

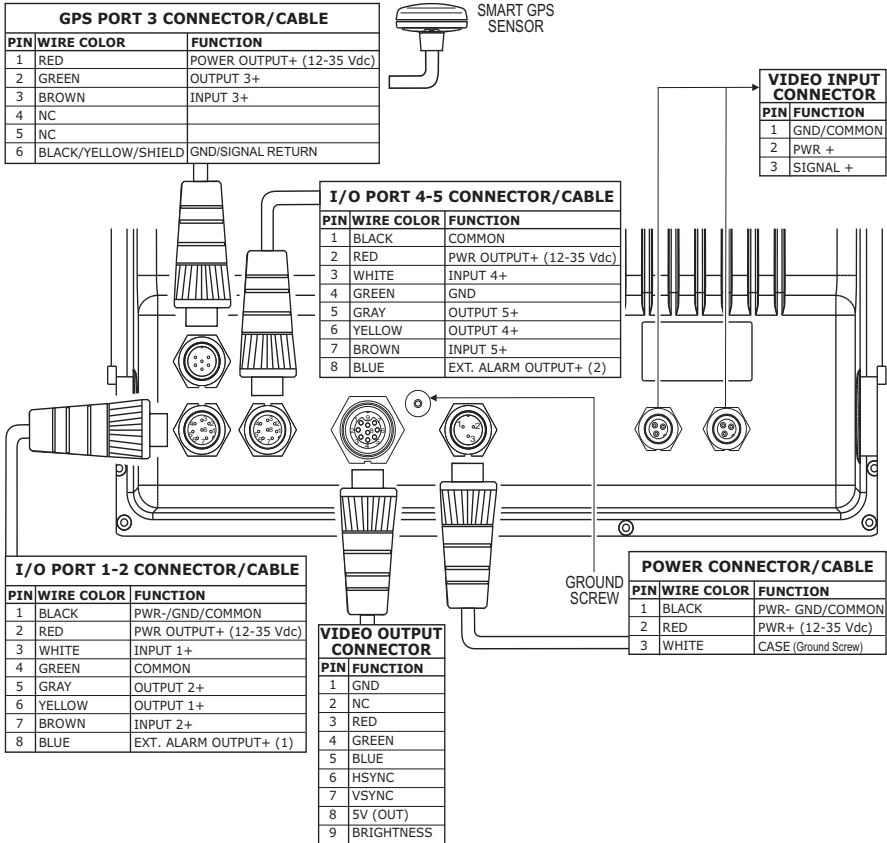

## TYPICAL CONNECTIONS

### GPS Connection

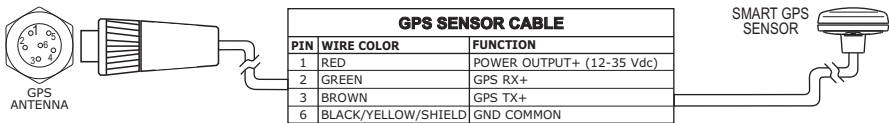

GPS on Port 3

## Autopilot Connection

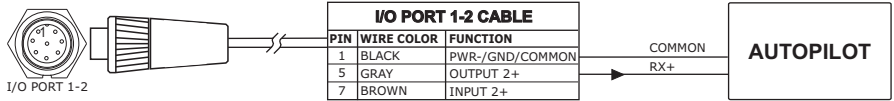

Autopilot on Port 2

## External NMEA Connection

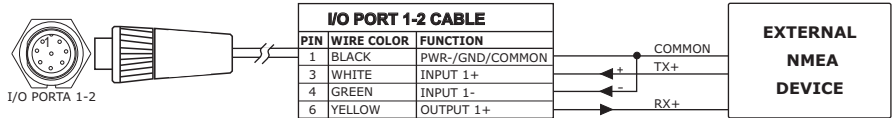

External NMEA on Port 1

## External Alarm Connection

I/O PORT 1-2		
PIN	WIRE COLOR	FUNCTION
1	BLACK	GND/Common
8	BLUE	EXTERNAL ALARM OUTPUT+ (OPEN COLLECTOR)

External Alarm Connection

## C-COM GSM PLUS Connection

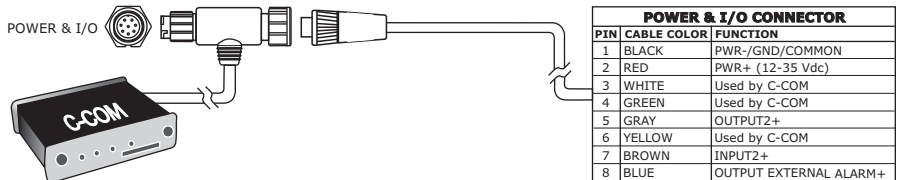

C-COM Connection



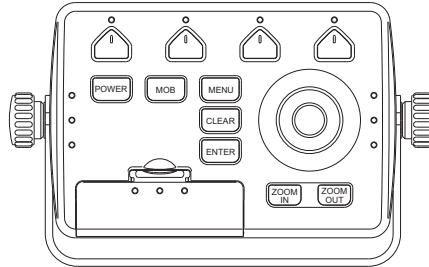

## FEATURES & FUNCTIONS

- ◆ Worldwide Built-in Cartography showing C-MAP detail up to 2.0 NM
- ◆ "C-MAP By JEPPESEN" MAX electronic charts, object-oriented chart system with enhanced functionality including:
  - Guardian alarm, Safety Status Bar, Safe Route Checking
  - Perspective View
  - Satellite Image Coverage
  - Turbo and Smooth Zoom
  - Multilanguage
  - Enhanced Port Information database
  - Tides & Currents data
  - Photos & Diagrams
  - Automatic Information on all chart objects and User Points
  - Find function for Ports Services, Ports By Name, Ports By Distance, Tide Stations, Wrecks, Obstructions, Lakes Information, Lakes By Name, Points Of Interest, Cursor, Coordinates and User Points
- ◆ Positional information from GPS
- ◆ Depth Graph pages
- ◆ Navigation Data page
- ◆ 3D Road page
- ◆ GPS Status page
- ◆ Wind Data page
- ◆ Gauges page
- ◆ DSC Log and DSC Directory pages
- ◆ AIS Report List page
- ◆ Fish Finder/Radar pages<sup>1</sup>
- ◆ 10000 Waypoints/Marks
- ◆ Dynamic handling of User Points & Routes (the number of Routes and Waypoints per Route is dynamic, for example 10000 Routes with 1 Waypoint each or 1 Route with 10000 Waypoints).
- ◆ 10000 Track Points
- ◆ Create, Move, Insert, Edit, Delete, Send, Receive Waypoint
- ◆ Create, Move, Edit, Delete, Send, Receive Mark/Event
- ◆ Navigation to Goto
- ◆ Create, Save, Name, Edit, Delete, Send, Receive or Follow a Route
- ◆ Route Data Report and User Points (Marks/Waypoints) List pages
- ◆ Display vessel's position, direction and Track

- Alarms Handling (Auto Off, Arrival Alarm, XTE Alarm, Anchor Alarm, Depth Alarm, HDOP Alarm, Heading Alarm, Grounding Alarm, External Alarm)
- Man OverBoard (MOB) to navigate back to a missing person or object
- C-Link and C-Weather Service
- R-B function
- Simulation Mode with cursor control
- Video Output option

**NOTE<sup>1</sup>** *If Fish Finder/Radar connected.*

## TECHNICAL SPECIFICATIONS

- Power consumption : 0.25 A max, @ 12 V
- Interface : NMEA0183
- Autopilot Interface : NMEA-0180, NMEA-0180/CDX, NMEA-0183
- Video Output : VGA compatible
- Display Resolution : 640x480 or 800x600 or 1024x768 pixels user selectable
- MEDIA : C-Card
- Cartography : C-MAP By JEPPESEN DATA MEDIA
- Operating temperature range : 32/131 °F (0/+55 °C)
- Memory : Non volatile with battery backup
- Keyboard : Silicon rubber, backlight
- Weight : 950 gr.

When the package containing the controller is opened for the first time after purchase, please make sure that the following contents are present (if any item is missing, please contact your local dealer):

- External bracket
- Power supply and I/O (CBCOFS0804) I/O, cable CBCOFS0603
- AUX IN I/O cable 1,5 mt/5.9 feet (2 pcs)
- Video Output cable
- Fuse 1A (2 pcs) + cable fuse holder (2 pcs)
- User Manual

## INSERTING/REMOVING PROCEDURE

### Inserting the MEDIA

Hold the MEDIA by the short inclined side so that you can see the C-MAP By JEPPESEN label. Open the MEDIA slot's door pressing (1) to the bottom (2). Gently push the MEDIA into one of the two slots; push the MEDIA in as far as it will go (3), then move it to the bottom (4) to hold fixed into the slot.

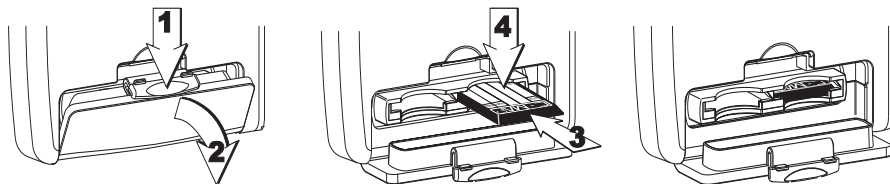

## Removing the MEDIA

Open the MEDIA slot's door pressing (1) to the bottom (2). Press lightly (3) the MEDIA you wish to remove and move it to the top (4) until you hear a click: the MEDIA will eject out of the slot (5).

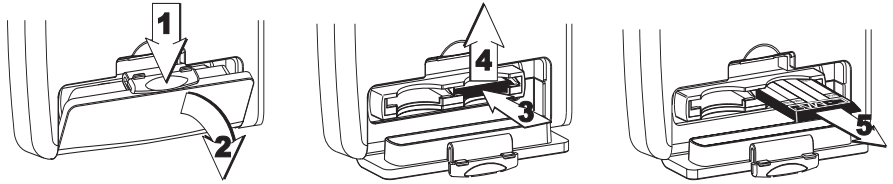

## CONTROLLER DIMENSIONS

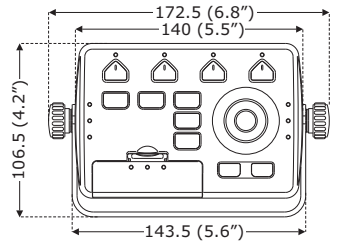
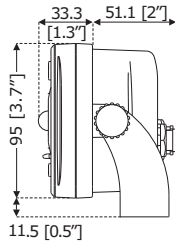

## INSTALLATION AND REMOVING

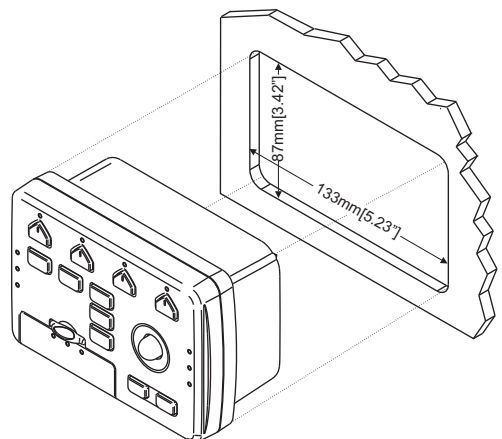
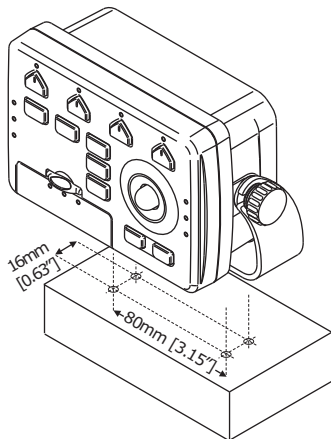

### WARNING

*In order to protect the chart plotter video board, please make sure that the power cables of the monitor and of the chart plotter are physically separated, with protection against electrical discharge.*

# EXTERNAL WIRING

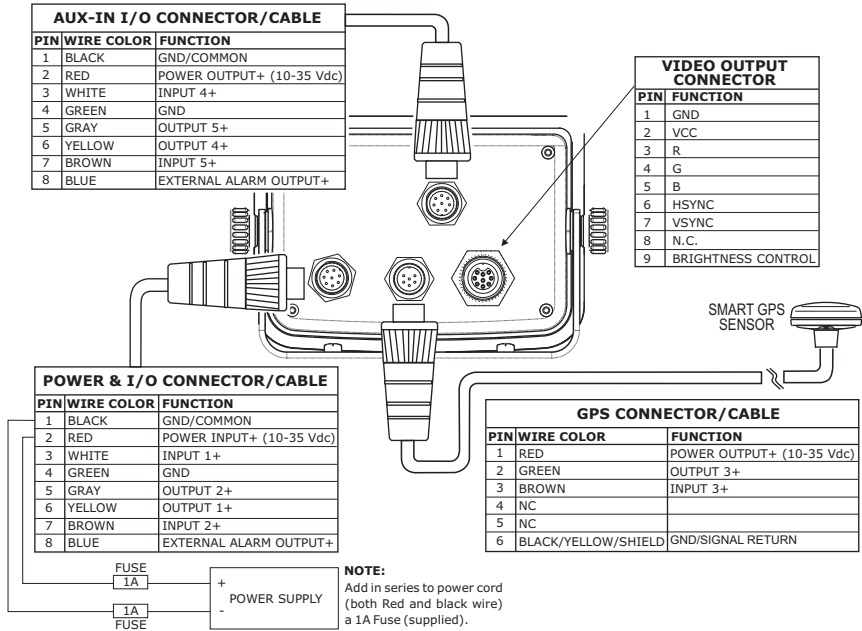

## TYPICAL CONNECTIONS

### GPS Connection

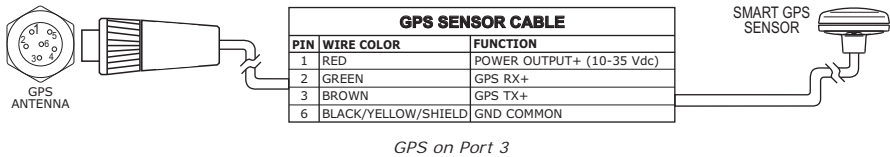

### Autopilot Connection

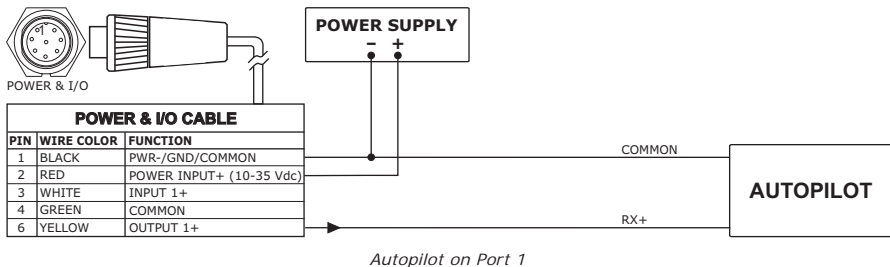



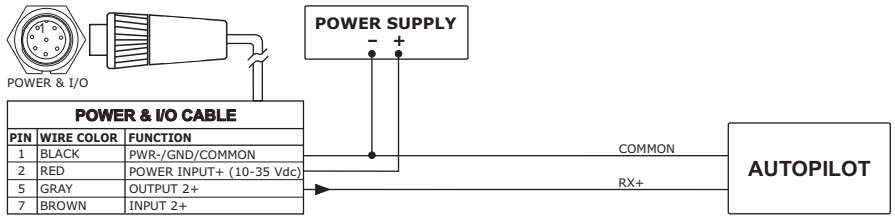

Autopilot on Port 2

## External NMEA Connection

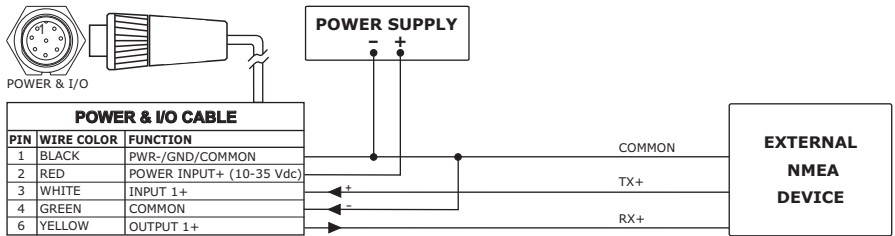

External NMEA on Port 1

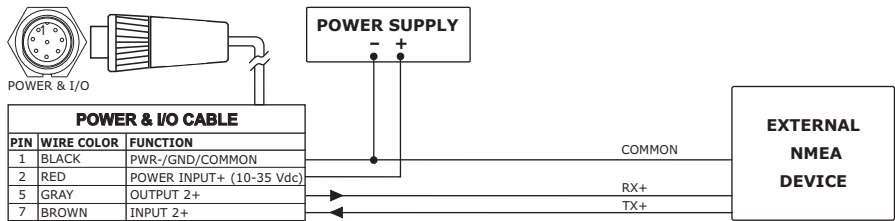

External NMEA on Port 2

## Power Alarm Connection

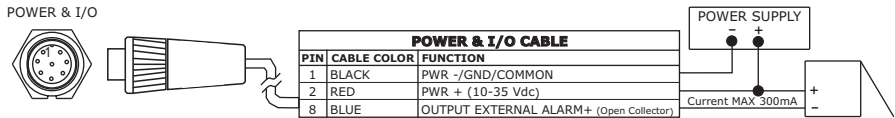

External Alarm Connection

# C-COM GSM PLUS Connection

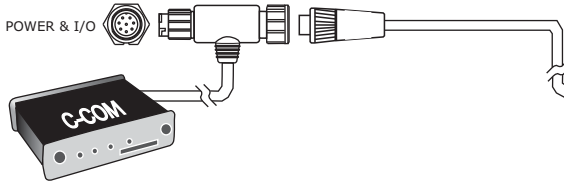

POWER & I/O CONNECTOR		
PIN	CABLE COLOR	FUNCTION
1	BLACK	PWR-/GND/COMMON
2	RED	PWR+ (10-35 Vdc)
3	WHITE	Used by C-COM
4	GREEN	Used by C-COM
5	GRAY	OUTPUT2+
6	YELLOW	Used by C-COM
7	BROWN	INPUT2+
8	BLUE	OUTPUT EXTERNAL ALARM+

C-COM Connection

# Installing the Smart GPS External

SW501e/SW501ce/SW701e/SW701ce/SW1101/SEAWAVE<sup>3</sup>/  
MARLIN/EXPLORER<sup>3</sup>

---

## INSTALLING

Choose a location for the antenna that has a clear view of the sky. Ensure there are no major obstructions or fixtures in the immediate proximity to the antenna. The antenna relies on direct “line of sight” satellite reception. If you are unsure that the chosen location is suitable it may be advisable to mount the antenna in a temporary manner to verify correct operation. The thread used on the antenna (1", 14 TPI) is an industry standard thread used on a wide range of mounting brackets, including the swivel joints commonly used for angled surfaces. However due to the manufacturing process of these mounting brackets you may see that there is some slop when tightening down the antenna to the bracket. This is of no concern however as the antenna must be tightened until the antenna stops rotating on the antenna mounting bracket.

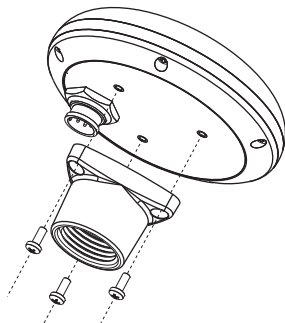

*Installing GPS Antenna (I)*

The antenna design also allows for easy flush mounting.

1. Apply the adhesive mounting template sheet in the area that was verified to receive satellite signal well.
2. Then, following template instruction, drill a 1" (25 mm) hole and three 0,13" (3.2 mm) holes.

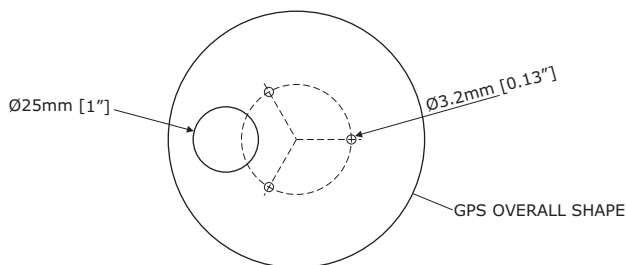

*Installing GPS Antenna (II)*

3. Remove the template and let the cable go through the central hole.
4. Apply a small coat of RTV to the underside of the antenna.
5. Place the antenna and then screw it with the three M3 screws.

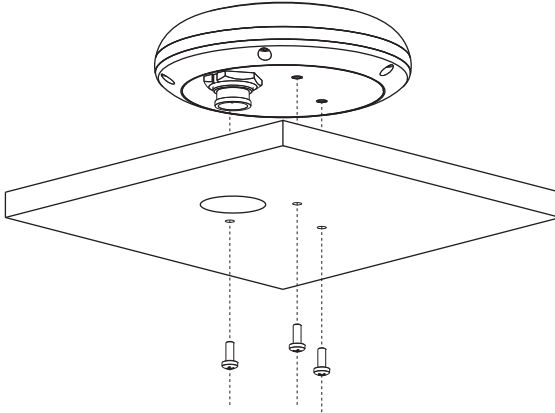

*Installing GPS Antenna (III)*

## DIMENSIONS

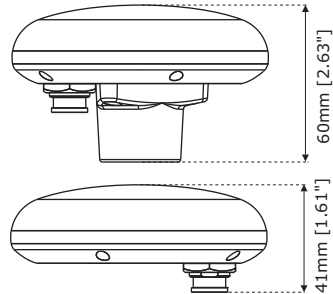
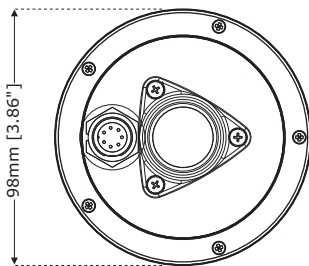

*GPS Antenna Dimensions*

# Analytical Index

---

3D Road .....	20	Cable Wiring pages .....	63
3D Road page .....	20, 27	Calibrate Aux Temperature .....	89
<b>A</b>		Calibrate Compass .....	63
A-B function .....	29	Calibrate Sound Speed .....	89
A-Scope .....	81	Calibrate Water Speed .....	89
activates navigation .....	29	Calibrate Water Temperature .....	89
Activating Track Recording .....	38	CARTOGRAPHY .....	23
Active Route .....	33	Cartography .....	133
Add screen video image .....	20	CAUTION .....	4
Add Video menu .....	60	Chain .....	95
ADD VIDEOCAMERA .....	20	Changing Chart Scale .....	28
AddVid .....	20	Chart .....	19
Advanced Options menu .....	61	Chart / Video .....	60
AIS .....	64	Chart Boundaries .....	57, 58
AIS Menu .....	65	Chart Display page .....	19, 26
AIS Report .....	66	Chart Language .....	22, 23, 53
AIS Symbols .....	65	Chart Lock .....	57, 58
Alarm .....	47, 64	CHART PLOTTER DIMENSIONS .....	133, 139
Alarm Bar .....	80	Chart Scale .....	28
Alarms Menu .....	90	Chart Settings .....	58
alphabetical table .....	20	Chart/Fish page .....	85
Alphanumeric Input .....	20	CLEAR .....	15, 16, 17
Alter .....	95	Clear Info .....	24
Altitude .....	22, 53, 95	Clear View .....	24
Altitude Units .....	22, 53	Clearing Track .....	39
Anchor Alarm .....	47	COG .....	60, 95
Antenna .....	149	Color .....	34
Arrival Alarm .....	47	Color Bar .....	80
Arrival Time .....	95	Color Settings .....	89
ASF .....	95	Compute Correction .....	63
ASSISTANCE .....	14	contrast .....	15, 22, 93
Attention Areas .....	57	CONTROLLER DIMENSIONS .....	145
Auto Info .....	40, 59	CONVENTION .....	13
Auto Info on MOB .....	30	Coordinate System .....	59
Auto Off .....	47	Coordinates .....	46
Automatic Info .....	40	Correction Offset .....	63
Automatic Route Check .....	36	Course Line .....	59, 95
Autopilot Connection .....	61, 141, 146	Course To Steer .....	96
AUX In I/O Cable Wiring .....	63	CPA .....	64
AUX IN I/O Connector .....	135	CPA Alarm .....	66
AWD .....	95	Creating a Route .....	33
AWS .....	95	Creating Event .....	31
Azimuth .....	95	Creating Mark .....	31
<b>B</b>		Creating Waypoint .....	31
backlight .....	15, 16, 17, 22, 93	CTS .....	96
Bathymetric .....	24	Cultural Features .....	96
Beacon .....	95	Currents Prediction .....	56
Bearing .....	63, 95	Cursor .....	46
Boat Position .....	28	Cursor Control .....	25
Bottom Echo Profile .....	82	Cursor Speed .....	22, 53
Bottom Range .....	88	Cursor Window .....	60
boundary .....	133	customize data field .....	15
BRG .....	95	<b>D</b>	
Buoy .....	95	DATA .....	15, 16, 25
Buoys and Beacons .....	95	Data Features .....	23
BWC .....	59	DATA MEDIA .....	25
<b>C</b>		Data Safety Indicator (DSI) .....	55
C-COM .....	62, 66, 93	Data Window Mode .....	40, 59
C-COM Connector .....	135	date (simulation) .....	25
C-COM GSM Plus Connection .....	62, 141, 148	Date Format .....	22, 53
C-Link .....	63, 73, 74	Datum .....	59, 96
C-Link menu .....	63	Daylight Saving Time .....	22, 53
C-Weather Service .....	66	Deactivating Track Recording .....	38

Dead Reckoning .....	96	Expanded Info page .....	42
Dedicated Keys .....	15, 16, 17	External Alarm .....	94
Deep Water .....	90	External Alarm Connection .....	141, 147
Default .....	96	External Alarm Connector .....	134
Deleting A-B .....	29	External NMEA Connection .....	61, 141, 147
Deleting destination .....	37	External Signal .....	49, 62
Deleting File .....	50	EXTERNAL WIRING .....	104, 110, 116, 122, 128, 134, 140, 146
Deleting MOB .....	30	External WPT .....	59
Deleting R/B .....	29	Extra Large Coverage .....	24
Deleting Route .....	34	<b>F</b>	
Deleting User Point .....	31	FEATURES .....	24, 101, 107, 113, 119, 125
DEPTH .....	20	FEATURES & FUNCTIONS .....	131, 137, 143
Depth .....	22, 26, 53, 88	FF and Chart page .....	20
Depth Alarm .....	47	FF Dual .....	20
Depth Area .....	96	FF Dual Frequency page .....	20
DEPTH FULL .....	20	FF Full page .....	20
Depth Graph Full page .....	20, 26	FF MODULE .....	108, 120
Depth Graph page .....	20, 26	FF Splt .....	20
Depth Line .....	96	FF Std .....	20
Depth Range Max .....	57, 58	FF Zoom page .....	20
Depth Range Min .....	57, 58	FF+Map .....	20
Depth Ruler .....	80	File .....	49, 96
Depth Settings .....	58	Find .....	24, 32
Depth Units .....	22, 53	Find Coordinates .....	46
Depths .....	24	Find Cursor .....	46
destination .....	15, 29, 37, 96	Find function .....	45
Detailed Port Plan .....	24	Find Lakes By Name .....	46
Detailed World Background .....	24	Find Lakes Information .....	46
Devices .....	22	Find Obstructions .....	46
DGPS .....	96	Find Points Of Interest .....	46
Diff. Corr. Source .....	61	Find Port By Distance .....	45
Differential GPS .....	96	Find Port By Name .....	45
Diffusers .....	36, 57, 59	Find Port Services .....	45
Digital Depth .....	80	Find Tide Station .....	45
DIM Menu .....	93	Find User Points .....	46
DIMENSIONS .....	103, 109, 115, 121, 127	Find Wrecks .....	45
Display (AIS) .....	66	First Setup page .....	21, 22
Display Mode .....	57	Fish Alarm .....	90
Display Options menu .....	59	FISH FINDER .....	20
Display Setup Menu .....	89	Fish Finder .....	61, 71, 79, 85
Displaying Track .....	38	Fish Finder Full page .....	83
Distance .....	22, 37, 38, 53, 96	Fish Finder page .....	80
Distance (track) .....	38	Fish Finder Page selection .....	82
Distance Units .....	22, 53	Fish Finder Setup menu .....	87
Distress Call .....	68	Fish Finder Transmission .....	61, 79
DPT .....	96	Fish Symbols .....	89
Dredged Areas .....	36	Fishes .....	81
DSC .....	68	Fishing Facility .....	36
DSC Directory page .....	70	Fix .....	96
DSC Log page .....	69	Fix & Compass menu .....	63
DST .....	96	Fix Correction .....	63
Dual Frequency page .....	84	Fix Datum .....	59
Dynamic Currents .....	24	Fix Status .....	97
Dynamic Elevation Data .....	24	Flexi-Zoom .....	24, 53
Dynamic Nav-Aids .....	24, 54	Following a Route .....	34
<b>E</b>		Fonts & Symbols .....	53
EBL/VRM function .....	29	Forecast .....	67
Echogram display .....	81	Formatting USER MEDIA .....	49
Echogram window .....	80	Freq Soft Key .....	87
Editing R/B .....	30	Frequency .....	88, 89
Editing User Point .....	31	Fuel (Route Report) .....	35
Enhanced Mixing Levels .....	24	Fuel Consumption Rate .....	97
Enhanced Turbo-Zoom .....	24	Full Info .....	40, 42
ENTER .....	15, 16, 17	Full Screen Video .....	60
ETA .....	96	Full Screen Video 1 + Video 2 .....	60
EVENT .....	16, 20, 31	Full Screen Video 2 + Video 1 .....	60
Event .....	20, 31	Full screen video image .....	20
Event Handler Type .....	59	Function Keys .....	19
Event place .....	20	Function Keys Customization .....	19
Expanded Info .....	40		

<b>G</b>	
Gain .....	89
Gain Mode .....	88
Gain Soft Key .....	87
Gauges .....	20
Gauges page .....	20, 28
General Options menu .....	53
GNSS .....	97
GOTO .....	16, 37
Goto .....	15, 97
GPS .....	27, 61, 91, 97, 149
GPS Antenna Dimensions .....	150
GPS Cable Wiring .....	63
GPS Connection .....	61, 134, 140, 146
GPS Connector .....	134
GPS constellation .....	91
GPS Setup Menu .....	61
GPS STATUS .....	20
GPS Status page .....	20, 21, 27
Grounding Alarm .....	48
Grounding Alarm Range .....	48
Grounding Alarm Report .....	48
Guardian Alarm .....	24
<b>H</b>	
HDG .....	97
HDOP .....	47, 92, 97
HDOP Alarm .....	47
Head Up .....	28, 54
Heading .....	97
Heading (simulation) .....	25
Heading Alarm .....	47
Hiding Route .....	34
High Water Temp .....	90
Home .....	15, 16, 17, 18, 28
Home mode .....	97
<b>I</b>	
I/O Port 1-2 .....	63
I/O Port 3 - GPS .....	63
I/O Port 4-5 .....	63
Icon (User Point) .....	31
INFO .....	16
Info .....	40
Info on Pictures .....	40
Info Tree .....	42
input port .....	32, 35
Input/Output menu .....	61
Inserting A-B .....	29
Inserting MOB .....	30
Inserting notes .....	33
Inserting R/B .....	29
Inserting the MEDIA .....	102, 109, 114, 121, 127, 132
Inserting Waypoint .....	35
INSERTING/REMOVING PROCEDURE .....	132, 138, 144
INSTALLATION .....	103, 109, 115, 122, 127
INSTALLATION AND REMOVING .....	134, 139, 145
Installing GPS Antenna .....	149
Int.Rej. Soft Key .....	87
Interference Rejection .....	88
Internal GPS .....	61
Intertidal Areas .....	36
ISO Certification .....	23
<b>J</b>	
Joystick .....	15, 16, 17
<b>K</b>	
Keel Offset .....	89
KEYBOARD .....	15
Keypad Beep .....	22, 53
<b>L</b>	
Lakes .....	42
Lakes By Name .....	46
Lakes Information .....	46
Land Area .....	36
Land Elevations .....	24, 57, 58
Land Elevations Values .....	57, 58
Land Settings .....	58
Landmarks .....	97
Language .....	22, 23, 53
Large size font .....	54
LAT/LON .....	97
Lat/Lon Grid .....	57, 58, 97
Latitude .....	97
List .....	31
Load Settings .....	90
Loading File .....	50
Local Time .....	53
Locating User Point .....	32
LOG Speed .....	97
Longitude .....	97
Look Ahead .....	59
Loran .....	97
Low Water Temp .....	90
<b>M</b>	
Magnetic Deviation .....	97
Magnetic Variation .....	63, 97
main Menu .....	15
Maintenance .....	93
Man OverBoard .....	15, 16, 17, 18, 30
Map Datum .....	59
Map Options menu .....	53
Map Orientation .....	28, 54
Map Scale .....	99
Marine Settings .....	57
MARK .....	16, 20, 31
Mark .....	15, 20, 31, 98
Mark place .....	20
Master reset .....	21
MAX .....	23, 25
MEDIA .....	93, 102, 108, 114, 120, 126, 132
MENU .....	15, 16, 17
meteo .....	66
Mixing Levels .....	24, 55
MMSI .....	64, 66, 68, 70
MOB .....	15, 16, 17, 18, 30, 75
Modem test .....	93
Mooring .....	36
Moving User Point .....	32
Multilanguage Support .....	24
<b>N</b>	
Name Tags .....	57
Natural Features .....	98
Nav Aids & Light Sectors .....	57
Nav Data .....	19
Nav-Aids .....	54
Nav-Aids & Light Sectors .....	57
Nav-Aids Presentation .....	22, 53
Navigate .....	15, 16, 17, 18
Navigate mode .....	98
NAVIGATION .....	19
Navigation .....	34
Navigation Data page .....	19, 27
Navigation Speed .....	61
Navigation to Waypoint .....	37
Night Vision .....	56
NMEA input port .....	32, 35
NMEA output port .....	35
NMEA-0183 .....	98
NMEA-0183 Output Talker ID .....	62
NOAA .....	22, 53, 56
Normal size font .....	54
North Up .....	28, 54

<b>O</b>	
Object Info .....	24
Obstructions .....	36, 57, 59
Off-line redraw .....	24
Official data source .....	24
Operating Frequency .....	81
opto-isolated .....	4
OSGB .....	98
Other Map Configurations .....	57
output port .....	35
Output Sentences .....	62
<b>P</b>	
package .....	132, 138
PAGE .....	15
Page .....	25, 69, 70, 71
Page selection menu .....	25
Pair .....	98
Palette .....	56
PC Planner .....	66
Perspective View .....	24, 54
Photos & Diagrams .....	24
Pictures .....	40
Pictures & Diagrams .....	98
Pingos .....	36
Place Names .....	57
POI .....	57
Points Of Interest .....	46
POIs .....	58
Port By Distance .....	45
Port By Name .....	45
Port Info .....	24, 43, 98
Port Info icon .....	43
Port Services .....	45
Ports & Services .....	43, 57, 58, 98
Position Filter .....	63
Position Request .....	68
POWER .....	15, 16, 17
Power and I/O Connector .....	134
Power I/O Cable Wiring .....	63
Presentation Features .....	24
Preset Mode .....	88
Primary Station .....	74
Production Installation .....	36
<b>Q</b>	
Quick Disconnect Cable Wiring .....	63
Quick Info .....	24, 40, 42, 77
Quick Info on AIS Target .....	66
Quick Info on DSC Icons .....	70
<b>R</b>	
R/B .....	29
RADAR .....	20
Radar .....	71, 85
Radar and Chart page .....	20
Radar and data page .....	20
Radar and FF page .....	20
Radar, FF, Chart and data page .....	20
Radar Full page .....	20
Radar/FF page .....	85
Radar/FF/Chart/Nav Data .....	85
Radar/FF/Chart/Video .....	61
Radar/FF/Chart/Video 1 .....	60
Radar/FF/Chart/Video 2 .....	60
RAM Menu .....	93
Range and Bearing .....	29
Range Mode .....	88
Range Soft Key .....	87
Range/Bearing function .....	29
Rd Std .....	20
Rd+Data .....	20
Rd+FF .....	20
Rd+Map .....	20
Reading directory .....	50
Receive Routes & Marks .....	63
Receiving Route .....	35
Receiving User Point .....	32
Removing the MEDIA .....	103, 105, 109, 115, 121, 127, 133
Resolution angle .....	28
Restart GPS .....	61
Restore Current Preset Defaults .....	90
Reversing Route .....	35
Roads .....	57, 58
Rocks .....	36, 57, 59
ROUTE .....	16
Route .....	31, 32, 33, 34, 35, 36, 75, 98
Route Check Accuracy .....	37
Route Check Report .....	36
Route Color .....	34
Route Data Report .....	76
Route Depth .....	36
Route Number .....	40
Route Report page .....	35
Route Width .....	36
RTCM .....	99
RTE .....	35
<b>S</b>	
Safe Route Checking .....	35
Safety Route Check .....	24
Safety Status Bar .....	55
Safety Toolbar .....	24
satellite .....	91
Satellite Imagery .....	56
Save & Load .....	49
Save & Load Menu .....	90
Save Settings .....	90
Saving File .....	49
Scale .....	99
screen .....	4
Screen Amplifier .....	28, 59
Scrolling Speed .....	89
SD Card .....	102, 108, 114, 120, 132
Seabed Type .....	57, 58
Search & Find .....	24
Secondary Station .....	74
Select Route menu .....	34
Selecting Slot .....	50
Send Routes & Marks .....	63
Sending Route .....	35
Sending User Point .....	32
Sensitivity Menu .....	89
serial port .....	4
Serial Ports .....	94
Shallow Water .....	36, 90
Shift .....	88
Ship Icon Mode .....	59
Shoreline Constructions .....	36
Showing Route .....	34
SIM Pin .....	67
Simulation Mode .....	22, 25
Simulator function .....	25
Smooth-Zoom .....	24
SNR .....	99
Soft Key .....	18, 82, 87
Soft Key Customization .....	19
Software Keys .....	18
Software Keys Customization .....	19, 20
software version .....	21
SOG .....	99
Sorting directory .....	51
SPECIFICATIONS .....	102, 108, 114, 120, 126



Speed	22, 53	TWD	99
Speed (Route Report)	35	TWS	99
Speed (simulation)	25	TYPICAL CONNECTIONS ..	104, 110, 117, 123, 128, 140, 146
Speed Filter	63	<b>U</b>	
Speed Units	22, 53	Underwater Objects	99
Spot Soundings	24, 99	Underwater Objects Limit	57, 59
Static Navigation	63	Underwater Objects Settings	58
Status	20	Unit	22, 53
STC	89	User Data	15
STC Length	89	USER MEDIA	49
STC Soft Key	87	USER MEDIA Menu	49
STC Strength	89	USER MEDIA page	49
Step Unit	38	User Point	31, 32, 46, 59, 100
STR	99	User Point presentation	31
Structures	82	User Points List page	31, 32
STW = Speed Through Water	99	UTC	53, 100
Surf Noise Filter	89	UTM	100
Surface Clutter	82	<b>V</b>	
Switching Off	21	VAD	58
Switching On	21	Value-Added Data	57, 58
Symbol Size	59	Variable Depth Marker	81
System Information	71	Variation	100
System Test	93	VDM	81
<b>T</b>		Video	20
Talker ID	62	Video 1	20, 60
Target (AIS)	65	Video 2	20, 60
TCPA	64	Video Input Connector	135
TCPA Alarm	66	Video Input menu	60
TD	99	VIDEO MODE	60
TECHNICAL SPECIFICATIONS	132, 138, 144	Video Output Connector	135
Temperature	22	VIDEOCAMERA	20
Temperature Units	22, 53	Visual COG Bar	60
Terms	95	VMG	100
Text Area	40	voltage	21
Thermoclines	81	<b>W</b>	
Tide	99	WAAS	100
Tide Graph page	44	WARNING	4
Tide Info	44, 99	Warning Message (FF)	80
Tide Info icon	44	warning page	21
Tide Station	44, 45	Warping Facility	36
Tides & Currents	57	Water Temp Rate	90
Tides Preview	24	Water Temperature	80, 89
Time	37	WAYPOINT	20
time (simulation)	25	Waypoint	15, 20, 31, 33, 35, 37, 100
Time (track)	38	Waypoint place	20
Time Difference	99	Weather data package	66
Time Format	22, 53	weather forecast	66
Time Reference	22, 53	WGS-84	100
Time To Go	99	White Line	82, 89
Timer Alarm	48	Wind	22, 27
Timer Direction	48	WIND DATA	20
TRACK	16, 20	Wind Data page	20, 27
Track	20, 37	Wind Units	22, 53
Track Color	38	WindData	20
Track Number	39	worldwide background	24
Track Step	37	WPL	35
Track storing	20	Wrecks	36, 45, 57, 59
Track To Route	39	<b>X</b>	
Track Up	28, 54	XTE	47, 100
Tracks & Routes	57, 58, 99	XTE Alarm	47
transducer	90	<b>Z</b>	
Transducer Setup Menu	89	Zoom	24, 55, 86
TRN	99	Zoom Bar	81
True Wind Direction	99	ZOOM IN	15, 16, 17, 28, 53
True Wind Speed	99	ZOOM OUT	15, 16, 17, 28, 53
True-Type Font	24	Zoom page	84
TTG	99	Zoom Type	53
Turbo-Zoom	24	Zoom-In	100
turn Off	15, 16, 17	Zoom-Out	100
turn On	15, 16, 17		