

# KENWOOD

## NEXEDGE NX-230EX/ NX-330EX

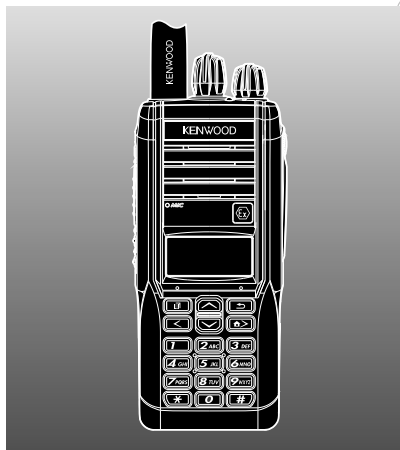

VHF DIGITAL TRANSCEIVER/ UHF DIGITAL TRANSCEIVER  
**INSTRUCTION MANUAL**

ÉMETTEUR-RÉCEPTEUR NUMÉRIQUE VHF/ ÉMETTEUR-RÉCEPTEUR NUMÉRIQUE UHF  
**MODE D'EMPLOI**

TRANSCPTOR DIGITAL VHF/ TRANSCPTOR DIGITAL UHF  
**MANUAL DE INSTRUCCIONES**

RICETRASMETTITORE DIGITALE VHF/ RICETRASMETTITORE DIGITALE UHF  
**MANUALE DI ISTRUZIONI**

VHF DIGITAL FUNKGERÄT/ UHF DIGITAL FUNKGERÄT  
**BEDIENUNGSANLEITUNG**

VHF DIGITALE ZENDONTVANGER/ UHF DIGITALE ZENDONTVANGER  
**GEbruIKSAANWIJZING**

VHF SAYISAL EL TELSİZİ/ UHF SAYISAL EL TELSİZİ  
**KULLANIM KILAVUZU**

ΨΗΦΙΑΚΟΣ ΠΟΜΠΟΔΕΚΤΗΣ VHF/ ΨΗΦΙΑΚΟΣ ΠΟΜΠΟΔΕΚΤΗΣ UHF  
**ΟΔΗΓΙΕΣ ΧΡΗΣΗΣ**

**JVCKENWOOD Corporation**

© B62-2449-00 (E)

09 08 07 06 05 04 03 02 01 00



VHF DIGITAL TRANSCEIVER/  
UHF DIGITAL TRANSCEIVER

**NX-230EX/ NX-330EX**

---

## INSTRUCTION MANUAL

JVCKENWOOD Corporation

**ENGLISH**

### NOTIFICATION

This equipment complies with the essential requirements of Directive 1999/5/EC.

The use of the warning symbol  means the equipment is subject to restrictions of use in certain countries.

This equipment requires a licence and is intended for use in the countries as below.

AT	BE	DK	FI	FR	DE	GR	IS	IE
IT	LI	LU	NL	NO	PT	ES	SE	CH
GB	CY	CZ	EE	HU	LV	LT	MT	PL
SK	SI	BG	RO	HR				

ISO3166



## THANK YOU

We are grateful you have chosen **KENWOOD** for your land mobile radio applications.

## NOTICES TO THE USER

- ◆ Government law prohibits the operation of unlicensed radio transmitters within the territories under government control.
- ◆ Illegal operation is punishable by fine and/or imprisonment.
- ◆ Refer service to qualified technicians only.

### Safety:

- ◆ It is important that the operator is aware of, and understands, hazards common to the operation of any transceiver.
- ◆ For use in explosive atmospheres, read additional document "SAFETY MANUAL FOR HAZARDOUS LOCATIONS" (B62-2450-XX).

### Information on Disposal of Old Electrical and Electronic Equipment and Batteries (applicable for countries that have adopted separate waste collection systems)



Products and batteries with the symbol (crossed-out wheeled bin) cannot be disposed of as household waste.

Old electrical and electronic equipment and batteries should be recycled at a facility capable of handling these items and their waste byproducts. Contact your local authority for details in locating a recycle facility nearest to you.



Proper recycling and waste disposal will help conserve resources whilst preventing detrimental effects on our health and the environment.

Notice: The sign "Pb" below the symbol for batteries indicates that this battery contains lead.

## PRECAUTIONS

- Do not charge the transceiver and battery pack when they are wet.
- Ensure that there are no metallic items located between the transceiver and the battery pack.
- Use only **KENWOOD** specified explosion-protected options for the NX-230EX and NX-330EX transceivers.
- If the die-cast chassis or other transceiver part is damaged, do not touch the damaged parts.
- Do not place the microphone cable around your neck while near machinery that may catch the cable.
- Do not place the transceiver on unstable surfaces.
- Ensure that the end of the antenna does not touch your eyes.
- When the transceiver is used for transmission for many hours, the radiator and chassis will become hot. Do not touch these locations when replacing the battery pack.
- Do not immerse the transceiver in water.
- Always switch the transceiver power off before installing optional accessories.
- The charger is the device that disconnects the unit from the AC mains line. The AC plug should be readily accessible.

**WARNING**

Turn the transceiver power off in the following locations:

- Near blasting sites.
- In aircrafts. (Any use of the transceiver must follow the instructions and regulations provided by the airline crew.)
- Where restrictions or warnings are posted regarding the use of radio devices, including but not limited to medical facilities.
- Near persons using pacemakers.

**CAUTION**

- Do not disassemble or modify the transceiver for any reason.
- Do not place the transceiver on or near airbag equipment while the vehicle is running. When the airbag inflates, the transceiver may be ejected and strike the driver or passengers.
- Do not transmit while touching the antenna terminal or if any metallic parts are exposed from the antenna covering. Transmitting at such a time may result in a high-frequency burn.
- If an abnormal odor or smoke is detected coming from the transceiver, switch the transceiver power off immediately, remove the battery pack from the transceiver, and contact your **KENWOOD** dealer.
- Use of the transceiver while you are driving may be against traffic laws. Please check and observe the vehicle regulations in your area.
- Do not expose the transceiver to extremely hot or cold conditions.
- Do not carry the battery pack with metal objects, as they may short the battery terminals.
- Danger of explosion if the battery is incorrectly replaced; replace only with the same type.

## Information concerning the battery pack:

The battery pack includes flammable objects such as organic solvent. Mishandling may cause the battery to rupture producing flames or extreme heat, deteriorate, or cause other forms of damage to the battery. Please observe the following prohibitive matters.



### DANGER

- **Do not disassemble or reconstruct battery!**

The battery pack has a safety function and protection circuit to avoid danger. If they suffer serious damage, the battery may generate heat or smoke, rupture, or burst into flame.

- **Do not short-circuit the battery!**

Do not join the + and – terminals using any form of metal (such as a paper clip or wire). Do not carry or store the battery pack in containers holding metal objects (such as wires, chain-necklace or hairpins). If the battery pack is short-circuited, excessive current will flow and the battery may generate heat or smoke, rupture, or burst into flame. It will also cause metal objects to heat up.

- **Do not incinerate or apply heat to the battery!**

If the insulator is melted, the gas release vent or safety function is damaged, or the electrolyte is ignited, the battery may generate heat or smoke, rupture, or burst into flame.

- **Do not leave the battery near fire, stoves, or other heat generators (areas reaching over 80°C)!**

If the polymer separator is melted due to high temperature, an internal short-circuit may occur in the individual cells and the battery may generate heat or smoke, rupture, or burst into flame.

- **Avoid immersing the battery in water or getting it wet by other means!**

If the battery becomes wet, wipe it off with a dry towel before use. If the battery's protection circuit is damaged, the battery may charge at extreme current (or voltage) and an abnormal chemical reaction may occur. The battery may generate heat or smoke, rupture, or burst into flame.



**DANGER**

- **Do not charge the battery near fire or under direct sunlight!**

If the battery's protection circuit is damaged, the battery may charge at extreme current (or voltage) and an abnormal chemical reaction may occur. The battery may generate heat or smoke, rupture, or burst into flame.

- **Use only the specified charger and observe charging requirements!**

If the battery is charged in unspecified conditions (under high temperature over the regulated value, excessive high voltage or current over regulated value, or with a remodeled charger), it may overcharge or an abnormal chemical reaction may occur. The battery may generate heat or smoke, rupture, or burst into flame.

- **Do not pierce the battery with any object, strike it with an instrument, or step on it!**

This may break or deform the battery, causing a short-circuit. The battery may generate heat or smoke, rupture, or burst into flame.

- **Do not jar or throw the battery!**

An impact may cause the battery to leak, generate heat or smoke, rupture, and/or burst into flame. If the battery's protection circuit is damaged, the battery may charge at an abnormal current (or voltage), and an abnormal chemical reaction may occur. The battery may generate heat or smoke, rupture, or burst into flame.

- **Do not use the battery pack if it is damaged in any way!**

The battery may generate heat or smoke, rupture, or burst into flame.

- **Do not solder directly onto the battery!**

If the insulator is melted or the gas release vent or safety function is damaged, the battery may generate heat or smoke, rupture, or burst into flame.

- **Do not reverse the battery polarity (and terminals)!**

When charging a reversed battery, an abnormal chemical reaction may occur. In some cases, an unexpected large amount of current may flow upon discharging. The battery may generate heat or smoke, rupture, or burst into flame.

**DANGER**

- **Do not reverse-charge or reverse-connect the battery!**  
The battery pack has positive and negative poles. If the battery pack does not smoothly connect with a charger or operating equipment, do not force it; check the polarity of the battery. If the battery pack is reverse-connected to the charger, it will be reverse-charged and an abnormal chemical reaction may occur. The battery may generate heat or smoke, rupture, or burst into flame.
- **Do not touch a ruptured and leaking battery!**  
If the electrolyte liquid from the battery gets into your eyes, wash your eyes with fresh water as soon as possible, without rubbing your eyes. Go to the hospital immediately. If left untreated, it may cause eye-problems.

**WARNING**

- **Do not charge the battery for longer than the specified time!**  
If the battery pack has not finished charging even after the regulated time has passed, stop it. The battery may generate heat or smoke, rupture, or burst into flame.
- **Do not place the battery pack into a microwave or high pressure container!**  
The battery may generate heat or smoke, rupture, or burst into flame.
- **Keep ruptured and leaking battery packs away from fire!**  
If the battery pack is leaking (or the battery emits a bad odor), immediately remove it from flammable areas. Electrolyte leaking from battery can easily catch on fire and may cause the battery to generate smoke or burst into flame.
- **Do not use an abnormal battery!**  
If the battery pack emits a bad odor, appears to have different coloring, is deformed, or seems abnormal for any other reason, remove it from the charger or operating equipment and do not use it. The battery may generate heat or smoke, rupture, or burst into flame.

# CONTENTS

UNPACKING AND CHECKING EQUIPMENT .....	1
PREPARATION .....	2
GETTING ACQUAINTED .....	4
PROGRAMMABLE FUNCTIONS .....	7
BASIC OPERATIONS .....	9
MENU MODE .....	12
SCAN .....	15
FleetSync: ALPHANUMERIC 2-WAY PAGING FUNCTION .....	17
5-TONE SIGNALING .....	20
ADVANCED OPERATIONS .....	22

---

---

## UNPACKING AND CHECKING EQUIPMENT

---

---

Carefully unpack the transceiver. If any items are missing or damaged, file a claim with the carrier immediately.

**Note:** These unpacking instructions are for use by your **KENWOOD** dealer, an authorized **KENWOOD** service facility, or the factory.

### SUPPLIED ACCESSORIES

Belt clip (KBH-16EX) .....	1
• Screws for belt clip (M3 x 10 mm) .....	2
Universal connector cap .....	1
• Dressing screw (preassembled) .....	1
• Packing (preassembled) .....	1
Instruction manual .....	1

---

---

## PREPARATION

---

---

### INSTALLING/ REMOVING THE (OPTIONAL) BATTERY PACK

- 1 Match the guides of the battery pack with the grooves on the upper rear of the transceiver, then firmly press the battery pack in place.
- 2 Lock the safety catch to prevent accidentally releasing the battery pack.
- 3 To remove the battery pack, lift the safety catch, press the release latch, then pull the battery pack away from the transceiver.

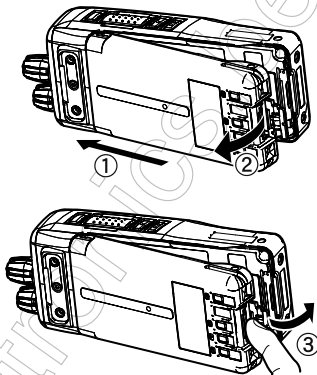

---

#### Note:

- ◆ For battery pack charging procedures and usage, refer to the battery charger Instruction Manual.
  - ◆ Before charging a battery pack that is attached to the transceiver, ensure that the safety catch is firmly closed.
  - ◆ While operating the transceiver using a Li-ion battery pack in areas with an ambient temperature of  $-10^{\circ}\text{C}/+14^{\circ}\text{F}$  and lower, operating time may be shortened.
- 

### INSTALLING THE (OPTIONAL) ANTENNA

Screw the antenna into the connector on the top of the transceiver by holding the antenna at its base and turning it clockwise until secure.

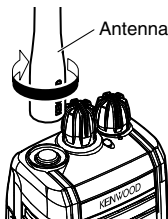

## INSTALLING THE BELT CLIP

Attach the belt clip using the supplied M3 x 10 mm screws.

**Note:** If the belt clip is not installed, its mounting location may get hot during continuous transmission or when left sitting in a hot environment.

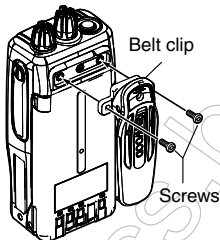

### CAUTION

Do not use glue which is designed to prevent screw loosening when installing the belt clip. Acrylic ester, which is contained in these glues, may crack the transceiver's back panel.

## INSTALLING THE CAP OVER THE UNIVERSAL CONNECTOR

Insert the cap into place over the universal connector and secure it in place using the attached screw.

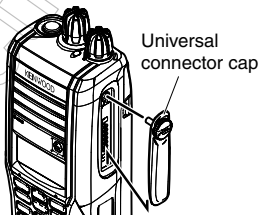

## INSTALLING THE (OPTIONAL) SPEAKER/ MICROPHONE

- 1 Insert the guide of the speaker/ microphone connector into place over the universal connector.
- 2 Secure the connector in place using the attached screw.

**Note:** When not using an optional speaker/ microphone, install the cap over the universal connector.

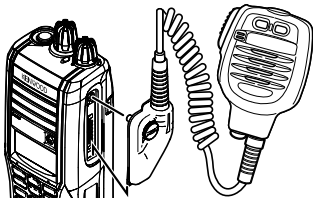

Speaker/ microphone

## GETTING ACQUAINTED

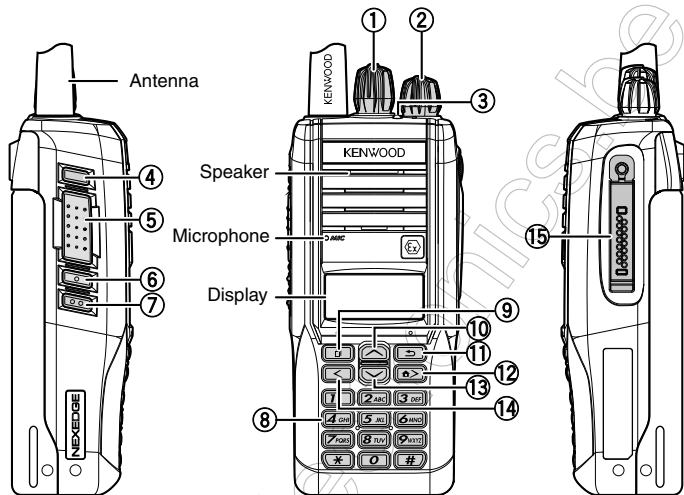

**① Selector knob**

Rotate to select a zone or channel/group ID (default).

**② Power switch/ Volume control**







Rotate to turn the transceiver ON/OFF and to adjust the volume.

**③ Transmit/ Receive/ Battery low indicator**

If enabled by your dealer, lights red while transmitting, green while receiving a call (Conventional channels only), and orange when receiving an optional signaling call. Blinks red when the battery power is low while transmitting.

**④ Auxiliary key**

Press to activate its programmable function {page 7}.

- ⑤ **PTT (Push-To-Talk) switch**  
Press and hold this switch, then speak into the microphone to call a station.
- ⑥ **Side 1 key**  
Press to activate its programmable function {page 7}.  
The default is Squelch Off Momentary.
- ⑦ **Side 2 key**  
Press to activate its programmable function {page 7}.  
The default is Backlight.
- ⑧ **Keypad**  
Press these keys to send DTMF tones. These keys can also be programmed with secondary functions {page 7} if a programmable function key is programmed as “Function”.
- ⑨  **key**  
Press to activate its programmable function {page 7}.  
The default is Menu.
- ⑩  **key**  
Press to activate its programmable function {page 7}.  
The default is Zone Up.
- ⑪  **key**  
Press to activate its programmable function {page 7}.
- ⑫  **key**  
Press to activate its programmable function {page 7}.
- ⑬  **key**  
Press to activate its programmable function {page 7}.  
The default is Zone Down.
- ⑭  **key**  
Press to activate its programmable function {page 7}.
- ⑮ **Universal connector**  
Connect a speaker/ microphone {page 3}. Otherwise, keep the supplied cap in place.

## DISPLAY



Indicator	Description
	Monitor or Squelch Off is activated.
	Blinks when an incoming call matches your Optional Signaling.
	The current zone (left icon) or CH/GID (right icon) is added to scan.
	Scan is in progress. Blinks while scan is paused.
	A message is stored in memory. Blinks when a new message has arrived.
	The current channel is a Priority channel.
	Operator Selectable Tone (OST) is activated.
	Signal strength indicator {page 27}.
	Battery power indicator {page 26}.
	Talk Around is activated.
	Site Lock is activated.
	Scrambler/ Encryption is activated.
	Lone Worker is activated.
	Activity Detection is activated.
MENU ZONE▲ MONI	Displays the key functions for  ,  , and .



---

---

## PROGRAMMABLE FUNCTIONS

---

---

Following is a list of available programmable functions. Please contact your dealer for further details on those functions which have been programmed on your transceiver.

- Activity Detection
- Activity Reset
- Autodial <sup>1</sup>
- Autodial Programming
- Backlight
- Broadcast <sup>2</sup>
- Call 1 ~ 6
- Call
- CH/GID Down
- Channel Entry
- CH/GID Recall
- CH/GID Up
- CW Message <sup>3</sup>
- Digit 1 × Down <sup>4</sup>
- Digit 10 × Down <sup>4</sup>
- Digit 1 × Up <sup>4</sup>
- Digit 10 × Up <sup>4</sup>
- Direct CH/GID 1 ~ 5
- Direct CH/GID Select 1 ~ 5
- Display Format
- Emergency <sup>5</sup>
- Fixed Volume
- Forced Search <sup>2</sup>
- Function
- Group ID/Channel Entry
- GPS Position Display
- Group (NXDN) <sup>6</sup>
- Group + SDM (NXDN) <sup>6</sup>
- Group + Status (NXDN) <sup>6</sup>
- Home CH/GID
- Home CH/GID Select
- Individual (NXDN) <sup>6</sup>
- Individual + SDM (NXDN) <sup>6</sup>
- Individual + Status (NXDN) <sup>6</sup>
- Key Lock
- Lone Worker
- Maintenance
- Menu
- Monitor <sup>7</sup>
- Monitor Momentary <sup>7</sup>
- Operator Selectable Tone <sup>7</sup>
- Priority-channel Select <sup>7</sup>
- Receive Entry <sup>4</sup>
- Scan
- Scan Delete/Add
- Scrambler/Encryption
- Scrambler/Encryption Code
- SDM (Analog/NXDN)
- Selcall (Analog) <sup>1</sup>
- Selcall + SDM(Analog) <sup>1</sup>
- Selcall + Status (Analog) <sup>1</sup>
- Send the GPS data
- Site Down <sup>2</sup>
- Site Lock <sup>2</sup>
- Site Up <sup>2</sup>
- Site Up/Down <sup>2</sup>
- Speaker Attenuation <sup>9</sup>
- Squelch Level <sup>8</sup>
- Squelch Off <sup>8</sup>
- Squelch Off Momentary <sup>8</sup>
- Stack
- Status (Analog/NXDN)
- Short Message
- Talk Around <sup>7</sup>

- Transceiver Password
- VOX <sup>7</sup>
- Zone Delete/Add
- Zone Down
- Zone Up

- <sup>1</sup> Available only for Analog Conventional and Analog Trunking operation.
- <sup>2</sup> Available only for NXDN Trunking operation.
- <sup>3</sup> Available only for NXDN Conventional operation.
- <sup>4</sup> Available only for 5-tone calls.
- <sup>5</sup> Can be programmed only on the Auxiliary key and the optional speaker/ microphone PF1 (orange) key.
- <sup>6</sup> Available only for NXDN Conventional and NXDN Trunking operation.
- <sup>7</sup> Available only for Analog Conventional and NXDN Conventional operation.
- <sup>8</sup> Available only for Analog Conventional operation.
- <sup>9</sup> Can be programmed only on the microphone programmable function keys.

---

---

## BASIC OPERATIONS

---

---



### SWITCHING POWER ON/OFF

Turn the **Power** switch/ **Volume** control clockwise to switch the transceiver ON.

Turn the **Power** switch/ **Volume** control counterclockwise fully to switch the transceiver OFF.

### ■ Transceiver Password

If the transceiver is password protected, "PASSWORD" will appear on the display when the power is turned ON. To unlock the transceiver, enter the password:





- 1 Select a character using  / .



  - You can enter the password directly.

- 2 Press  to enter the selected character.

  - This step is unnecessary when using the keypad.

- 3 Repeat steps 1 and 2 to enter the entire password.

  - Press  or  to delete a character. Press and hold  or  to delete all characters.

- 4 Press  or  to confirm the entry.

  - If you enter an incorrect password, an error tone sounds and the transceiver remains locked.
  - The password can contain a maximum of 6 digits.

### ADJUSTING THE VOLUME

Rotate the **Power** switch/ **Volume** control to adjust the volume. Clockwise increases the volume and counterclockwise decreases it.

## SELECTING A ZONE AND CHANNEL/GROUP ID

Select the desired zone using the key programmed as **[Zone Up]** / **[Zone Down]**. Each zone contains a group of channels.

Select the desired channel/group ID using the Selector knob (default). Each channel/group ID is programmed with settings for transmitting and receiving.

- You can toggle the display between the zone and channel/group ID names and number by pressing the key programmed as Display Format, or by accessing the Menu {Page12}.

---

**Note:** If the default settings for  /  and the Selector knob have been changed, use the appropriate keys to select the zone and channel/group ID.

---



## TRANSMITTING

- 1 Select the desired zone and channel/group ID.
- 2 Press the key programmed as **[Monitor]** or **[Squelch Off]** to check whether or not the channel is free.
  - If the channel is busy, wait until it becomes free.
- 3 Press the **PTT** switch and speak into the microphone. Release the **PTT** switch to receive.
  - For best sound quality, hold the transceiver approximately 1.5 inches (3 ~ 4 cm) from your mouth.

### ■ Making Group Calls (Digital)



If a key has been programmed with **[Group]**, **[Group + SDM]**, or **[Group + Status]**, you can select a group ID from the list to make a call to those parties on a Conventional channel.

To select a group ID:

- 1 Press the key programmed as **[Group]**, **[Group + SDM]**, or **[Group + Status]**.
- 2 Press  /  to select a group ID/name from the list.
- 3 Press and hold the **PTT** switch to make the call.
  - Speak into the transceiver as you would during a normal transmission.

## ■ Making Individual Calls (Digital)

If a key has been programmed with **[Individual]**, **[Individual + SDM]**, or **[Individual + Status]**, you can make calls to specific persons.

- 1 Press the key programmed as **[Individual]**, **[Individual + SDM]**, or **[Individual + Status]**.
- 2 Press  /  to select a unit ID from the list.
  - You can enter a unit ID directly.
- 3 Press and hold the **PTT** switch to make the call.
  - Speak into the transceiver as you would during a normal transmission.

## RECEIVING

Select the desired zone and channel. If signaling has been programmed on the selected channel, you will hear a call only if the received signal matches your transceiver settings.

---

**Note:** Signaling allows your transceiver to code your calls. This will prevent you from listening to unwanted calls. Refer to “SIGNALING” on page 25 for details.

---

## ■ Receiving Group Calls (Digital)

When you receive a group call on a Conventional channel and the received group ID matches the ID set up on your transceiver, you can hear the caller's voice.

When on a Trunking channel, if the Group ID of a received call matches your Group ID, you will hear the call.

## ■ Receiving Individual Calls (Digital)

When you receive an individual call, a ringing tone will sound and the caller's ID will appear on the display. To respond to the call, press and hold the **PTT** switch and speak into the transceiver as you would during a normal transmission.

---

---

















# MENU MODE

---

---

Many functions on this transceiver are selected or configured through the Menu instead of physical controls. Once you become familiar with the Menu system, you will appreciate the versatility it offers.

## MENU ACCESS

- 1 Press the key programmed as **[Menu]**.
  - The category list is shown.
  - When there is only 1 category, the function list is shown (proceed to step 4).
- 2 Press  /  to select a category item.
  - You can enter a category number directly.
- 3 Press  or  to view the function list.
- 4 Press  /  to select a function item.
  - You can enter a function number directly.
- 5 Press  or  to set up the selected function item.
  - Press  or  to return to the category list.
- 6 Press  /  to select your desired setting.
  - For settings with more than 1 level, repeat steps 5 and 6.
- 7 Press  or  to set the selected setting and exit Menu mode.
  - Press  or  at any time to return to the previous display.
  - Press  at any time to exit Menu mode.

## MENU CONFIGURATION

Some transceiver keys may already be programmed with functions listed in the Menu. Those functions can be accessed directly by pressing the key. All other functions can still be accessed using the transceiver Menu. The following table lists the available Menu items.



Display	Description
AUTO DIAL	Autodial Mode
AUTO DIAL PROG	Autodial Programming mode
BROADCAST	Broadcast ON/OFF
DIRECT CH1 SEL	Direct CH/GID 1 ~ 5 Select



<b>Display</b>	<b>Description</b>
DISP FORMAT	Display Format ON/OFF
EXT MIC TYPE	External Microphone Type mode
FIXED VOLUME	Fixed Volume
FORCED SEARCH	Forced Search
GPS POS DISP	GPS Position Display mode
GROUP	Group mode
GROUP+SDM	Group + Short Message mode
GROUP+STATUS	Group + Status mode
HOME CH SEL	Home CH/GID Select
INDIVIDUAL	Individual mode
INDIV+STATUS	Individual + Status mode
INDIV+SDM	Individual + Short Message mode
LONE WORKER	Lone Worker ON/OFF
MAINTENANCE	Maintenance Display mode
MONITOR	Monitor ON/OFF
OST	OST ON/OFF
OST LIST	OST mode
PRI CH SEL	Priority Channel Select mode
PASSWORD	Transceiver Password mode
RECEIVE ENTRY	Receive Entry mode
REDIAL	Redial Mode
RX AUDIO EQ	RX Audio Equalizer mode
RX AGC	RX Audio Gain Control mode
RX LOW CUT	RX Low Cut mode
SCAN	Scan ON/OFF
SCAN DEL/ADD	Scan Delete/Add
SCRAM/ENCRYP	Scrambler/Encryption ON/OFF
SCRAM CODE	Scrambler/Encryption Code mode
SELCALL	Selcall mode
SELCALL+STATUS	Selcall + Status mode
SELCALL+SDM	Selcall + Short Message mode
SEND GPS DATA	Transmit your GPS data
SITE LOCK	Site Lock ON/OFF
SITE No.	Display Site Number
SITE	Site Select Mode
SQUELCH LEVEL	Squelch Level mode
SQUELCH OFF	Squelch Off ON/OFF

Display	Description
STACK	Stack mode
STATUS	Status mode
SHORT MESSAGE	Short Message mode
TALK AROUND	Talk Around ON/OFF
TX AUDIO EQ	TX Audio Equalizer mode
TX AGC	TX Audio Gain Control mode
TX NOISE SUPPR	TX Noise Suppressor mode
ZONE DEL/ADD	Zone Delete/Add

## CHARACTER ENTRY

There are 2 methods available for entering characters:

- 1) Pressing the  /  keys

Press  /  to cycle the characters from A ~ Z, 0 ~ 9, and a space (default settings).

You can also assign a character to an optional key and later press that key to recall the assigned character: A ~ Z, a ~ z, 0 ~ 9, or a space and characters.

- 2) Using the Keypad

Press the keypad keys to enter characters as shown in the table below:

DTMF Key	Character Cycle
1	1
2	A B C 2
3	D E F 3
4	G H I 4
5	J K L 5
6	M N O 6
7	P Q R S 7
8	T U V 8
9	W X Y Z 9
0	[space] 0



---

---

## SCAN

---

---

Scan monitors for signals on the transceiver channels. While scanning, the transceiver checks for a signal on each channel and only stops if a signal is present.

To begin scanning, press the key programmed as **[Scan]**.

- The  icon appears on the display.
- When a signal is detected on a channel, Scan pauses at that channel. The transceiver will remain on the busy channel until the signal is no longer present, at which time Scan resumes.

To stop scanning, press the **[Scan]** key again.

---

**Note:** To use Scan, there must be at least 2 channels in the scan sequence.

---

### TEMPORARY CHANNEL LOCKOUT

During scan, you can temporarily remove specific channels from the scanning sequence by selecting them and pressing the key programmed as **[Scan Delete/Add]**.

- The channel is no longer scanned. However, when scanning is ended and restarted, the channels are reset and deleted channels will again be in the scanning sequence.

### PRIORITY SCAN

---

**Note:** To use Priority Scan, a Priority channel must be programmed.

---

When using a single Priority channel, the transceiver will automatically change to the Priority channel when a call is received on that channel, even if a call is being received on a normal channel.

When using dual Priority channels, Priority channel 1 is given precedence over Priority channel 2. So, if a call is received on Priority channel 1 while a call is already on Priority channel 2, the transceiver will change to Priority channel 1.

## SCAN REVERT

The Scan Revert channel is the channel selected when you press the **PTT** switch to transmit during scan. Your dealer can program one of the following types of Scan Revert channels:

- **Selected:** The last channel selected before scan.
- **Selected + Talkback:** Same as “Selected”, plus you can respond to calls on the channel at which scan is paused.
- **Priority 1/ Priority 2:** The Priority channel (either Priority 1 or Priority 2) .
- **Priority 1 + Talkback/ Priority 2 + Talkback:** Same as “Priority 1/ Priority 2”, plus you can respond to calls on the channel at which scan is paused.
- **Last Called + Selected:** The last channel on which you receive a call.



## SCAN DELETE/ADD

You can add and remove zones and/or channels/group IDs to and from your scan list.

- 1 Select your desired zone and/or channel/group ID.
- 2 Press the key programmed as **[Zone Delete/Add]** (to add/remove zones) or **[Scan Delete/Add]** (to add/remove channels/group IDs).
  - You can also press and hold the key programmed as **[Scan Delete/Add]** to add/remove zones.

## PRIORITY-CHANNEL SELECT

If the Priority channel has been set as Operator Selectable by your dealer, you can reprogram the Priority channels.

- 1 Select your desired zone and channel/group ID.
- 2 Press the key programmed as **[Priority-channel Select]**.
- 3 Press  /  to select “NORMAL”, “PRIORITY 1” ( **P<sup>1</sup>** ), “PRIORITY 2” ( **P<sub>2</sub>** ), or “PRIORITY 1&2” ( **P<sup>1&2</sup>** ).
- 4 Press  to save the setting and exit.

---

---

## FleetSync: ALPHANUMERIC 2-WAY PAGING FUNCTION

---

---

FleetSync is an Alphanumeric 2-way Paging Function, and is a protocol owned by JVC KENWOOD Corporation.



**Note:** This function is available only in analog operation.

---

### SELCALL (SELECTIVE CALLING)

A Selcall is a voice call to a station or group of stations.

#### ■ Transmitting

- 1 Select your desired zone and channel.
- 2 Press the key programmed as **[Selcall]**, **[Selcall + SDM]** or **[Selcall + Status]** to enter Selcall mode.
- 3 Press  /  to select the station you want to call.
  - If Manual Dialing is enabled, you can directly enter the station ID.
- 4 Press the **PTT** switch and begin your conversation.

#### ■ Receiving

An alert tone will sound and the transceiver will enter Selcall mode. The calling station's ID will appear when a Selcall is received. You can respond to the call by pressing the **PTT** switch and speaking into the microphone.

#### ■ Identification Codes

An ID code is a combination of a 3-digit Fleet number and a 4-digit ID number. Each transceiver has its own ID.

- Enter a Fleet number (100 ~ 349) to make a fleet call.
- Enter an ID number (1000 ~ 4999) to make an individual call in your fleet.
- Enter a Group ID (which is programmed in the FPU) to make a group call.
- Enter a Fleet number followed by an ID number to make an individual call in your desired fleet (Inter-fleet call).
- Select "ALL" Fleet and "ALL" ID to make a call to all units (Broadcast call).
- Select "ALL" Fleet and enter an ID number to make a call to the













selected ID in all fleets (Supervisor call).

## STATUS MESSAGE

You can send and receive 2-digit Status messages which may be decided in your talk group. Messages can contain up to 16 alphanumeric characters. Status messages range from 10 to 99 (80 ~ 99 are reserved for special messages).

A maximum of 15 received messages (combined status messages and short messages) can be stored in the stack memory of your transceiver.













### ■ Transmitting

- 1 Select your desired zone and channel.
- 2 Press the key programmed as **[Status]** to enter Status mode (proceed to step 5) or **[Selcall + Status]** to enter Selcall mode (proceed to step 3).
- 3 Press  /  to select the station you want to call.
  - If Manual Dialing is enabled, you can enter a station ID by using the Keypad, or by using  /  When using  / , cycle through the digits to select a digit, then press  to set the digit and move the cursor to the right. Repeat this process until the entire ID is entered.
- 4 Press  to enter Status mode.
- 5 Press  /  to select the status you want to transmit.
  - If Manual Dialing is enabled, you can enter a status ID by using the Keypad, or by using  /  (refer to step 3, above).
- 6 Press the **PTT** switch or **Side 2** key to initiate the call.
  - “<COMPLETE>” appears on the display when the status has been successfully transmitted.

## ■ Receiving

A calling ID or text message will appear when a Status call is received. Press any key to return to normal operation.

## ■ Reviewing Messages in the Stack Memory

- 1 Press the key programmed as **[Stack]**, or press and hold the key programmed as **[Selcall]**, **[SDM]**, **[Status+SDM]**, **[Status]**, or **[Selcall + Status]** to enter Stack mode.
  - The last received message is displayed.
- 2 Press  /  to select the desired message.
  - Message types are identified as follows:  
I: Caller ID, S: Status Message, M: Short Message
  - Press and hold  for 1 second or press  to cycle the display information as follows:  
ID Name > Status/Short Message > CH/GID > Time Stamp
- 3 Press  to return to normal operation.
  - To delete the selected message, press  or . To confirm the deletion, press  or .
  - To delete all messages, press and hold  or  for 1 second. To confirm the deletion, press  or .

## SHORT/LONG MESSAGES

Received short messages are displayed the same as Status messages and are stored in the same stack memory.

To send short messages, and to send and receive long messages, you must connect the transceiver to a PC. Ask your dealer for details.

## GPS REPORT

To send your location data. GPS data can be manually transmitted by pressing the key programmed as **[Send the GPS data]**, or by accessing the Menu {Page12}. If set up by your dealer, GPS data may be automatically transmitted at a preset time interval.

---

---

## 5-TONE SIGNALING

---



---

5-tone Signaling is enabled or disabled by your dealer. This function opens the squelch only when the transceiver receives the 5 tones programmed in your transceiver. Transceivers that do not transmit the correct tones will not be heard.

### SELCALL (SELECTIVE CALLING)

A Selcall is a voice call to a station or group of stations.

#### ■ Transmitting

- 1 Select your desired zone and channel.
- 2 Press the key programmed as **[Selcall]**, **[Selcall + Status]** or **[Selcall + SDM]** to enter Selcall mode.
- 3 Press  /  to select the station you want to call.
  - You can directly enter the station ID.
- 4 Press the key programmed as **[Call 1]** to **[Call 6]** and begin your conversation.

---

**Note:** Additionally, you can also use the keys programmed as **[Digit 1x Down]**, **[Digit 1x Up]**, **[Digit 10x Down]**, and **[Digit 10x Up]** keys to adjust the Selcall number. **[Digit 1x Up/Down]** increases/decreases the Selcall number by 1 each time the key is pressed. **[Digit 10x Up/Down]** increases/decreases the Selcall number by 10 each time the key is pressed.

---

#### ■ Receiving









When you receive a call containing the correct tones, the transceiver will enter Selcall mode. An alert tone will sound and the calling station's ID appear on the display. Press any key to return to normal operation.

### STATUS MESSAGE

You can send and receive Status messages which may be decided in your talk group. Messages can contain up to 16 alphanumeric characters.

A maximum of 15 received messages can be stored in the stack memory of your transceiver.













## ■ Transmitting

- 1 Select your desired zone and channel.
- 2 Press the key programmed as **[Status]** to enter Status mode (proceed to step 5) or **[Selcall + Status]** to enter Selcall mode (proceed to step 3).
- 3 Press  /  to select the station you want to call.
  - You can enter a station ID by using the Keypad, or by using  / .
- 4 Press  to enter Status mode.
- 5 Press  /  to select the status you want to transmit.
  - You can enter a status ID by using the Keypad, or by using  /  (refer to step 3, above).
- 6 Press the key programmed as **[Call 1]** to **[Call 6]** to initiate the call.

## ■ Receiving

A calling ID or text message will appear when a Status call is received. Press any key to return to normal operation.

## ■ Reviewing Messages in the Stack Memory

- 1 Press the key programmed as **[Stack]** to enter Stack mode.
  - The last received message is displayed.
- 2 Press  /  to select the desired message.
  - Press and hold  for 1 second or press  to cycle the display information as follows:  
Selcall Name > Status Name > CH/GID
- 3 Press  to return to normal operation.
  - To delete the selected message, press  or . To confirm the deletion, press  or .
  - To delete all messages, press and hold  or  for 1 second. To confirm the deletion, press  or .

---

---

# ADVANCED OPERATIONS

---

---



## DTMF (DUAL TONE MULTI FREQUENCY) CALLS

### ■ Making a DTMF Call

#### Manual Dialing



- 1 Press and hold the **PTT** switch.
- 2 Enter the desired digits using the Keypad.
  - If you release the **PTT** switch, transmit mode will end even if the complete number has not been sent.
  - If the Keypad Auto PTT function has been enabled by your dealer, you do not need to press the **PTT** switch to transmit; you can make the call simply pressing the DTMF keys.

#### Store & Send

- 1 Press the key programmed as [**Autodial**].
- 2 Enter up to 30 digits using the Keypad.
  - Alternatively, you can enter digits by using  / .
- 3 Press the **PTT** switch to make the call.

### ■ Autodial

Autodial allows you to quickly call DTMF numbers that have been programmed onto your transceiver.

- 1 Press the key programmed as [**Autodial**], or access the Menu {Page12}.
  - The first entry in the Autodial list appears on the display.
- 2 Press  /  to select your desired Autodial list number, or enter the list number directly (01 ~ 32).
  - The stored entry appears on the display.
- 3 Press the **PTT** switch to make the call.



## ■ Stun Code

This function is used when a transceiver is stolen or lost. When the transceiver receives a call containing a stun code, the transceiver becomes disabled. The stun code is cancelled when the transceiver receives a call with a revive code.

## EMERGENCY CALLS

If your transceiver has been programmed with the Emergency function, you can make emergency calls.

- 1 Press and hold the key programmed as **[Emergency]**.
  - Ask your dealer for the length of time necessary to hold this key before the transceiver enters Emergency mode.
  - When the transceiver enters Emergency mode, it will change to the Emergency channel and begin transmitting based on how it is set up by your dealer.
- 2 To exit Emergency mode, press and hold the **[Emergency]** key again.
  - If the Emergency mode completes a preset number of cycles, Emergency mode will automatically end and the transceiver will return to the zone and channel that was in use before Emergency mode was entered.

---

### Note:

- ◆ Your dealer can set the transceiver to emit a tone when transmitting in Emergency mode.
  - ◆ Your dealer can set the transceiver to emit tones and received signals as normal, or mute the speaker during Emergency operation.
  - ◆ **[Emergency]** can be programmed only on the Auxiliary (orange) key and the optional speaker/ microphone PF1 (orange) key.
-

## ACTIVITY DETECTION

Press the key programmed as **[Activity Detection]** to Activity Detection On and Off. If an event occurs while Activity Detection is enabled, for instance, if the transceiver remains in the tilt or stationary state or is excessively in motion longer than the preconfigured time, the transceiver enters Emergency Mode.

---

### Note:

- ◆ When Activity Detection has been turned off, and the transceiver power is then turned off and back on, Activity Detection is automatically enabled.
  - ◆ When using this function, verify that it operates before taking the transceiver.
- 

### ■ Activity Reset

While Activity Detection is active, press the key programmed as **[Activity Reset]** to reset the Activity Detection countdown timer. This will allow you to remain in a tilted or stationary position, etc., Without the Emergency mode activating unnecessarily.

## SCRAMBLER/ ENCRYPTION

Press the key programmed as **[Scrambler/ Encryption]**, or access the Menu {Page12}, to switch the transceiver to secure (encrypted) transmission.

- Pressing the **PTT** switch after the Scrambler function has been turned ON encrypts the transmitted signal.



## SIGNALING

### ■ Quiet Talk (QT)/ Digital Quiet Talk (DQT)

Your dealer may have programmed QT or DQT signaling on your transceiver channels. A QT tone/ DQT code is a sub-audible tone/code which allows you to ignore (not hear) calls from other parties who are using the same channel.

### Operator Selectable Tone (OST)

If a key has been programmed with [OST], you can reprogram the QT/DQT settings on each of your channels.

- 1 Select your desired channel.
- 2 Press and hold the key programmed as [OST] for 1 second.
- 3 Press  /  to select your desired tone or code.
  - Your dealer can set up to 40 tones/codes.
- 4 Press  to save your new setting.
- 5 When you have finished operating using OST, press the [OST] key again to turn the OST function OFF.

### ■ Radio Access Number (RAN)

RAN is a signaling system designed for digital radio communications.

When a channel is set up with a RAN, squelch will only open when a call containing a matching RAN is received. If a call containing a different RAN is made on the same channel you are using, you will not hear the call. This allows you to ignore (not hear) calls from other parties who are using the same channel.

## ■ Optional Signaling

Your dealer may also program several types of optional signaling for your transceiver channels.

**5-tone Signaling:** Refer to “SELCALL (SELECTIVE CALLING)” on page 20.

**DTMF Signaling :** DTMF Signaling opens the squelch only when the transceiver receives a call containing a matching DTMF code.

**FleetSync Signaling :** Refer to “SELCALL (SELECTIVE CALLING)” on page 17.

**NXDN ID Signaling:** NXDN ID is an optional signaling system available only for digital communications.

## TIME-OUT TIMER (TOT)

The Time-out Timer is used to prevent you from using a channel for an extended duration. If you continuously transmit for a preset time, the transceiver will stop transmitting and an alert tone will sound. Release the **PTT** switch.

## BATTERY SAVER

The Battery Saver can be activated only on Conventional channels. This function decreases the amount of power used when a signal is not being received and no operations are being performed.

## KEY LOCK





Press the key programmed as **[Key Lock]** to lock and unlock the transceiver keys.

- The following keys still function when Key Lock is activated: Emergency, Backlight, Monitor, Monitor Momentary, Squelch Off, Squelch Off Momentary, Function, Key Lock, PTT

## LOW BATTERY WARNING





Your dealer can set an alert tone to sound and the LED indicator to blink red when the battery power is low. The battery power

icon displays the battery power remaining, as described in the table below. When the battery power is very low, recharge or replace the battery pack.

			
High	Sufficient	Low	Very low

## SIGNAL STRENGTH INDICATOR

The signal strength indicator displays the strength of received calls. No icon appears when no signal is available.

			
Strong	Sufficient	Weak	Very weak

 flashes when out of range (NXDN Trunking only).

## COMPANDER

If programmed by your dealer for a channel, the compander will remove excessive noise from transmitted signals, to provide higher clarity of signals.

---

**Note:** The COMPANDER is used only in analog operation.

---

## BUSY CHANNEL LOCKOUT (BCL)

On Conventional channels, if BCL is set up by your dealer, you will be unable to transmit if the channel is already in use. Use a different channel or wait until the channel becomes free.

If BCL Override has been programmed, you can transmit over the current signal:

- 1 Press and hold the **PTT** switch.
  - If the channel is already in use, a warning tone will sound.
- 2 Quickly release and then press the **PTT** switch again.
- 3 Speak into the transceiver as you would during a normal call.

## CONTROL CHANNEL HUNT

On NXDN Trunking channels, the transceiver automatically searches for a control channel.

- While searching for a control channel, the antenna icon will flash and no signals can be received.

## PTT ID

PTT ID is the transceiver unique ID code which is sent each time the **PTT** switch is pressed and/or released.

---

**Note:** PTT ID can be made only in analog operation.

---

## VOICE ANNOUNCEMENT

When changing the zone, channel, and/or group, an audio voice will announce the new zone, channel and group number.



**KENWOOD**

**CE 0035  
0168** 