



Preface

Thank you for purchasing Hytera DMR digital mobile radio. As a product built to the DMR standard, the mobile radio is endowed with ergonomic design and comprehensive digital functions to deliver an advanced communication solution. With it, you can make use of digital functions to top the competition!

To derive optimum performance from your radio, please read this manual and the supplied Safety Information Booklet carefully before use.

Icon Information

The following icons are available through this manual:

Alert Icons



Caution: indicates situations that could cause damage to your radio.



Note: indicates tips that can help you make better use of your radio.

Function Icons



: indicates functions that are available on digital channel only.



: indicates functions that are available on analog channel only.

Functions marked with no function icons are available on both analog and digital channels.

Term Explanation

Key Operation

Short press: to press a key and release it quickly;

Long press: to press a key and remain holding it down for a predefined period (2 seconds by default);

Hold down: to press a key and remain holding it down.

Private Call

Private call is initiated by a single user to another user, involving the calling party and the called party only.

Group Call

Group call is initiated by a single user to a group, involving the calling party and all the group members.

All Call

All call is a call initiated to all the users on a channel. It is used to deliver important notices.

Squelch

This technology can remove excessive background noises, improving your communication quality.

Copyright Information

Hytera and HYT are trademarks or registered trademarks of Hytera Communications Co., Ltd. in the PRC and/or other countries or areas. Hytera retains the ownership of its trademarks and product names. All other trademarks and/or product names that may be used in this manual are properties of their respective owners.

The Hytera product described in this manual may include Hytera computer programs stored in memory or other media. Laws in the PRC and/or other countries or areas preserve for Hytera exclusive rights for Hytera computer

programs. The purchase of this product shall not be deemed to grant, either directly or by implication, any rights to the purchaser with respect to Hytera computer programs. Any Hytera computer programs may not be copied, modified, distributed, decompiled, or reverse-engineered in any manner without the prior written consent of Hytera.

The AMBE+2™ voice coding technology embodied in this product is protected by intellectual property rights including patent rights, copyrights and trade secrets of Digital Voice Systems, Inc.

This voice coding technology is licensed solely for use within this product. The user of this technology is explicitly prohibited from attempting to decompile, reverse engineer, or disassemble the Object Code or in any other way convert the Object Code into a human readable form.

U.S. Patent Nos. #6,912,495 B2, #6,199,037 B1, #5,870,405, #5,826,222, #5,754,974, #5,701,390, #5,715,365, #5,649,050, #5,630,011, #5,581,656, #5,517,511, #5,491,772, #5,247,579, #5,226,084 and #5,195,166.

Disclaimer

Hytera endeavors to achieve the accuracy and completeness of this manual, but no warranty of accuracy or reliability is given. All the specifications and designs

are subject to change without notice due to continuous technology development. No part of this manual may be copied, modified, translated, or distributed in any manner without the express written permission of Hytera.

If you have any suggestions or would like to learn more details, please visit our website at <http://www.hytera.cn>.

RF Energy Exposure Compliance

Your radio is designed and tested to comply with a number of national and international standards and guidelines (listed below) regarding human exposure to radio frequency electromagnetic energy. This radio complies with the IEEE and ICNIRP exposure limits for occupational/controlled RF exposure environment at operating duty factors of up to 50% transmitting and is authorized by the FCC for occupational use only. In terms of measuring RF energy for compliance with the FCC exposure guidelines, your radio radiates measurable RF energy only while it is transmitting (during talking), not when it is receiving (listening) or in standby mode.

Your radio complies with the following of RF energy exposure standards and guidelines

- United States Federal Communications Commission,

Code of Federal Regulations; 47CFR part 2 sub-part J

- American National Standards Institute (ANSI)/Institute of Electrical and Electronic Engineers (IEEE) C95. 1-1992
- Institute of Electrical and Electronic Engineers (IEEE) C95. 1-1999 Edition
- International Commission on Non-Ionizing Radiation Protection (ICNIRP) 1998

Operational Instructions and Training Guidelines

To ensure optimal performance and compliance with the occupational/controlled environment RF energy exposure limits in the above standards and guidelines, users should transmit no more than 50% of the time and always adhere to the following procedures:

Transmit and Receive

To transmit (talk), push the Push-To-Talk (PTT) key; to receive, release the PTT key.

FCC Licensing Information

Part 15 Compliance

This equipment has been tested and found to comply with the limits for a Class B digital device, pursuant to part 15 of the FCC Rules. These limits are designed to provide reasonable protection against harmful interference in a residential installation. This equipment generates, uses





and can radiate radio frequency energy and, if not installed and used in accordance with the instructions, may cause harmful interference to radio communications. However, there is no guarantee that interference will not occur in a particular installation. If this equipment does cause harmful interference to radio or television reception, which can be determined by turning the equipment off and on, the user is encouraged to try to correct the interference by one or more of the following measures:

- Reorient or relocate the receiving antenna.
- Increase the separation between the equipment and receiver.
- Connect the equipment into an outlet on a circuit different from that to which the receiver is connected.
- Consult the dealer or an experienced radio/TV technician for help.

FCC Licensing Requirements

A license from Federal Communications Commission is required prior to use. Your dealer will program each radio with your authorized frequencies, signaling codes, etc., and will be there to meet your communications needs as your system expands. Contact your dealer for more information.

Contents

Checking Items in the Package	1	Zone	13
Radio Overview	2	Settings	13
Front Panel	2	Functions and Operations	16
Rear Panel	2	Standby Screen	16
Programmable Keys	2	Scan	16
Installation	4	Public Address	16
Status Indicators	6	Talk Around	17
LCD Icons	6	Monitor 	17
LED Indicator	7	Squelch Off 	17
Basic Operations	8	Emergency	18
Turning the Radio On/Off	8	Ignition Sense	20
Adjusting the Volume	8	Busy Channel Lockout	21
Selecting a Zone	8	Time-out Timer (TOT)	21
Selecting a Channel	8	Troubleshooting	22
Digital/Analog Switch	8	Care and Cleaning	24
Call	9	Optional Accessories	25
Menu Navigation	11	Appendix Input Method	26
Contact 	11		
Message 	11		
Call Logs 	12		
Scan	12		

Checking Items in the Package

Please unpack carefully and check that all items listed below are received. If any item is missing or damaged, please contact your dealer.

1 Radio Unit

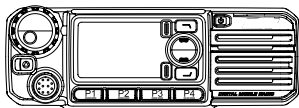

2 Palm Microphone

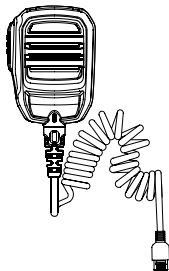

3 Microphone Hanger and Screws

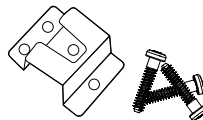

4 Power Cord

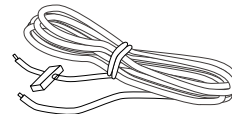

5 Mounting Bracket Kit

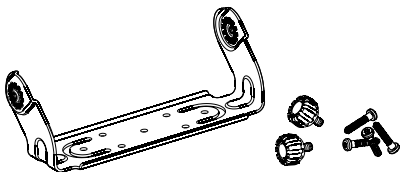

6 Fuse



7 Owner's Manual /Quick Reference Guide/Safety Information Booklet

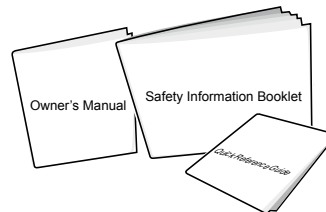

Radio Overview

Front Panel

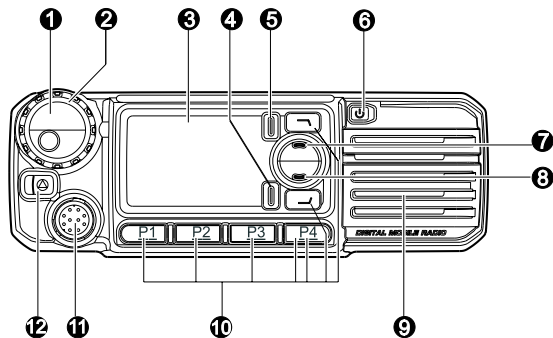

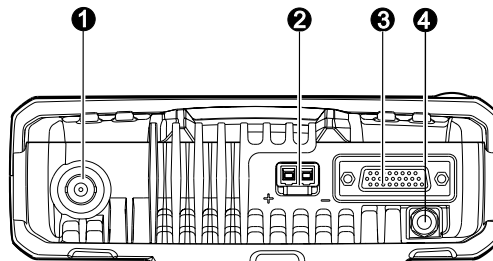

No.	Part Name	No.	Part Name
1	Volume Control / Channel Selector Knob	2	LED Indicator
3	LCD Display	4	OK/Menu Key
5	Back Key	6	Power On/Off key
7	Up Key	8	Down Key
9	Speaker	10	Programmable Keys
11	Microphone Jack	12	Emergency Key

Rear Panel











No.	Part Name	No.	Part Name
1	BNC Antenna Connector	2	Power Inlet
3	Accessory Jack	4	GPS Antenna Connector

Programmable Keys

For enhanced convenience, you may request your dealer to program the keys P1, P2, P3, P4, Emergency key,  and  as shortcuts to the functions listed below:

Radio Overview

No.	Shortcut Keys	Description
1	Zone Up	Quick access to desired zone
2	Zone Down	Quick access to desired zone
3	Message 	Quick access to the menu "Message"
4	Contact List 	Quick access to Contact List
5	Call Log 	Quick access to the menu "Call Logs"
6	Adjusting Power Level	To adjust power level through one button press.
7	Public Address	To allow public addressing via the external speaker.
8	Talk Around	To directly communicate with other radios.
9	Monitor 	To adjust the condition for incoming signal match.
10	Monitor Momentary 	To adjust the condition for incoming signal match.
11	Squelch Off 	To always unmute speaker no matter whether carrier is present or not.
12	Squelch Off Momentary 	To always unmute speaker no matter whether carrier is present or not.
13	Home Screen	To quickly return to the previous menu or the home screen.
14	Scan	To receive signals on other channels.
15	Nuisance Temporary Delete	To temporarily ignore unwanted channel activity.
16	Emergency	To summon help in emergent situations.
17	Adjusting Squelch Level 	To temporarily adjust the squelch threshold required for the radio to unmute.



Note: Long and short press of a key can be assigned with different functions by your dealer.

Installation

Before you install the radio in a vehicle, be sure to read the following instructions carefully:

Instructions

- The radio operates with negative grounded power supply of $13.2\pm 15\%V$ only. Please check polarity and voltage of the power supply on vehicle before you install the radio.
- Please check how long the screws will extend from the bottom surface of radio, before you install the radio. Be sure to drill mounting hole with caution, to avoid damage of the vehicle wiring and parts.
- Please connect the supplied antenna and power cord to the radio, before you install the radio in the bracket.
- Install the radio with Hytera supplied mounting bracket, to avoid radio loose in case of accidents. The loose radio may cause bodily injury.
- Install the radio in a location where it's easy to reach the front panel controls.
- Please make sure there's sufficient space at back of the radio for wiring.
- When the fuse for DC power cord needs replacement, it must be replaced by a fuse with the same specification.

Installation Tools

- Electric drill
- Cross head screwdriver
- Hex socket sleeve (used for 4.8*20mm self-tapping screws)

Installation

Installation Steps

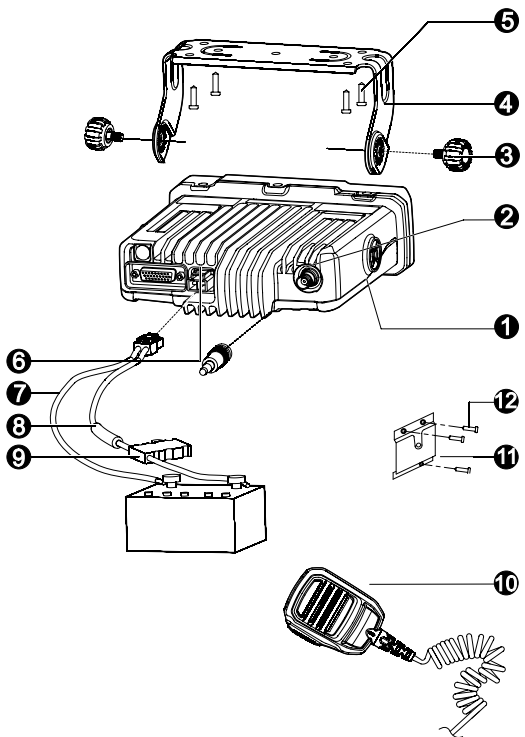

A Install the bracket in a location where it's easy to operate the radio.

B Connect accessories such as antenna and power cord to the radio.

C Slide the radio into the mounting bracket and secure it using the locking knobs.

D Install the microphone hanger in a location where it's easy to reach the microphone.

E Plug the palm microphone into the microphone jack on the front panel, and place it on the hanger when you do not use it.

No.	Part Name
1	Radio Unit
2	BNC Antenna Connector
3	Locking Knobs
4	Mounting Bracket
5	4.8 * 20 mm Self-tapping Screws
6	Power Inlet
7	Black Power Cord
8	Red Power Cord
9	Fuse
10	Palm Microphone
11	Microphone Hanger
12	4 * 16 mm Self-tapping Screws

Status Indicators

LCD Icons

The LCD of your radio displays the radio status, text entries, and menu items. The following are the icons that appear on the radio's display.

■ Standby Interface

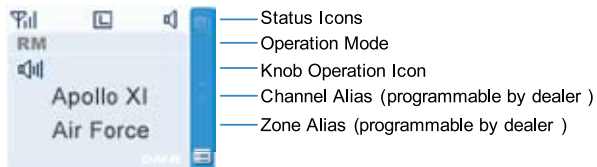



■ Status Icons

Icon Name	Icon	Radio Status
RSSI		No signal
		More bars indicate better signal strength
Message Icons		New Message/Unread Message
		Inbox is full

Scan Icons		Scanning is in progress
		Scanning pauses on a non-priority channel
		Scanning pauses on Priority Channel 1
		Scanning pauses on Priority Channel 2
Tx Power Icons		Low Tx power for the current channel
		High Tx power for the current channel
Monitor Icon		Monitor function is active
Speaker Icon		Speaker is unmuted
Emergency Icon		Emergency mode (other than secret emergency) is active or an emergency message is received
Knob Operation Mode Icons		The knob currently operates in channel selection mode
		The knob currently operates in volume adjustment mode

Status Indicators

■ Operation Mode Icons

Icon Name	Icon	Operation Mode
Operation Mode		Direct Mode: Under this mode, radios communicate with each other directly.
		Repeater Mode: Under this mode, radios communicate with each other via a repeater.

LED Indicator

The LED indicator will help you easily identify current radio status.

LED Indicator	Radio Status
LED flashes green	Powering on
LED glows red	Transmitting
LED glows green	Receiving
LED flashes orange	Scanning is in progress

Basic Operations

Turning the Radio On/Off

To turn the radio on, hold down the **Power On/Off** key until the following indications are given: the radio shows the power-up screen and sounds power-up alert, and LED flashes green.

To turn the radio off, long press the **Power On/Off** key.

Adjusting the Volume

When the **Volume Control / Channel Selector** knob operates in volume adjustment mode (the radio displays the icon ) , rotate the knob clockwise to increase the volume, or counter-clockwise to decrease the volume.

Alert tone volume is programmable by your dealer.

Selecting a Zone

A zone is a group of channels exhibiting the same property, and is programmed by your dealer. The radio supports up to 32 zones, each with a maximum of 16 channels. You may select a zone through any of the following methods:

1. Through menu selection

Go to the Zone menu, and use the **Up/Down** keys to select your desired zone.

2. Through the function keys

You may quickly toggle to your desired zone, through

press of the programmed **Zone Up** or **Zone Down** key.



Note: Your dealer may designate the power-up zone and channel. If not, the radio will enter the zone and channel last used.

Selecting a Channel

Press the **Volume Control / Channel Selector** knob to switch it to channel selection mode (the radio displays the icon ) , and then rotate the knob to select your desired channel.

Alias of the current channel will appear on the standby screen.



Note: The knob is in volume adjustment mode by default, and will return to this mode in 5 seconds after you select a channel.

Digital/Analog Switch

Each channel can be programmed as either analog channel or digital channel. If the current zone includes both analog and digital channels, you may quickly switch between digital and analog channels through the **Volume Control / Channel Selector** knob.

When switching from digital to analog mode, some features such as Message will be unavailable.

Call

■ Transmitting a Private Call

You may transmit a Private Call through any of the following methods. When transmitting a Private Call, the icon  will appear.

Transmitting a call to the preset contact

In standby mode, pressing **PTT** key will transmit an individual call to the contact (a Private Call number) preset for the current channel.



Note: Your dealer may preset a contact for each digital channel. The preset contact could be a Private Call number, a Group Call number or an All Call number.

Transmitting a call through Contact List or Call Logs

- 1 Go to Contact -> Contact List, or go to Call Logs -> Call List.
- 2 Use the **Up/Down** key to select the Private Call number you want to call.
- 3 Hold down **PTT** key to transmit a Private Call to the selected contact.

Transmitting a call through Manual Dial

- 1 Go to Contact -> Manual Dial.
- 2 Input a Private Call number you want to call.
- 3 Hold down **PTT** key to transmit a call.

■ Transmitting a Group Call

You may transmit a Group Call through any of the following methods. When transmitting a Group Call, the icon  will appear.

Transmitting a call to the preset contact

In standby mode, pressing **PTT** will transmit a Group Call to the contact (a Group Call number) preset for the current channel.

Transmitting a call through Contact List

- 1 Go to Contact -> Contact List.
- 2 Use the **Up/Down** key to select the Group Call number you want to call.
- 3 Hold down **PTT** to transmit a Group Call to the selected contact.

■ Transmitting an All Call



Methods are the same as those in Transmitting a Group Call. When transmitting an All Call, the icon  will appear.



Note: You can transmit an All Call only when it is enabled by your dealer.

■ Receiving and Responding to a Call

Receiving a Call

When a call is received, your radio will display the corresponding icon as follows:  for a Private Call,  for a Group Call and  for an All Call.

Responding to a Private/Group Call

After a Private Call or Group Call is received, you may press the **PTT** key within the preset time period to call back.

If you do not respond to a received Private Call, the radio will display the missed call icon .



Note: You cannot respond to an All Call.

■ Calls on Analog Channels

To transmit on an analog channel, hold down the **PTT** and speak into the microphone. To receive, release the **PTT**.

Menu Navigation

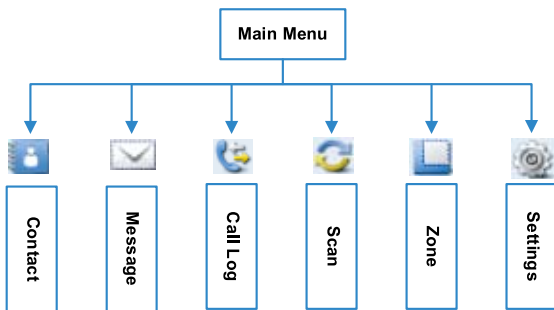

Contact

To access this item, press Menu key in idle mode and then select “Contact”.

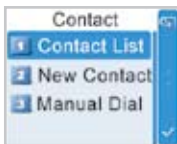

■ Contact List

You can save up to 200 entries in the list. To access this item, select “Contact -> Contact List” or press the shortcut key for Contact List.

Editing a Contact

You can edit the number and alias of each private contact.

Viewing a Contact

You can view details of each contact.

Deleting a Contact

You can delete a Private Call contact. However, please note that you can not delete the contact when there is only one entry left in the list. In addition, the individual contact preset on the digital channel cannot be deleted either.

■ New Contact

You can add a Private Call contact to the contact list. The available contact number is 1 to 16776415.

■ Manual Dial

You can manually input the Private Call number for calling.

Message

To access this item, press Menu key in idle mode and then select “Message”, or press the shortcut key for Message directly.



Menu Navigation

■ New Message

You can create your desired text message (256 characters at most) and send it to an individual user or to a talk group.

■ Quick Text

Under this option there are some text messages (10 entries at most) preset by your dealer. You can choose to edit and send any entry.

■ Inbox

The inbox can save up to 20 received messages. When the inbox is full, the icon  will appear.

For each message, you can choose to perform any of these operations: Reply, Forward, View Details and Delete.

To delete all messages in the inbox, select "Message -> Inbox -> Delete All".

■ Outbox

The outbox can save up to 20 sent messages. When the outbox is full, the oldest entry will be overwritten by the latest one automatically.

For each message, you can choose to perform any of these operations: Resend, Forward, View Details and Delete.

To delete all messages in the outbox, select "Message -> Outbox -> Delete All".

Call Logs

To access this item, press **Menu** key in idle mode and then select "Call Logs", or press the shortcut key for Call Log directly.

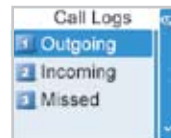

This radio can save up to 10 entries in the lists Outgoing calls, Incoming calls and Missed calls respectively. When the memory for call log is full, the oldest entry will be overwritten by latest one automatically.

After accessing a list and selecting an entry, you can perform any of these operations: hold down the **PTT** key to initiate a call; add it to Contact List; or delete it.

Scan

To access this item, press **Menu** key in idle mode and then select "Scan".



■ Scan On/Off

The feature “Scan” allows you to listen to communication activities on other channels so that you can keep a close track of your team members. This option is used to enable or disable the function.

■ Scan List

You can request your dealer to create a scan list for each channel. Each list may contain 32 channels at most (either digital channel or analog channel is OK). After accessing the list, you can perform any of the following operations:

Adding a Channel

To include a new channel into the active scan list.

Editing Priority Channel

To set the selected channel as a non-priority or as a priority channel. If you are interested in activities on a channel, you can set it as a priority channel, which will be scanned more frequently than a non-priority channel.

Each scan list may contain two priority channels at most.

P1 indicates priority channel 1, and **P2** indicates priority channel 2.

Deleting a Channel

To remove a channel from the active scan list. However, the first channel in the list can not be deleted.

Zone

To access this item, press **Menu** key in idle mode and then select “Zone”.



After accessing this menu, press **Up/Down** key to select your desired zone, and then press **OK** key to apply your selection.

Settings

To access this item, press **Menu** key in idle mode and then select “Settings”.



You can optimize your radio performance by customizing related parameters according to actual needs and your preferences.

■ Radio Setting

(1) Brightness



This option allows you to set the display brightness. You can increase or lower it using the **Up** or **Down** key.

(2) Backlight

To set the backlight on or off. The duration after which the backlight will go out can be configured via the programming software.

(3) Power Level

This option allows you to set transmit power level. Alternatively, you can change the power level by pressing the shortcut key for Adjust Power Level in idle mode.

There are two levels available: High (indicated by ) and Low (indicated by ). High power level enables you to communication with farther team members.



Note: Power level should be set for each channel individually.

(4) Language

To set the language in which all interface information is displayed. At the moment, this radio only supports two

languages: Simplified Chinese and English.

(5) Squelch Level

This option allows you to select an appropriate squelch level. Alternatively, you can change the squelch level by pressing the shortcut key for Adjust Squelch Level in idle mode. There are three levels available:

The default squelch level is “Normal”, generally used in low noise environment.

Generally, “Tight” is used in high noise environment. It requires stronger signal for the radio to unmute.

If the squelch level is set to Open, the speaker will keep unmuted irrespective of the satisfaction of decoding conditions.

(6) Tone

This option allows you to set the following alert tones for your radio.

Radio Silent: to set whether the radio will give tone indication. If Silent On is selected, all alert tones will be disabled.

Talk Permit: to set whether the radio will give tone indication for transmission. The following options are available: Disable (no tone indication for transmission), Digital Only (tone indication for transmission on digital channels only), Analog Only (tone indication for

transmission on analog channels only), and Enable (tone indication for transmission on both analog and digital channels).

Private Ring: to set whether the radio will give tone indication when it receives a private call.

TextMsg Ring: to set whether the radio will give tone indication when it receives a message.

Keypad: to set whether the radio will give tone indication for a key press.

■ Radio Information

With this option, you can view the basic information of your radio, including serial number, radio model, firmware version and etc.

Functions and Operations

Standby Screen

The feature allows you to quickly return to the previous menu or the home screen.

Operation:





In the editing screen, press the programmed **Home Screen** key, and the radio exits the screen and returns to the previous menu immediately; in other screens, press the key, and the radio returns to the home screen immediately.

Scan

The feature “Scan” allows you to listen to communication activities on other channels so that you can keep a close track of your team members.

Operation:

1. To enable the feature, you can select “On” from the menu “Scan”; or
Press the programmed **Scan** key in standby mode; or
Switch to a channel for which the feature “Auto Scan” is enabled via the programming software.
2. After the feature is enabled, your mobile radio will scan according to the scan list set for the channel on which scanning starts. The scanning process is as follows:
 - During scanning, LCD displays icon , and LED flashes orange.

- When activities are detected on a channel, the mobile radio will stay on the channel to receive current activities. If your mobile radio stays on a non-priority channel, LCD will display icon ; if on Priority Channel 1 or Priority Channel 2, LCD will display icon  or icon  respectively.
 - If you don't want to hear activities on the channel, press the programmed **Nuisance Temporary Delete** key to remove the channel from the scan list temporarily.
 - If you want to continue staying on the channel, press the programmed **Monitor** or **Squelch Off** key during scan stay. 
3. To exit the scanning process, you can select “Off” from the menu “Scan”, or press the programmed Scan key again.

Public Address

This feature allows public addressing via the external speaker. After the feature is enabled, your voice will not be transmitted, but output via the external speaker (connected to the accessory jack on the rear panel) if you hold down the **PTT** key and speak.

Operation:

1. Press the programmed **Public Address** key to enable the feature.

Functions and Operations

2. Hold down the **PTT** key and speak into the microphone. Then your voice will be broadcasted clearly via the external speaker.
3. To disable the feature, press the function key again.



Note: When the feature is enabled, you cannot transmit or receive, nor can you enter the menu.

Talk Around

You can continue to communicate in DM mode by pressing the programmed **Talk Around** key, when your repeater malfunctions, or when your terminal is out of the repeater's range but within talking range of other terminals.

Operation:

Press the programmed **Talk Around** key to switch between DM mode and RM mode.





Note: Under DM mode, the two terminals must be within talking range of each other.

Monitor

To adjust match conditions for signal receiving, you can enable the feature "Monitor".



Operation:

- (1) Press the programmed **Monitor** key to enable the feature, and the mobile radio displays icon . To disable the feature, press this key again. Or
- (2) Hold down the programmed **Monitor Momentary** key to enable the feature, and the mobile radio displays icon . To disable the feature, release this key.

Squelch Off

If the feature "Squelch Off" is enabled, your mobile radio's speaker will keep unmuted no matter whether carrier is present.

Operation:

- (1) Press the programmed **Squelch Off** key to enable the feature. Then the mobile radio displays icon  and sounds background noise. To disable the feature, press this key again. Or
- (2) Press the programmed **Squelch Off Momentary** key to enable the feature. Then the mobile radio displays icon  and sounds background noise. To disable the feature, release this key.

Emergency

In case of an emergency, you can use the feature to ask for help from your companion or control center. The Emergency process has the highest priority. You can make emergency operation even when your mobile radio is transmitting or receiving.

To enable the feature on a channel, an emergency system must be assigned to the channel via the programming software. In addition, the Emergency type and Emergency mode are settable via the programming software.

■ Emergency Type

For each Emergency mode, there are four Emergency types available. You can select one of them via your dealer:





Emergency Type	Description
Siren Only	In Emergency mode, the mobile radio will sound shrill alarm tone and display the icon  .
Regular	In Emergency mode, the mobile radio will give audible and visible indication.

Silent	In Emergency mode, the mobile radio won't give any audible or visible indication.
Silent with Voice	In Emergency mode, the mobile radio won't give any audible or visible indication, but will receive voice Ack from the companion or control center automatically.

■ Emergency Mode

Your mobile radio supports three Emergency modes. You can select one of them via your dealer (Note: For the following operation methods, we take the "Regular" type as an example).

Emergency Mode	Description
 Emergency Alarm	In this mode, you can send alarm information to your companion or control center by pressing the programmed Emergency key, but you cannot talk with them.

Emergency Alarm with Call 	In this mode, you can send alarm information by pressing the programmed Emergency key. When icon  appears, you can speak into the microphone, allowing your voice and background noise to be transmitted automatically (you do not need to hold down the PTT key).
Emergency Alarm with Voice to Follow 	In this mode, you can press the programmed Emergency key to go to the Emergency Revert Channel. When icon  appears, you can speak into the microphone, allowing your voice and background noise to be transmitted automatically (you do not need to hold down the PTT key).

■ Operation Methods for Analog Emergency



Emergency Alarm



Operation: Press the programmed **Emergency** key to send alarm information. The mobile radio displays icon  and text information “Sending Alarm!”, with red LED glowing. If “Local Emergency Alarm” is enabled via the programming software, an alarm tone will sound.



Two methods are available for you to exit the Emergency mode:

1. Once the Alarm Cycles expire, the mobile radio will exit the Emergency mode automatically.
2. Long press the programmed **Emergency** key.

Emergency Alarm with Call

Operation:

1. Press the programmed **Emergency** key to send alarm information. The mobile radio displays icon  and text information “Sending Alarm!”, with red LED glowing. If “Local Emergency Alarm” is enabled via the programming software, an alarm tone will sound.
2. When icon  appears, you can speak into the microphone to make an emergency call.

- When icon  appears, you can receive. And when a call is received, the icon  appears.

Two methods are available for you to exit the Emergency mode:

- After the preset Alarm Cycles and Voice Cycles expire, the mobile radio will exit the Emergency mode automatically.
- Long press the programmed **Emergency** key.







Note: Your dealer may set the number of alarm cycles, alarm duration, number of voice cycles, duration of each transmission and Tx interval.



■ Operation Methods for Digital Emergency



Emergency Alarm with Voice to Follow

Operation:

- Press the programmed **Emergency** key to go to the Emergency Revert Channel. The icon  appears.
- When the icon  appears, you can speak into the microphone to make an emergency call.
- When the icon  appears, you can receive. And when a call is received, the icon  appears.

If the preset Voice Cycles expire, you can press the **PTT** key to make the emergency call again (the mobile radio displays the icon , with red LED glowing). After the emergency call is transmitted, please release the **PTT** key to receive (the icon  appears). When a call is received, the icon  appears.

To exit the Emergency mode, long press the programmed **Emergency** key.



Note: Your dealer may set the number of voice cycles, duration of each transmission and Tx interval.

Ignition Sense

The following options are available via the vehicle ignition. You may ask your dealer to assign any one to your mobile radio.

- **PTT Disable:** The **PTT** key is enabled or disabled by following the ignition sense.
Operation: To enable the **PTT** key, start the engine; to disable the **PTT** key, stop the engine.
- **Ignition or Switch:** The mobile radio powers on or off by following either the ignition sense or the **Power On/Off** key.

Functions and Operations

Operation: To power on the mobile radio, start the engine or hold down the **Power On/Off** key; to power it off, stop the engine or long press the **Power On/Off** key.

- **Ignition Only:** The mobile radio powers on or off by following the ignition sense only. The **Power On/Off** key does not work.

Operation: To turn on the mobile radio, start the engine; to turn it off, stop the engine (The **Power On/Off** key does not work).

Busy Channel Lockout

If enabled via the programming software, this feature can prevent your mobile radio interfering with other transmitting terminals on the same channel. If you hold down the **PTT** key while the channel is in use, your mobile radio will keep beeping and display text information “Channel Busy”, alerting you to transmission prohibition. To stop beeping, please release the **PTT** key. When the channel is free, you can press and hold down the **PTT** key to transmit.

Time-out Timer (TOT)

The purpose of TOT is to prevent any user from occupying a channel for an extended period. If the preset time expires, the mobile radio will automatically terminate

transmission and keep beeping. To stop beeping, please release the **PTT** key. You must wait for a certain time period (preset by your dealer) before you can press and hold down the **PTT** key to transmit again.

If the pre-alert function is set by your dealer, your mobile radio will alert you to the TOT expiration in advance.



Note: This feature is null in Emergency mode.

Troubleshooting

Phenomena	Analysis	Solution
The equipment can not be powered on.	The power cord may be unconnected.	Connect the power cord correctly.
During receiving signals, the voice is weak, discontinuous or totally inactive.	The volume may be set to a low level.	Increase the volume by rotating the Volume Control knob clockwise.
	The antenna may get loose or may be improperly installed.	Power off the radio, re-install the antenna and power on the radio again.
	The speaker may be blocked or damaged.	Clean surface of the speaker. If the problem can not be solved, contact your dealer or authorized service center for inspection and repair.
You can not communicate with other members in Analog mode.	The frequency or signaling may be inconsistent with that of other members.	Set your TX/RX frequency or signaling to the same as that of other members.
	You may be too far away from the group members.	Move towards other members. And make sure that you are within the communication range.
You can not communicate with other members in Digital mode although there is receiving indication.	Your ID may be inconsistent with that of other members. Consequently, the digital carrier can be received but can not be demodulated.	Set your ID to the same as that of other members.

Troubleshooting

Irrelevant communications or noises are heard on the analog channel.	You may be interrupted by radios using the same frequency.	Change the frequency, or adjust the squelch level.
	The radio may be set with no signaling.	Set your radio with signaling to avoid interference at the same frequency, and make sure that all members share the same signaling.
The noise is too loud.	You may be too far away from other members.	Move towards other members, power off your radio and then restart it.
	You may be at an unfavorable position. For example, your communication may be blocked by high buildings or frustrated in the underground areas.	Move to an open and flat area, and restart the radio.
	You may suffer from external disturbance such as electromagnetic interference.	Stay away from equipment that may cause interference.
You can not use the keys.	The keypad may fail to function temporarily.	Restart the radio.
There is no display.	The LCD may fail to function temporarily.	Restart the radio.

If the above solutions can not fix your problems, or you may have some other troubles, please contact us or your local dealer for more technical support.

Care and Cleaning

To guarantee optimal performance as well as a long service life of your mobile radio, please follow the tips below.

Radio Care

- Keep the mobile radio at a place with good ventilation and heat dissipation to facilitate normal work.
- Do not place irrelevant articles on top of the mobile radio to ensure optimal heat dissipation.
- Do not place the mobile radio in corrosive agents, solutions or water.

Radio Cleaning

- Clean up the dust and fine particles on the radio parts with a clean and dry lint-free cloth or a brush regularly.
- Use a non-woven fabric with neutral cleanser to clean the keys, control knobs, LCD and jacks after long-time use. Do not use chemical preparations such as stain removers, alcohol, sprays or oil preparations. Make sure the mobile radio is completely dry before use.



Caution: Power off the mobile radio before cleaning.

Optional Accessories

The following items are the main optional accessories for the radio, and please consult your local dealer for more other accessories.

Desktop Microphone SM10A1



External Speaker SM09D1



Programming Cable (USB Port) PC37



Data Cable PC40



Keypad Microphone SM19A1



Power Supply (320W) PS22002



Antenna



Note: Use the accessories specified by Hytera only. If not, Hytera shall not be liable for any losses or damages arising out of use of unauthorized accessories.

Appendix Input Method

You can enter aliases, numbers or messages using the keypad. This mobile radio supports the following input methods: Chinese Pinyin (simplified), English and Number.

■ Chinese Pinyin (Simplified)

Operation:

1. Press **#***, to switch to Chinese Pinyin mode;
2. Enter the pinyin through alphanumeric keys; then a list of possible combinations and corresponding characters will appear;
3. Use the **Up/Down** key to choose the right pinyin;
4. Press the **OK** key to highlight the characters, and choose the right character using the **Up/Down** key;
5. Press the **OK** key to enter the selected character.

You can repeat the above steps to continue.

■ English

Operation:

1. Press **#***, to switch between Uppercase and Lowercase English mode;
2. Enter the English letters through alphanumeric keys;
3. Use the **Up/Down** key to choose the right letter;
4. Press the **OK** key to enter the selected letter.

You can repeat the above steps to continue.

■ Number

Operation:

1. Press **#***, to switch to Number mode;
2. Enter the numbers through alphanumeric keys **0_** to **9 xyz**.

■ Special Character

To enter common punctuations and special characters, press **1<**.

To input a space, press ***+**.



Note: You can use the **Up/Down** key to move the cursor leftward/rightward in the entered text.